

Follow the above steps

Colour this accordingly

ক	খ	গ	ঘ	ঙ	চ	ছ	জ
ঝ	ঞ	ট	ঠ	ড	ঢ	ণ	ত
থ	দ	ধ	ন	প	ফ	ব	ভ
ম	য	র	ল	শ	ষ	স	হ
ড়	ঢ়	য়	ৌ	্	ৎ	৏	

Student Name: _____

Verified By: _____

Class: _____

Date: _____

Trace It

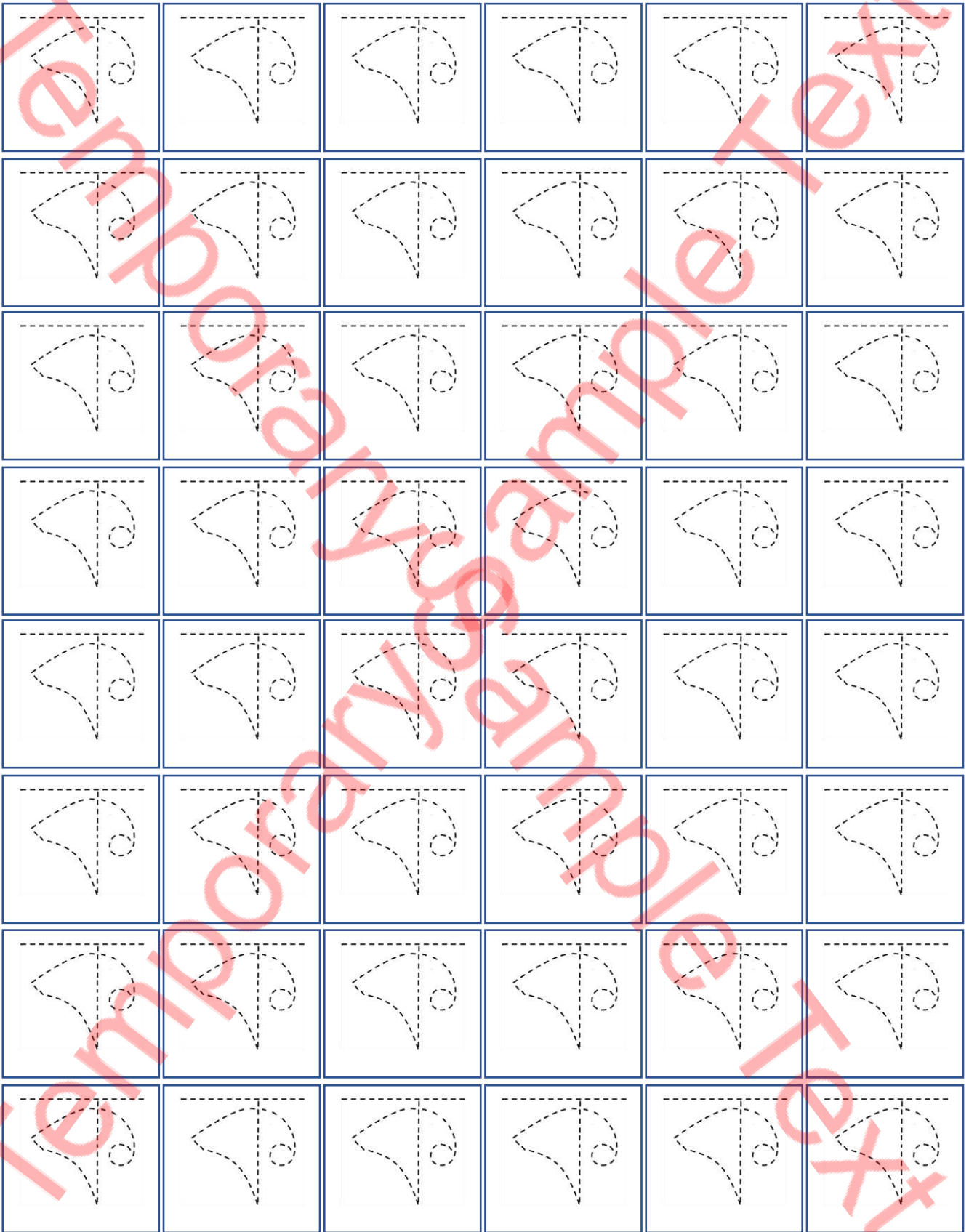

Student Name: _____

Verified By: _____

Class: _____

Date: _____

Trace it

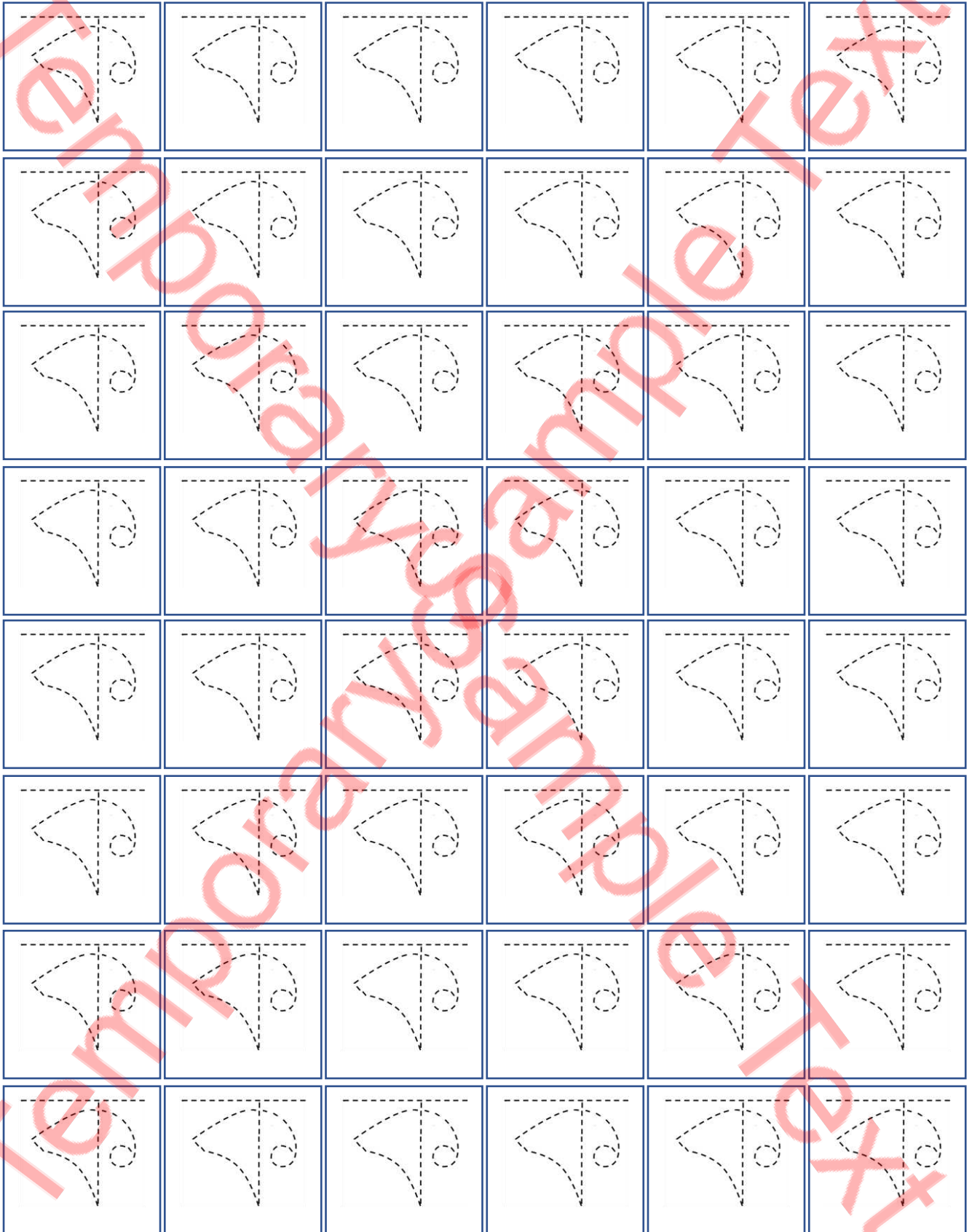

Student Name: _____

Verified By: _____

Class: _____

Date: _____

Write it

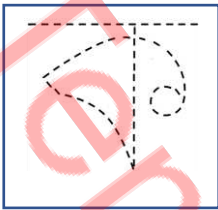
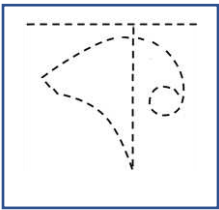
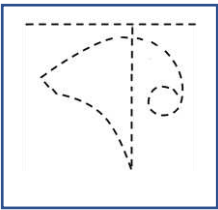
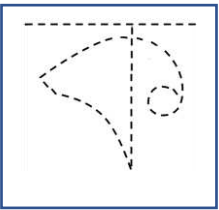
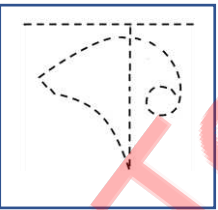
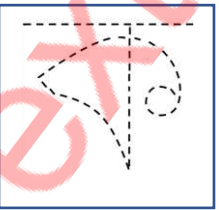
Student Name: _____

Verified By: _____

Class: _____

Date: _____

Copy Colour

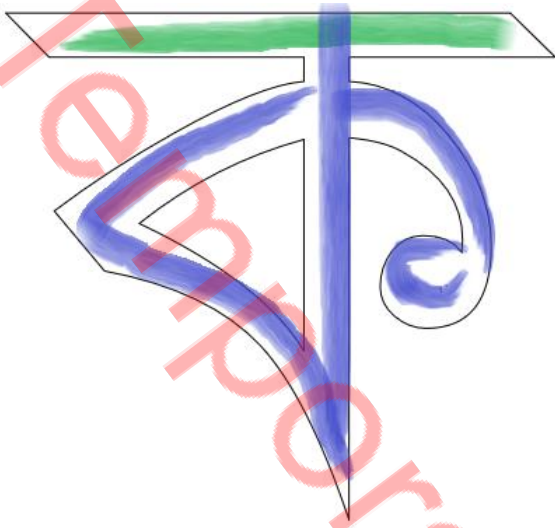

Colour it

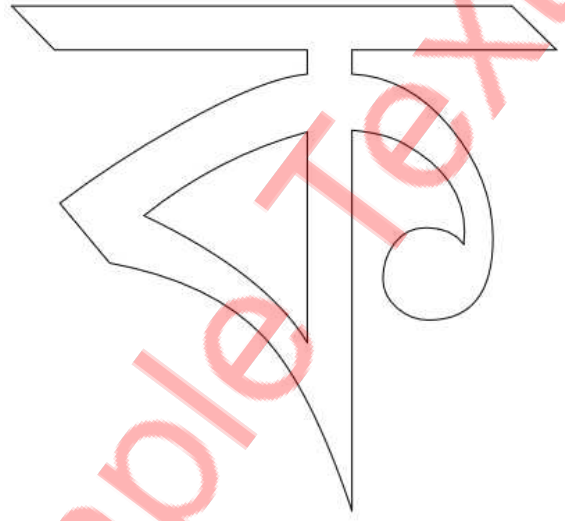

Write it

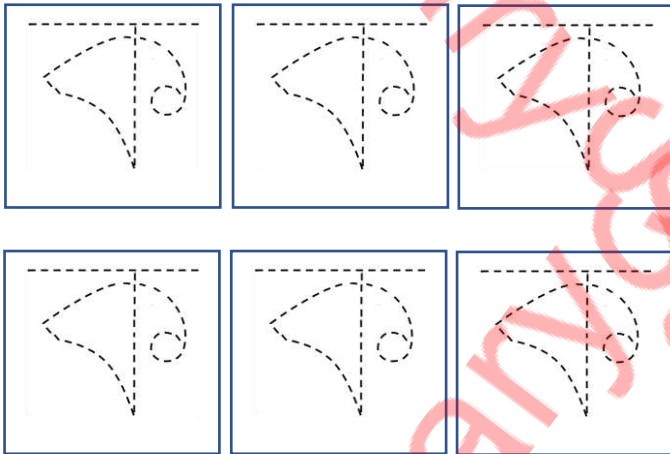

Find it

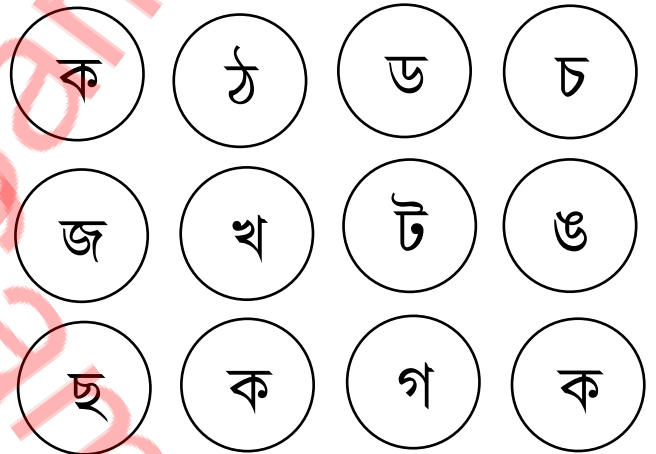

Connect the circle

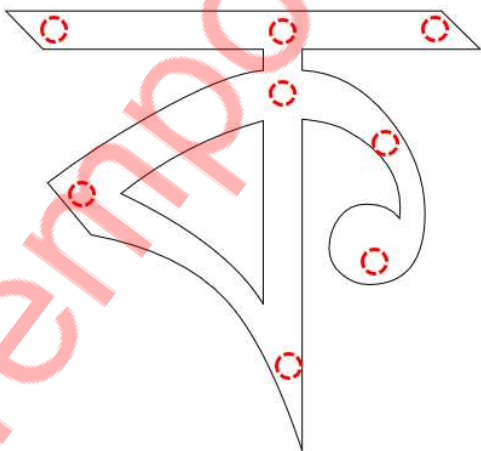

Do it

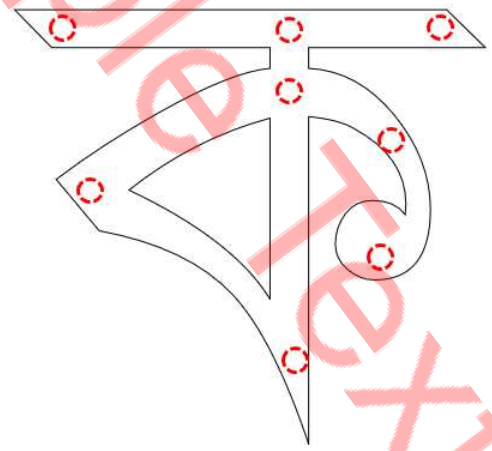

Student Name: _____

Verified By: _____

Class: _____

Date: _____

Pick the Path Find the Correct Alphabet

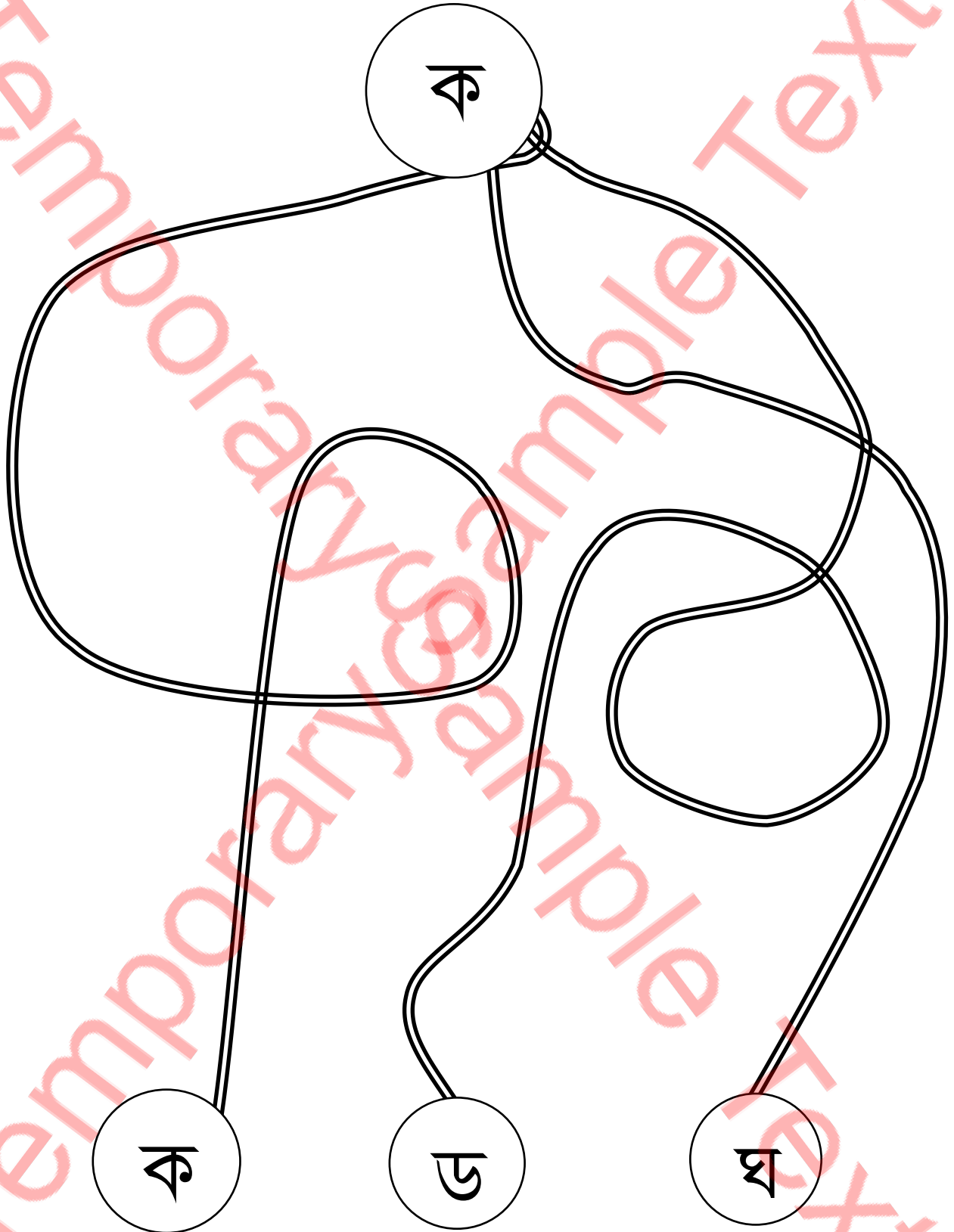

Student Name: _____

Verified By: _____

Class: _____

Date: _____

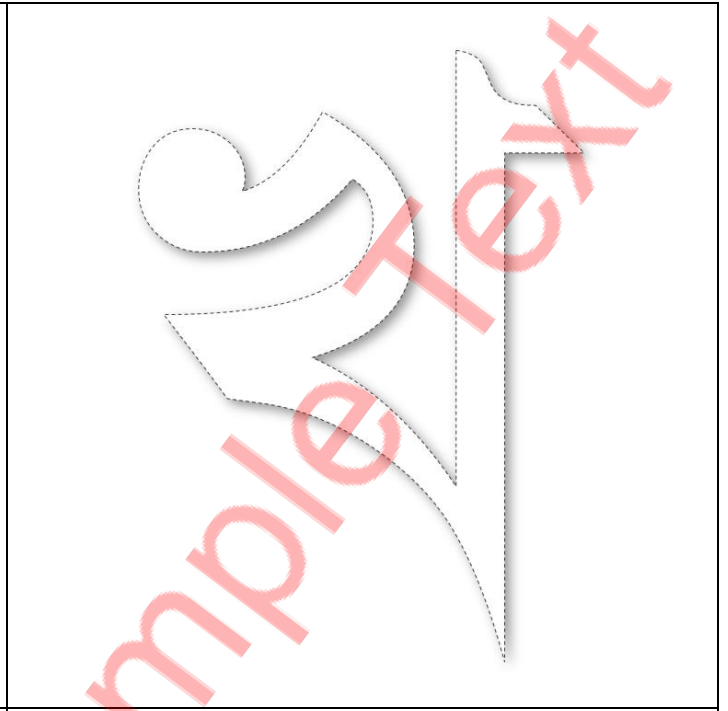
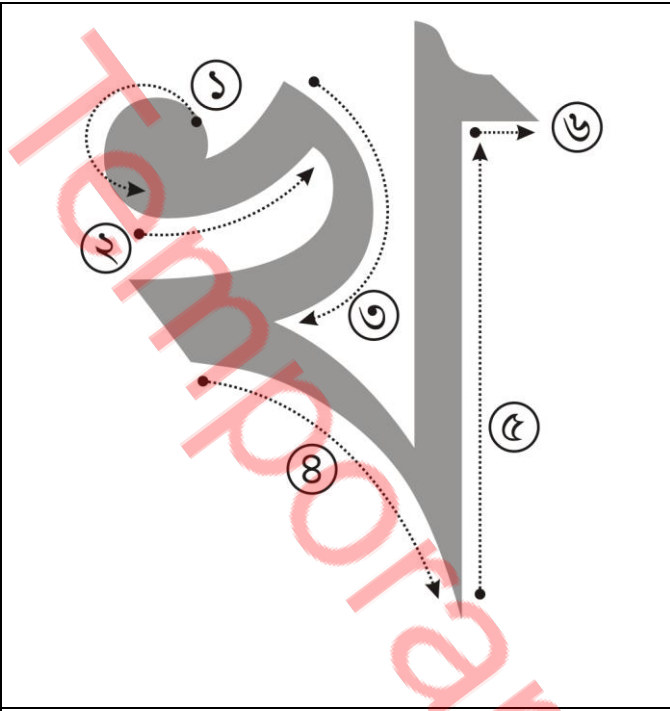

Follow the above steps

Colour this accordingly

ক	খ	গ	ঘ	ঙ	চ	ছ	জ
ঝ	ঞ	ট	ঠ	ড	ঢ	ণ	ত
থ	দ	ধ	ন	প	ফ	ব	ভ
ম	য	র	ল	শ	ষ	স	হ
ড়	ঢ়	য়	ৱ	৲	৳	৴	

Student Name: _____

Verified By: _____

Class: _____

Date: _____

Trace It

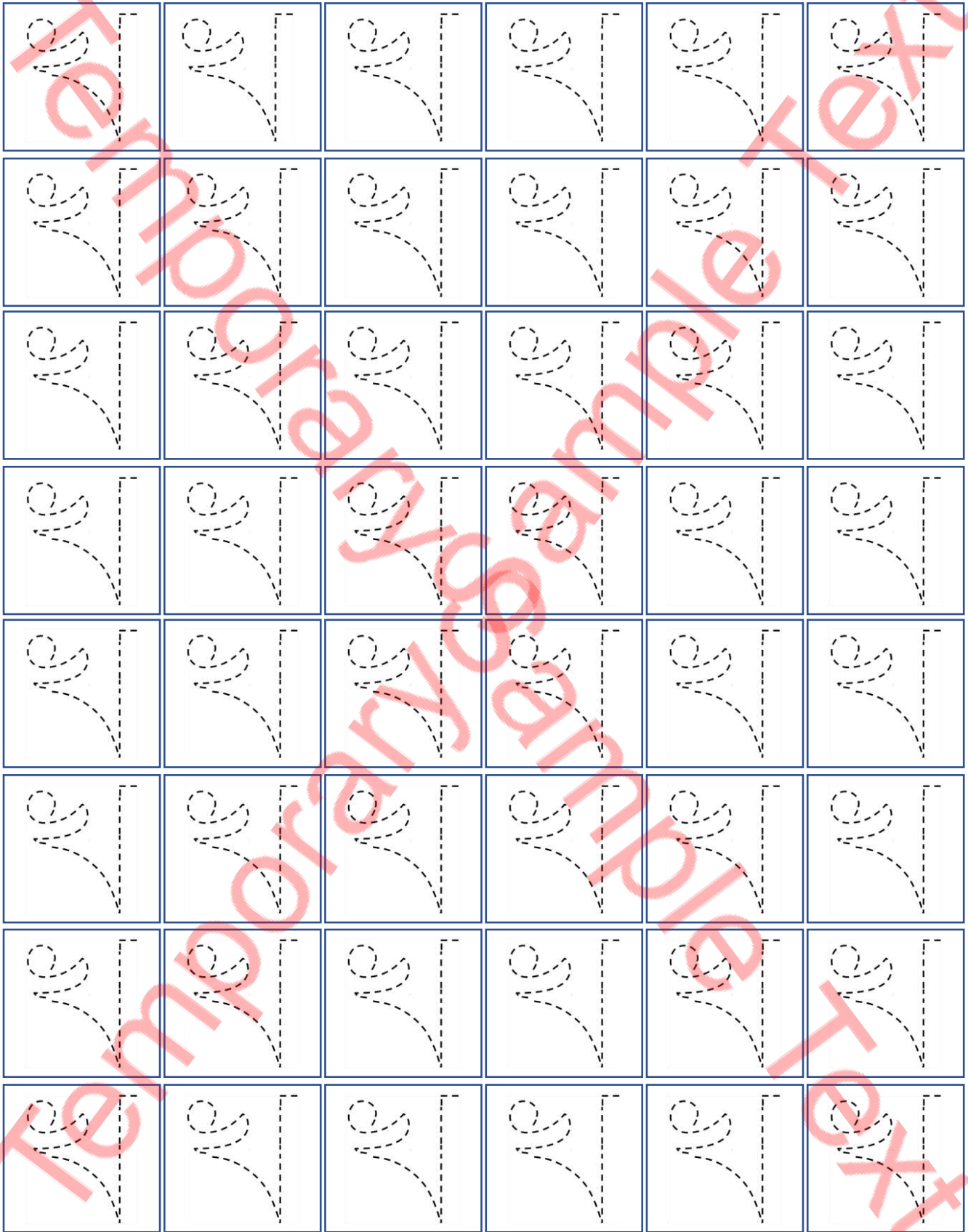

Student Name: _____

Verified By: _____

Class: _____

Date: _____

Trace it

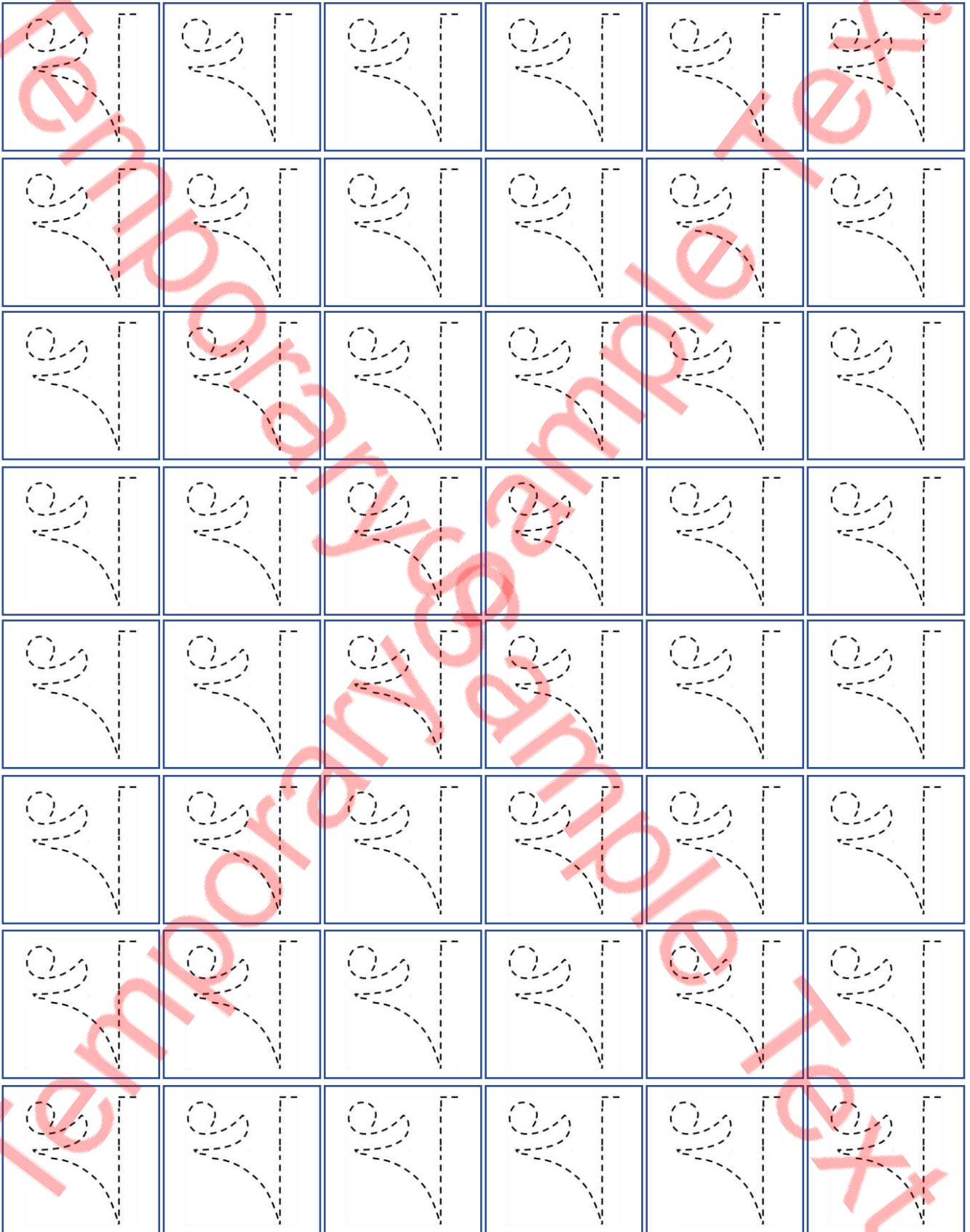

Student Name: _____

Verified By: _____

Class: _____

Date: _____

Write it

श	श	श	श	श	श

Student Name: _____

Verified By: _____

Class: _____

Date: _____

Copy Colour



Colour it



Write it

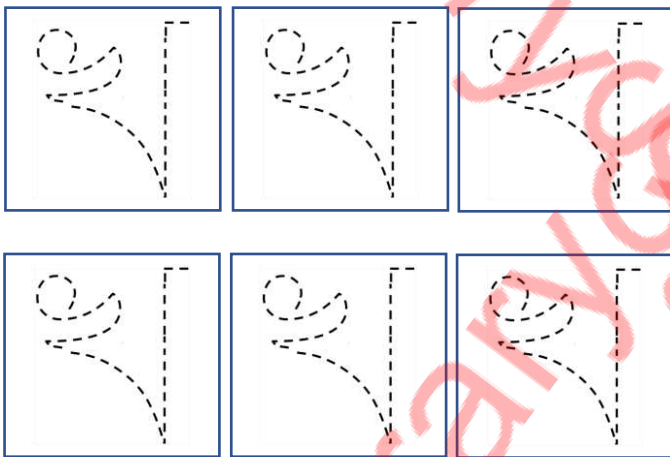

Find it

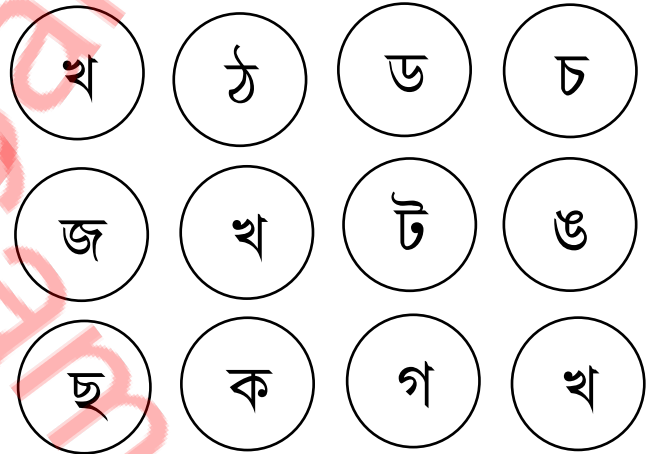

Connect the circle

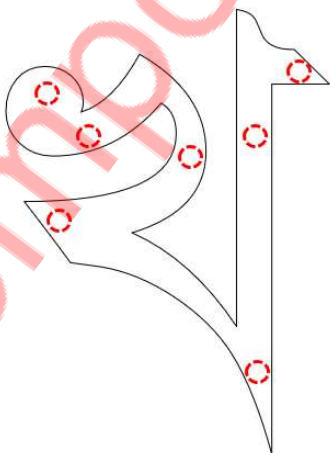

Do it

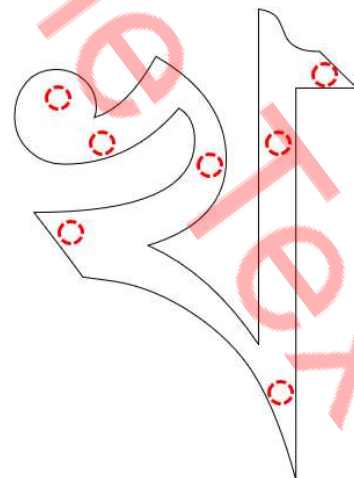

Student Name: _____

Verified By: _____

Class: _____

Date: _____

Pick the Path Find the Correct Alphabet

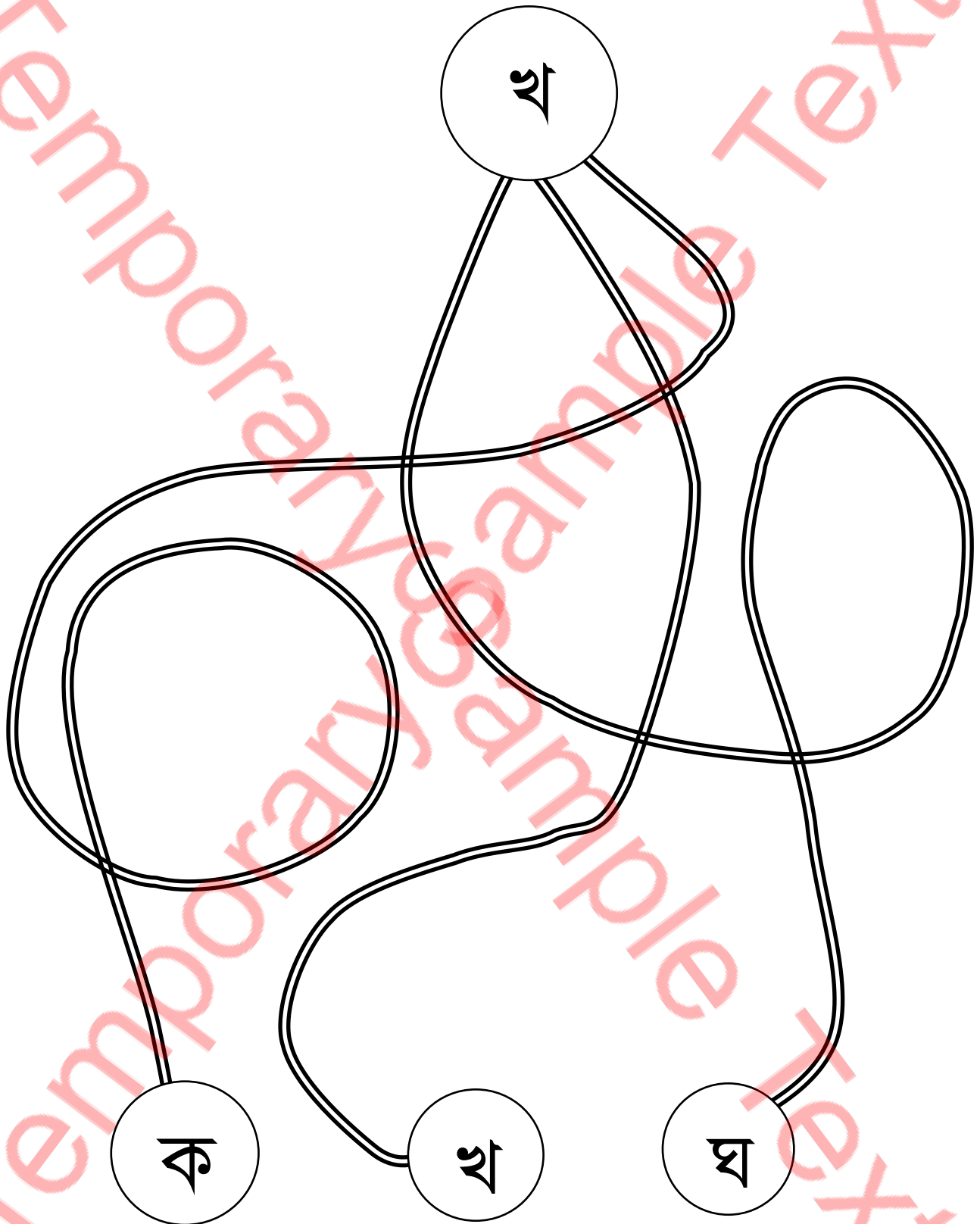

Student Name: _____

Verified By: _____

Class: _____

Date: _____

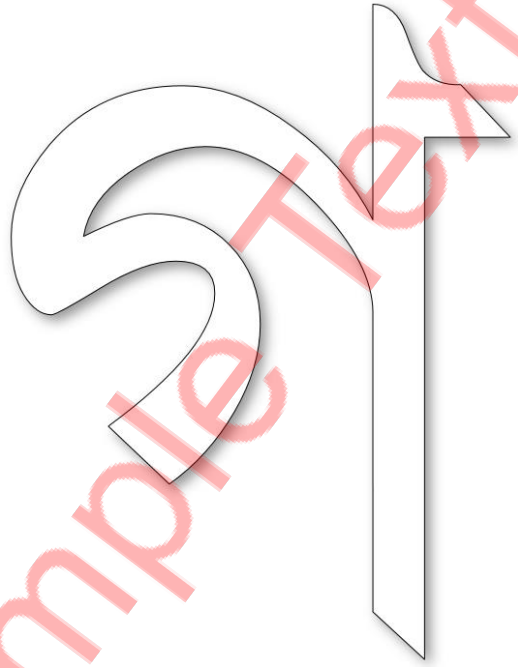
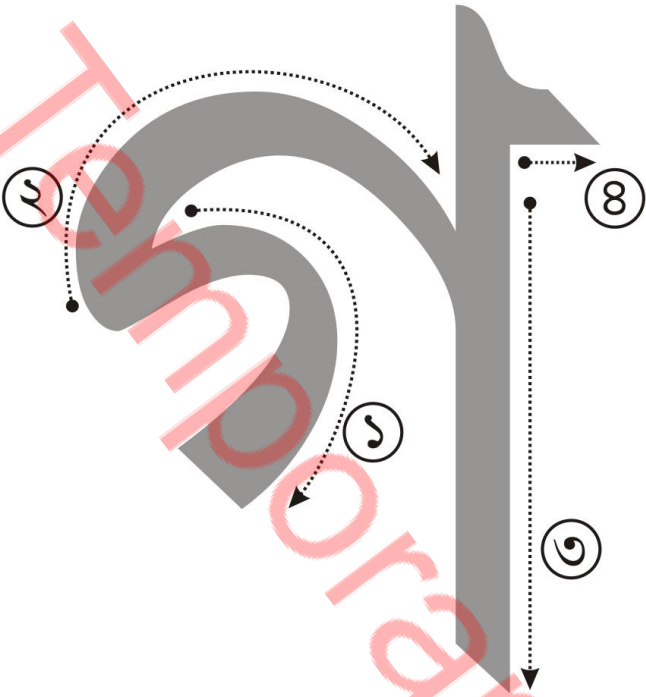

Follow the above steps

Colour it accordingly

ক	খ	গ	ঘ	ঙ	চ	ছ	জ
ঝ	ঞ	ট	ঠ	ড	ঢ	ণ	ত
থ	দ	ধ	ন	প	ফ	ব	ভ
ম	য	র	ল	শ	ষ	স	হ
ড়	ঢ়	য়	ৌ	্	ৎ	৏	

Student Name: _____

Verified By: _____

Class: _____

Date: _____

Trace It

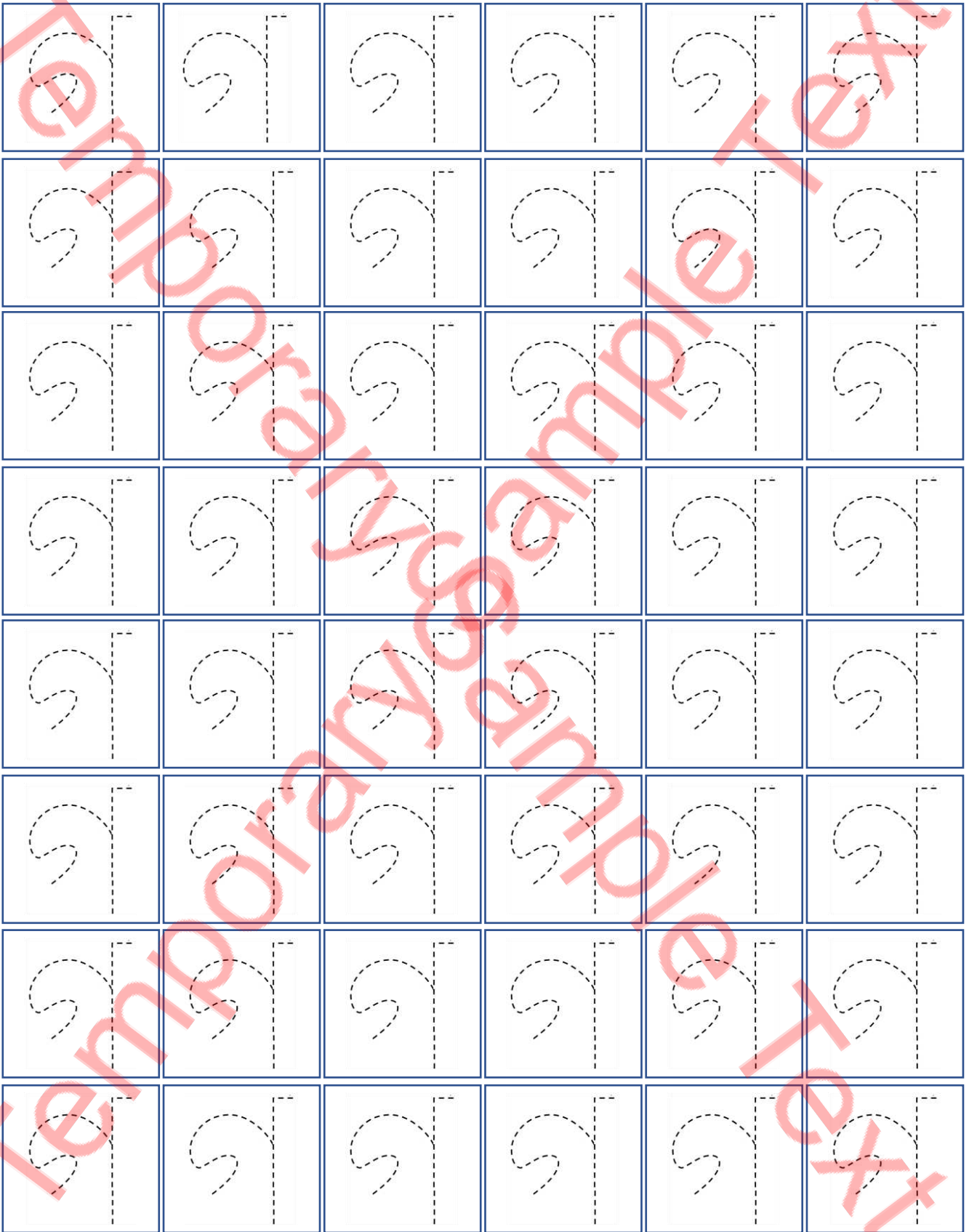

Student Name: _____

Verified By: _____

Class: _____

Date: _____

Trace it

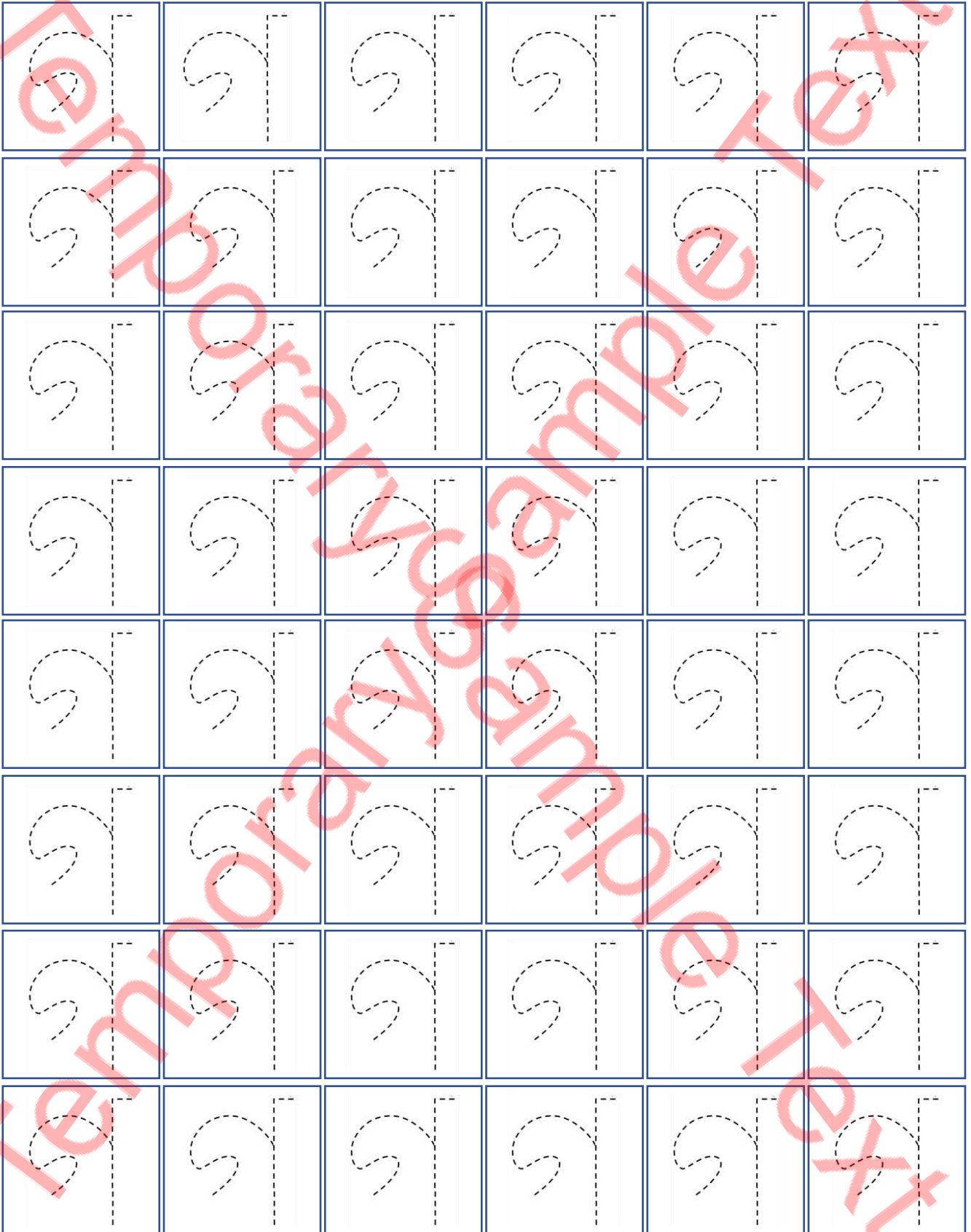

Student Name: _____

Verified By: _____

Class: _____

Date: _____

Write it

र	र	र	र	र	र

Student Name: _____

Verified By: _____

Class: _____

Date: _____

Copy Colour



Colour it

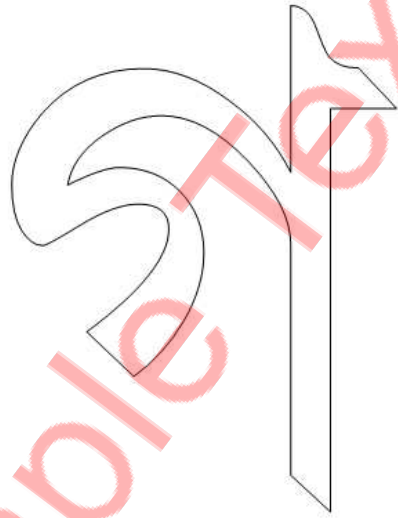

Write it

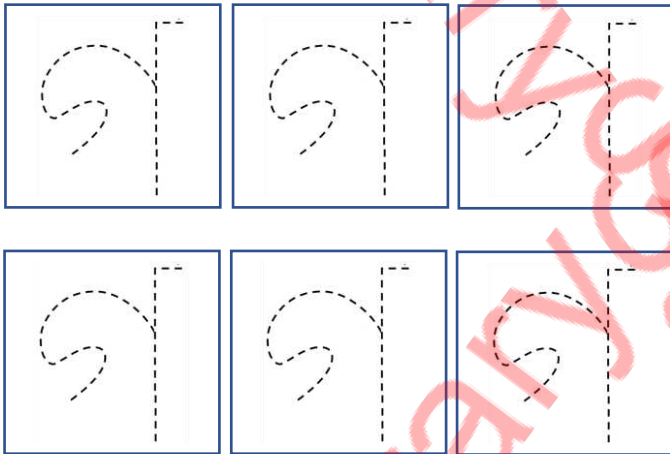

Find it

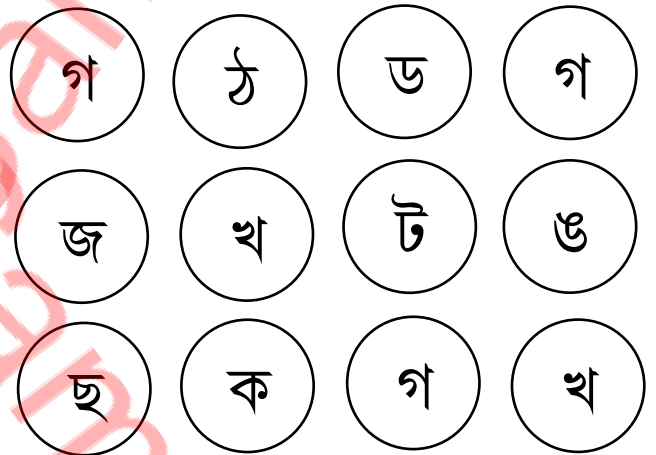

Connect the circle

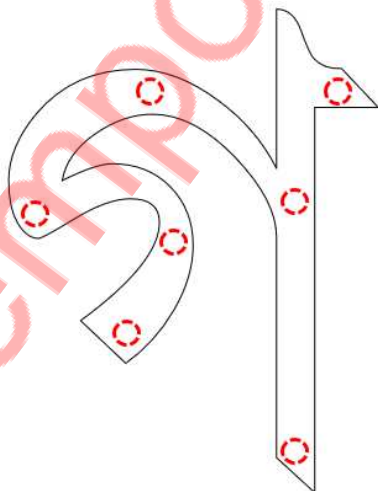

Do it

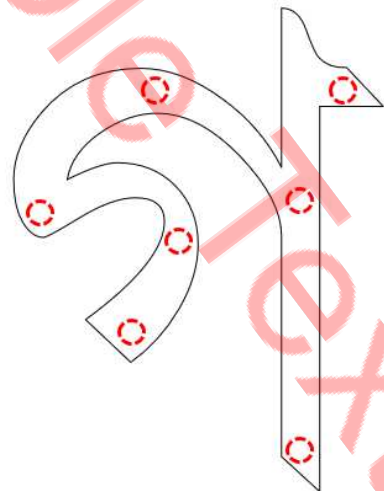

Student Name: _____

Verified By: _____

Class: _____

Date: _____

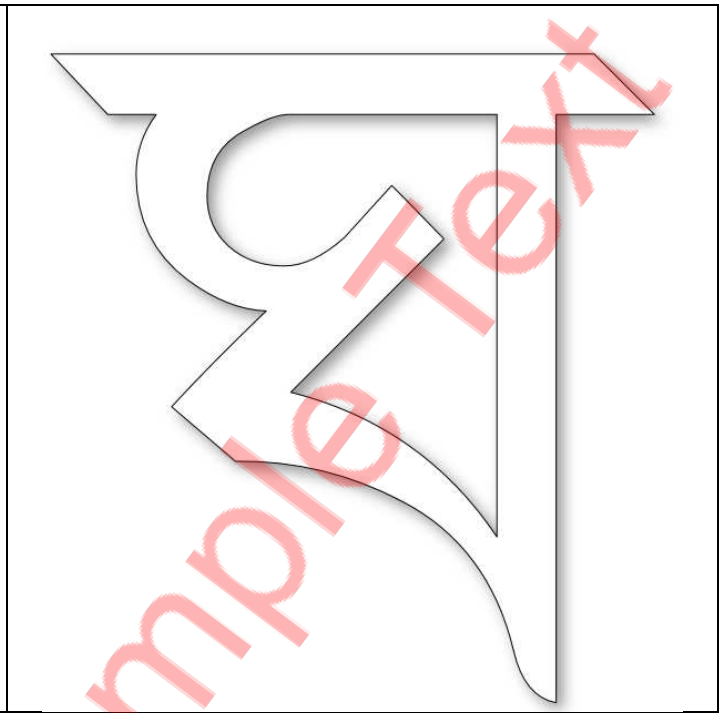
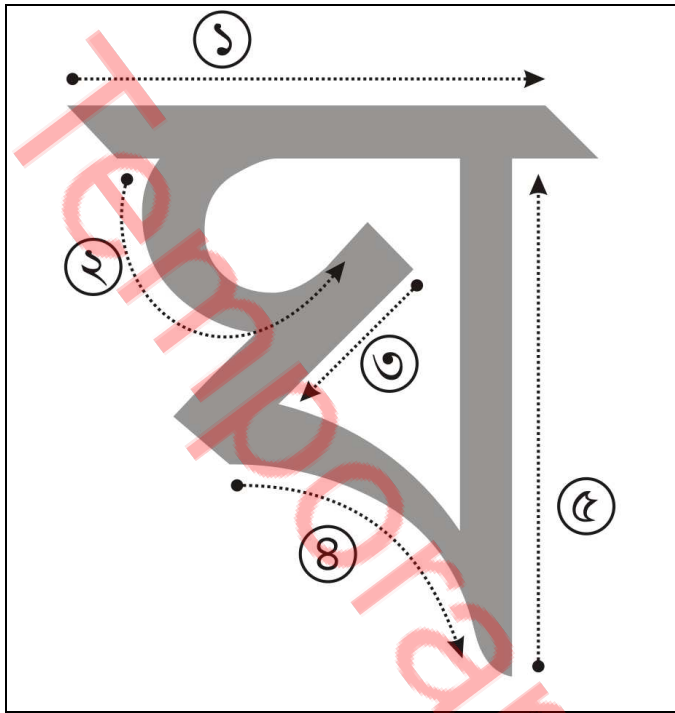

Follow the above steps

Colour it accordingly

ক	খ	গ	ঘ	ঙ	চ	ছ	জ
ঝ	ঞ	ট	ঠ	ড	ঢ	ণ	ত
থ	দ	ধ	ন	প	ফ	ব	ভ
ম	য	র	ল	শ	ষ	স	হ
ড়	ঢ়	য়	৐	৑	৒	৓	

Student Name: _____

Verified By: _____

Class: _____

Date: _____

Trace It



Student Name: _____

Verified By: _____

Class: _____

Date: _____

Trace it



Student Name: _____

Verified By: _____

Class: _____

Date: _____

Write it

Student Name: _____

Verified By: _____

Class: _____

Date: _____

Copy Colour



Colour it



Write it

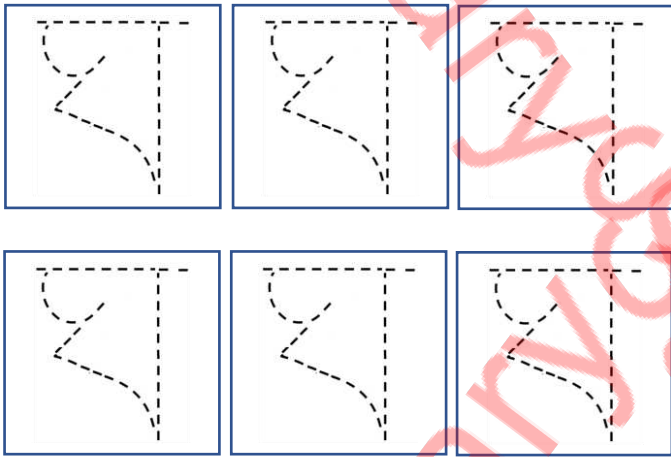

Find it

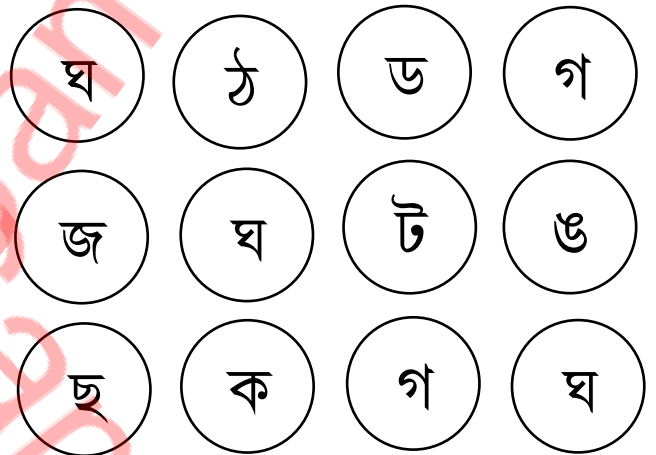

Connect the circle

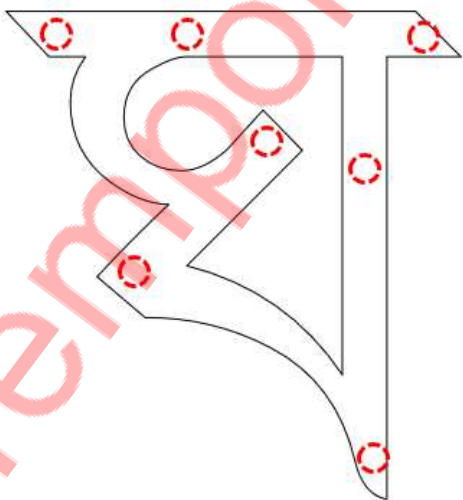

Do it

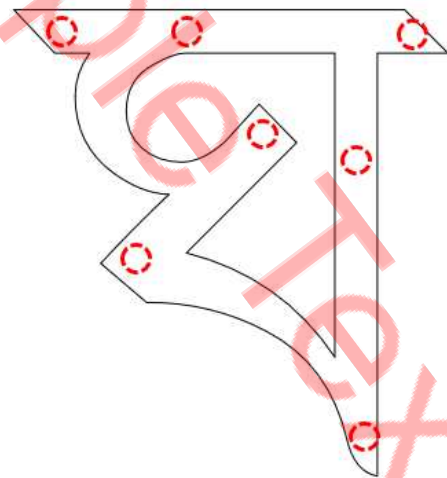

Student Name: _____

Verified By: _____

Class: _____

Date: _____

Pick the Path Find the Correct Alphabet

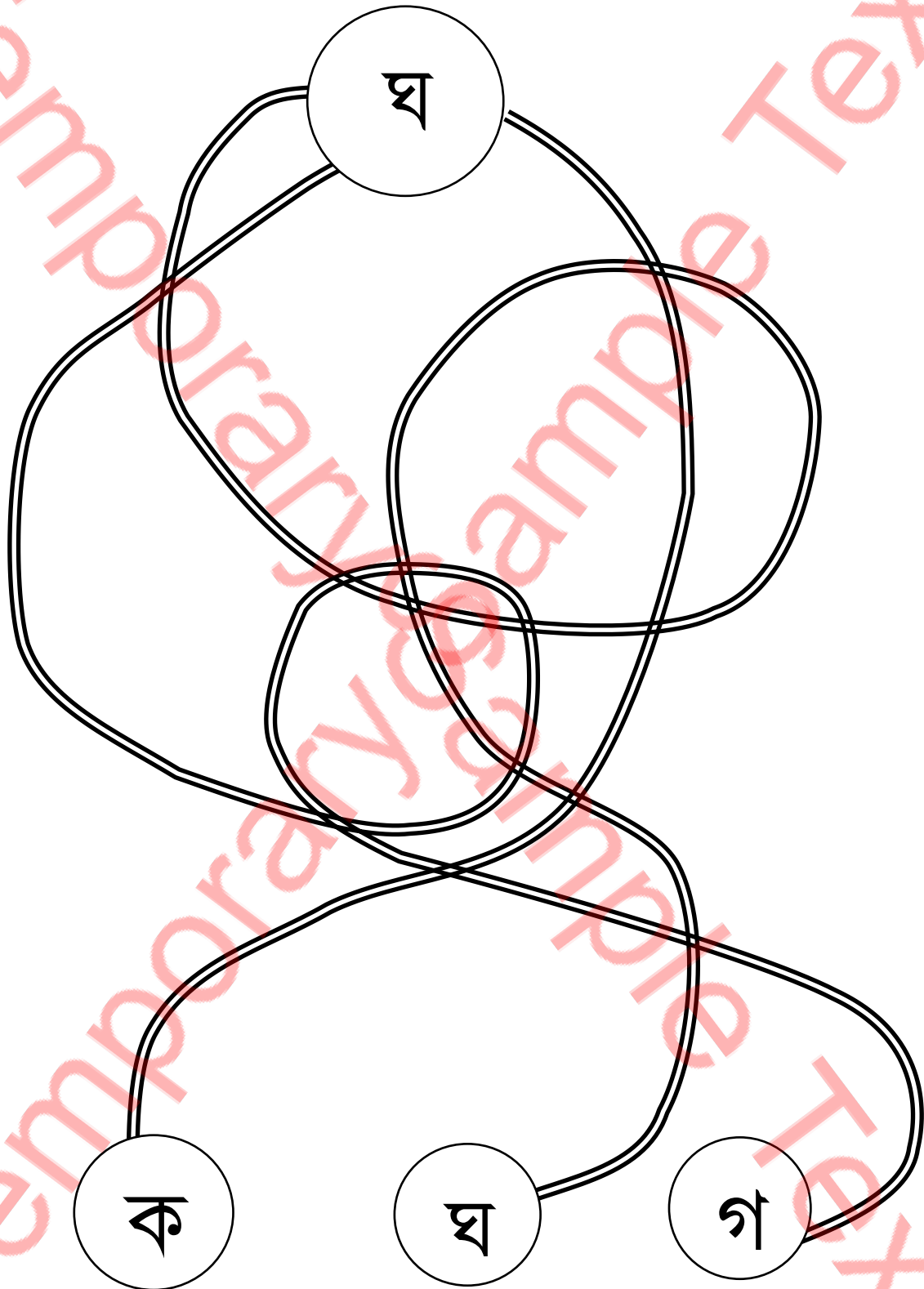

Student Name: _____

Verified By: _____

Class: _____

Date: _____

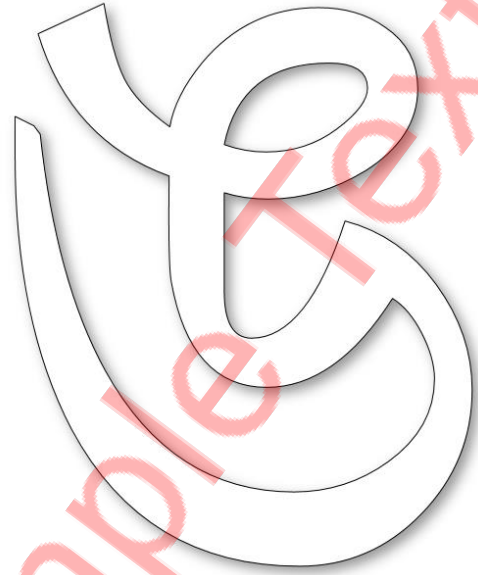
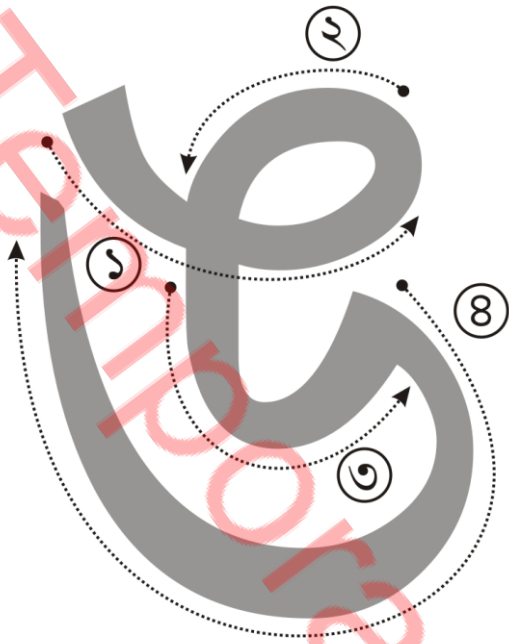

Follow the above steps

Colour it accordingly

ক	খ	গ	ঘ	ঙ	চ	ছ	জ
ঝ	ঞ	ট	ঠ	ড	ঢ	ণ	ত
থ	দ	ধ	ন	প	ফ	ব	ভ
ম	য	র	ল	শ	ষ	স	হ
ড়	ঢ়	য়	ৎ	ৎ	ঃ	ং	

Student Name: _____

Verified By: _____

Class: _____

Date: _____

Trace It



Student Name: _____

Verified By: _____

Class: _____

Date: _____

Trace it





Student Name: _____

Verified By: _____

Class: _____

Date: _____

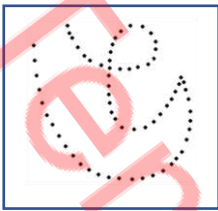
Write it

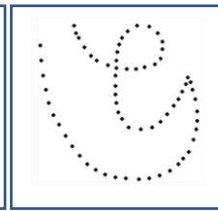
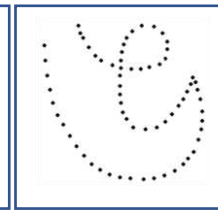
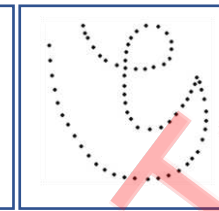
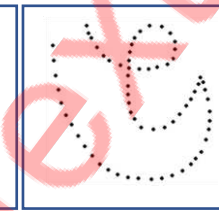
Student Name: _____

Verified By: _____

Class: _____

Date: _____

Copy Colour



Colour it



Write it

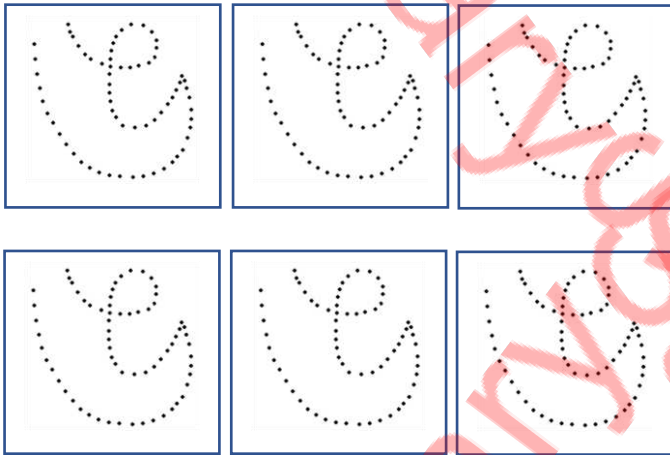

Find it

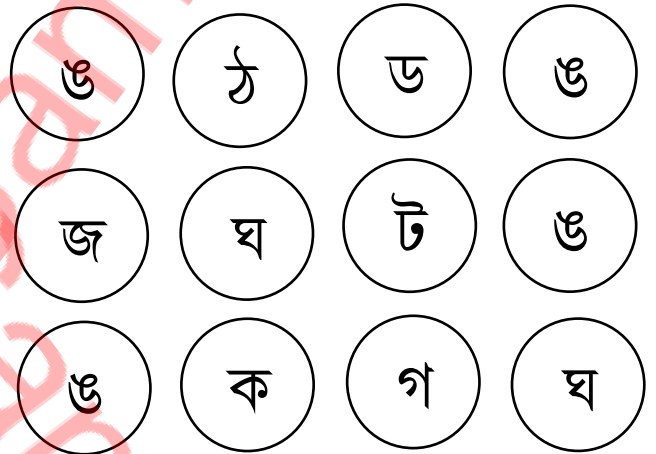

Connect the circle

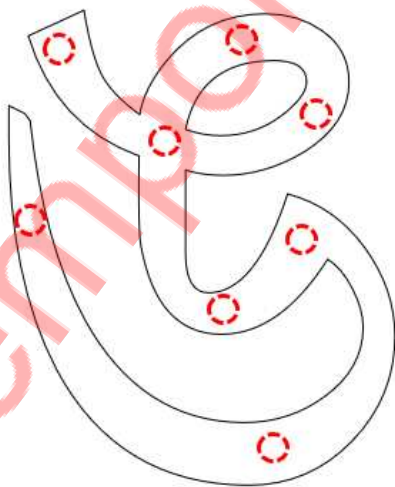

Do it

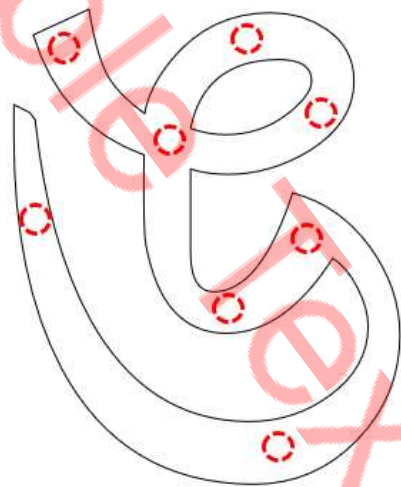

Student Name: _____

Verified By: _____

Class: _____

Date: _____

Pick the Path Find the Correct Alphabet

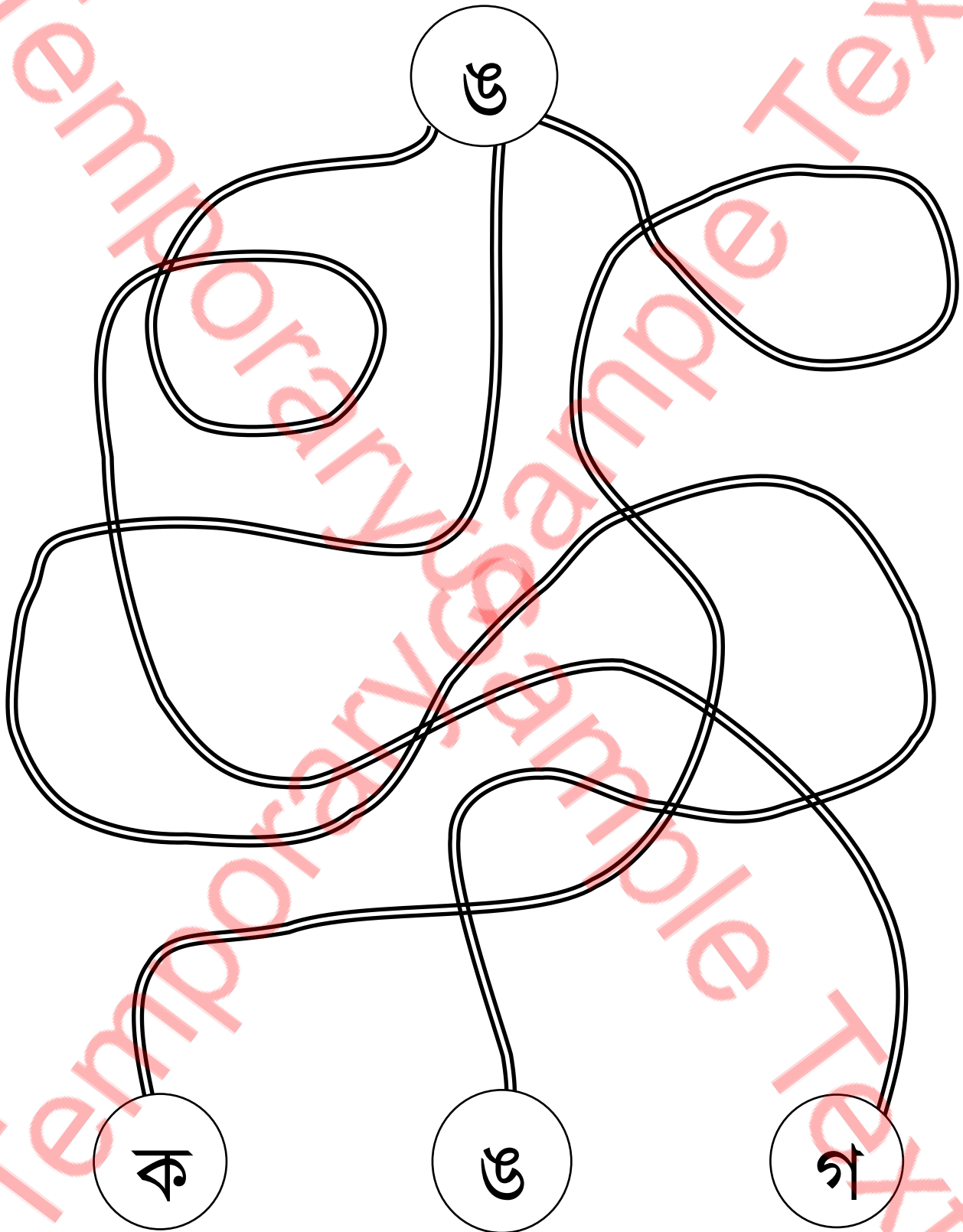

Student Name: _____

Verified By: _____

Class: _____

Date: _____

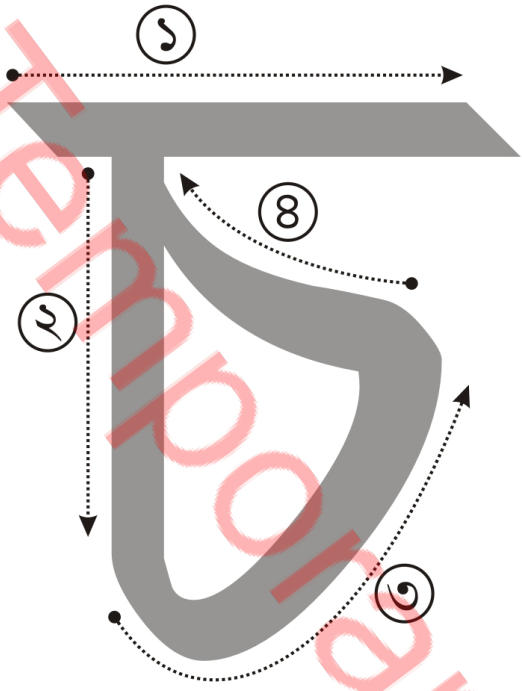

Follow the above steps



Colour it accordingly

ক	খ	গ	ঘ	ঙ	চ	ছ	জ
ঝ	ঞ	ট	ঠ	ড	ঢ	ণ	ত
থ	দ	ধ	ন	প	ফ	ব	ভ
ম	য	র	ল	শ	ষ	স	হ
ড়	ঢ়	য়	ৎ	ৎ	ঃ	ঃ	

Student Name: _____

Verified By: _____

Class: _____

Date: _____

Trace It



Student Name: _____

Verified By: _____

Class: _____

Date: _____

Trace it



Student Name: _____

Verified By: _____

Class: _____

Date: _____

Write it

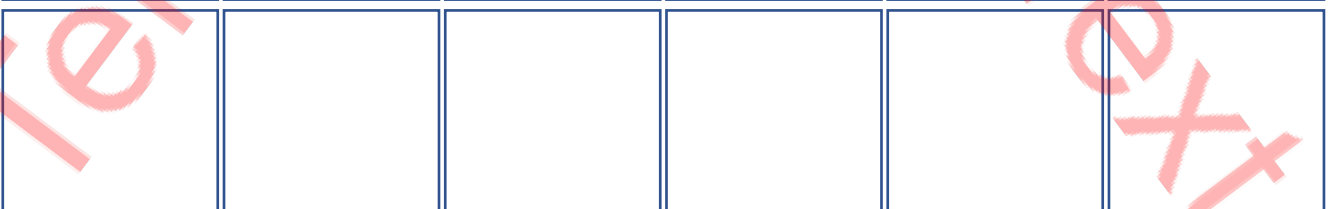
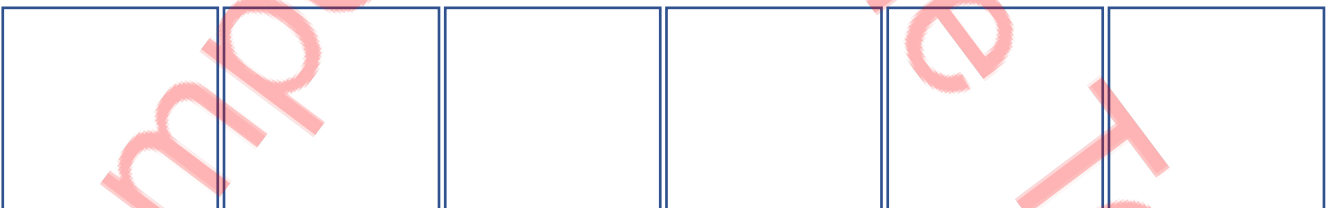
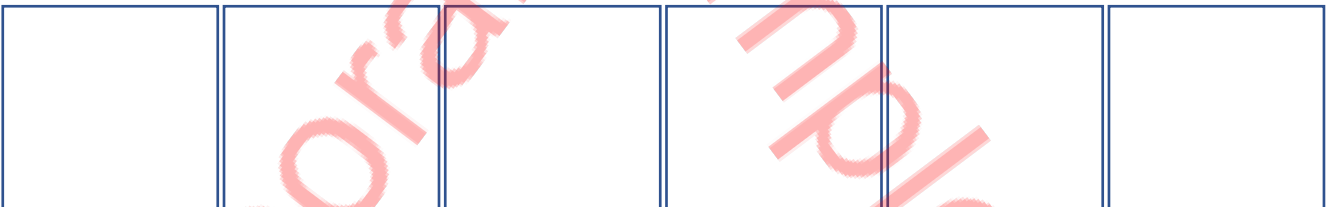
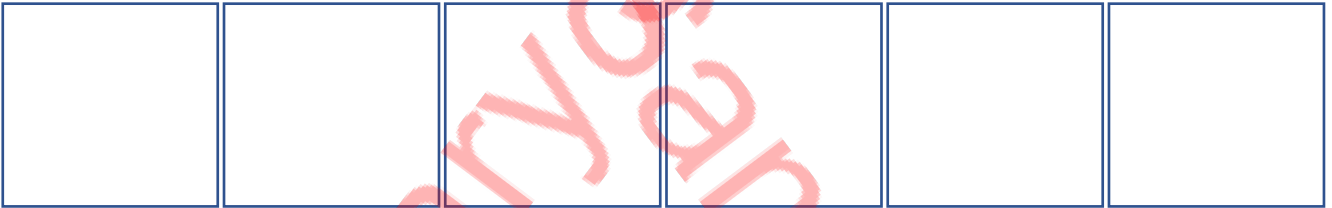
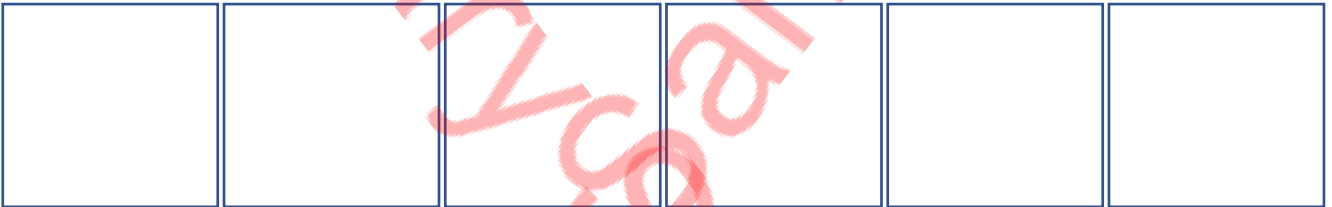
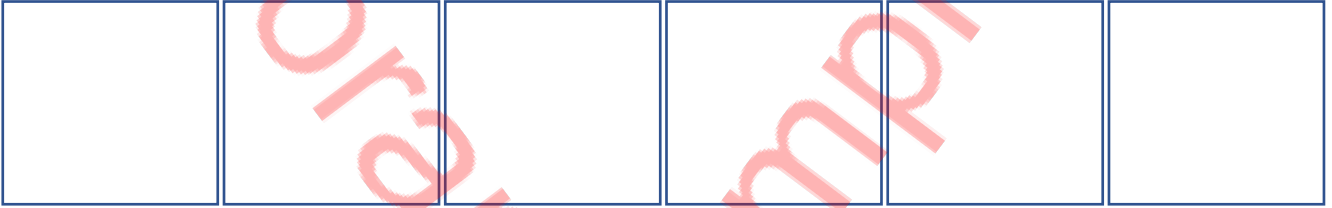
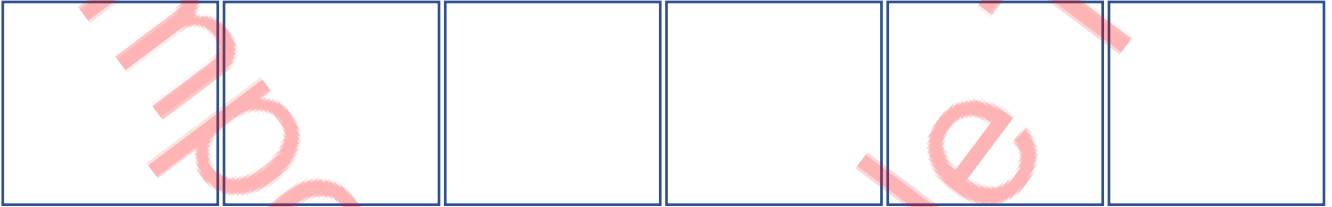
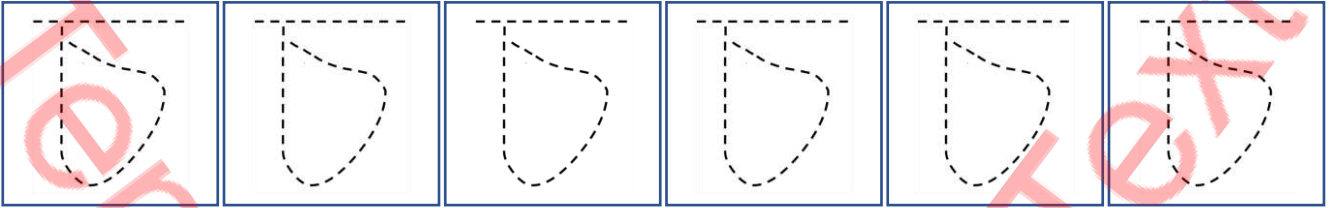

Student Name: _____

Verified By: _____

Class: _____

Date: _____

Copy Colour

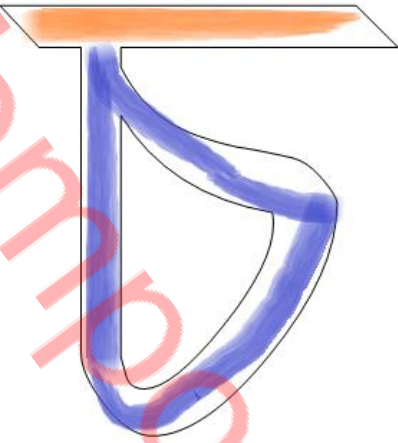

Colour it

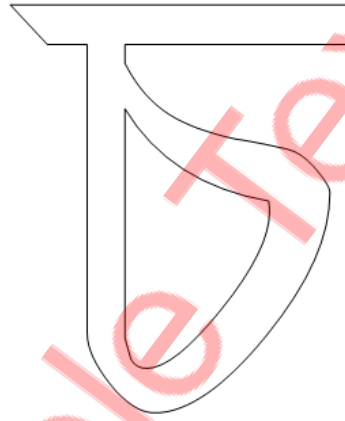

Write it

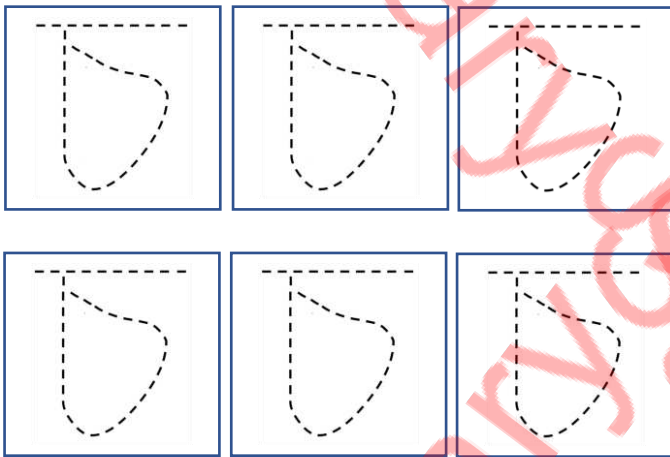

Find it

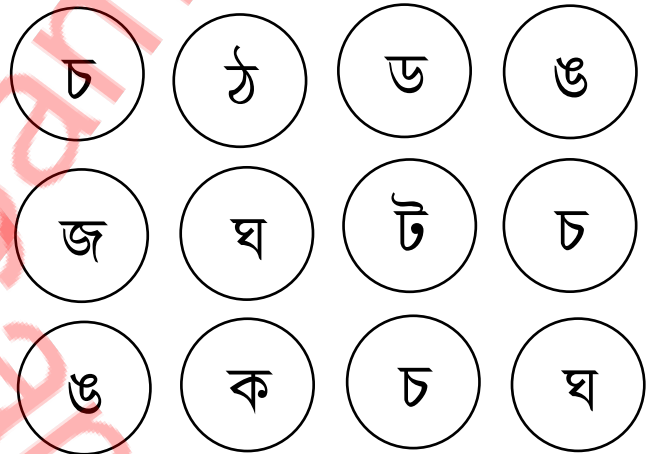

Connect the circle

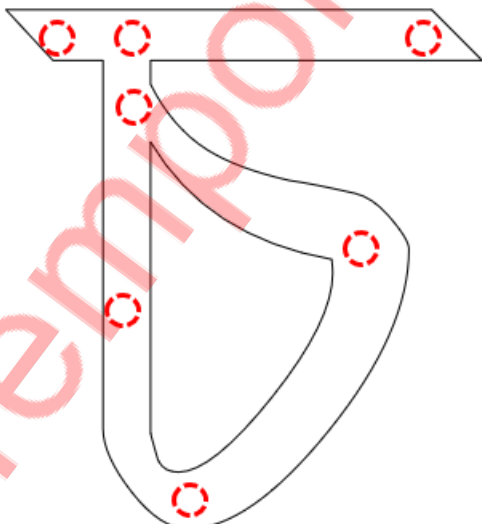

Do it

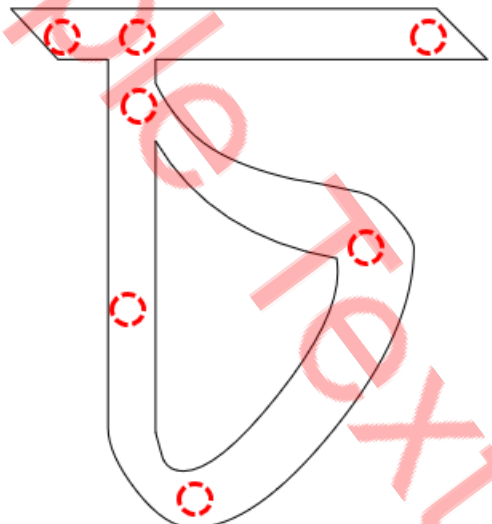

Student Name: _____

Verified By: _____

Class: _____

Date: _____

Pick the Path Find the Correct Alphabet

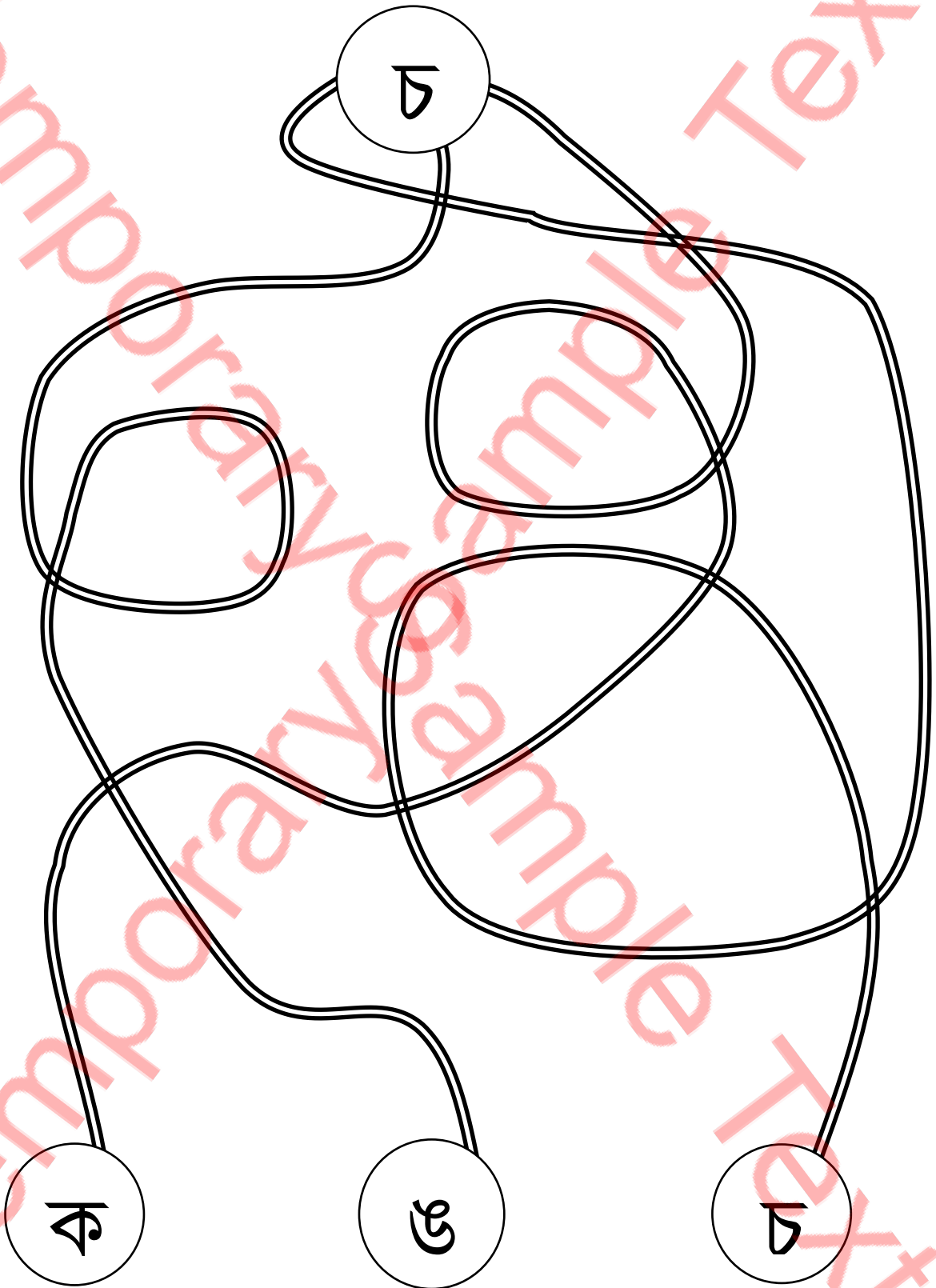

Student Name: _____

Verified By: _____

Class: _____

Date: _____

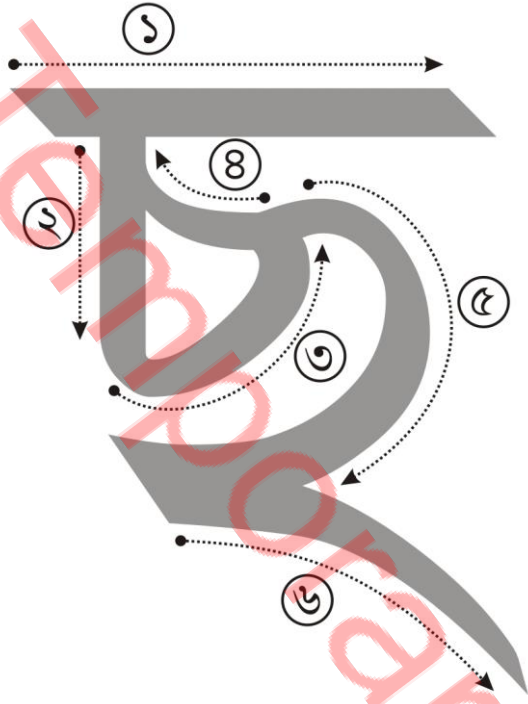

Follow the above steps



Colour it accordingly

ক	খ	গ	ঘ	ঙ	চ	ছ	জ
ঝ	ঞ	ট	ঠ	ড	ঢ	ণ	ত
থ	দ	ধ	ন	প	ফ	ব	ভ
ম	য	র	ল	শ	ষ	স	হ
ড়	ঢ়	য়	ৌ	্	ৎ	৏	

Student Name: _____

Verified By: _____

Class: _____

Date: _____

Trace It



Student Name: _____

Verified By: _____

Class: _____

Date: _____

Trace it



Student Name: _____

Verified By: _____

Class: _____

Date: _____

Write it

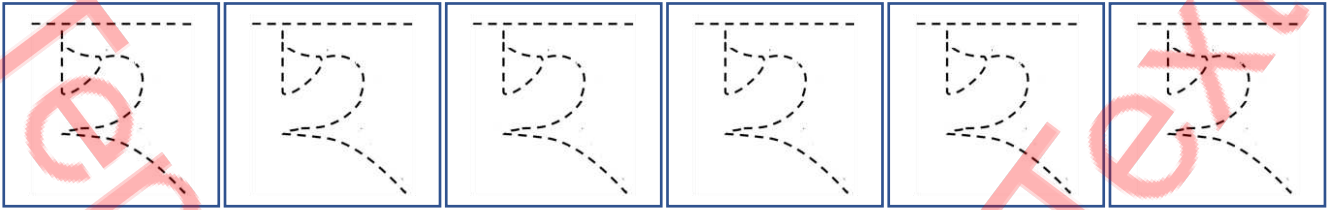

Student Name: _____

Verified By: _____

Class: _____

Date: _____

Copy Colour



Colour it

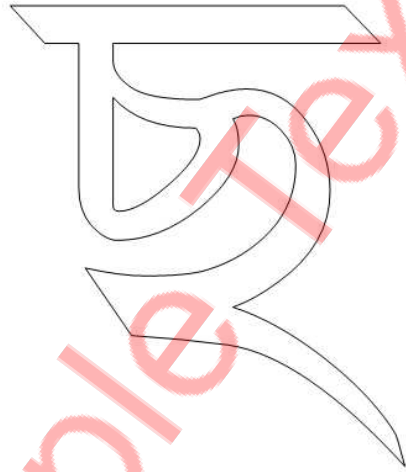

Write it

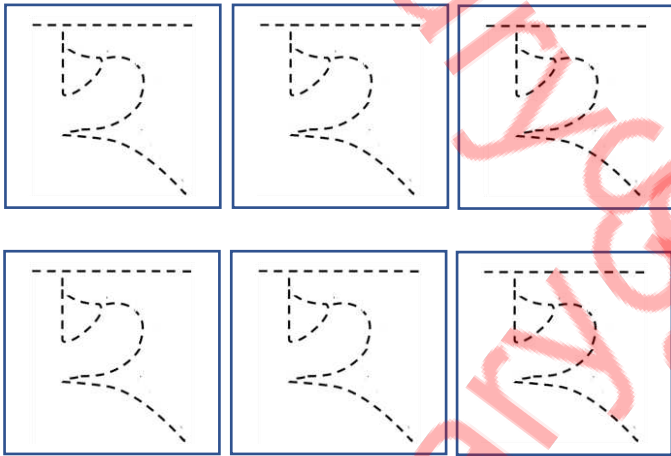

Find it

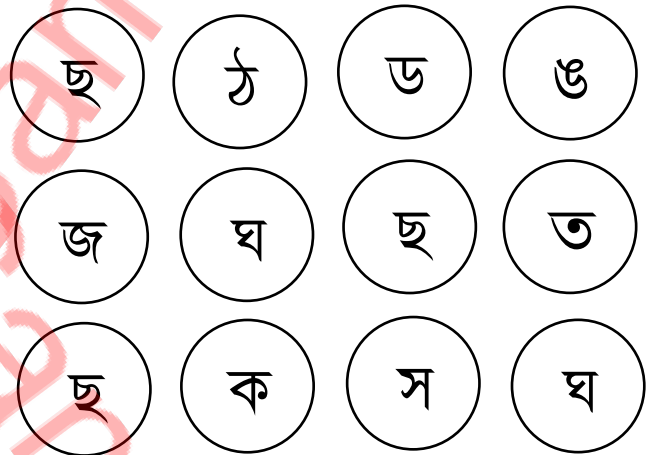

Connect the circle

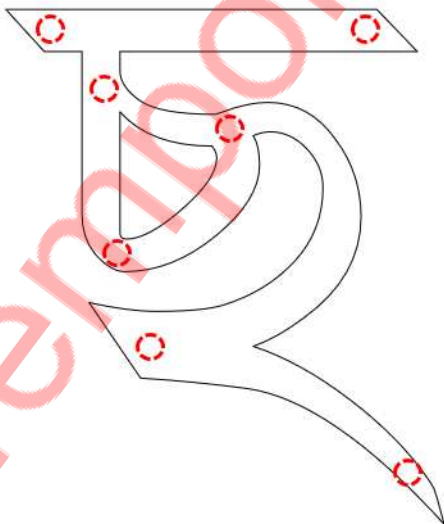

Do it

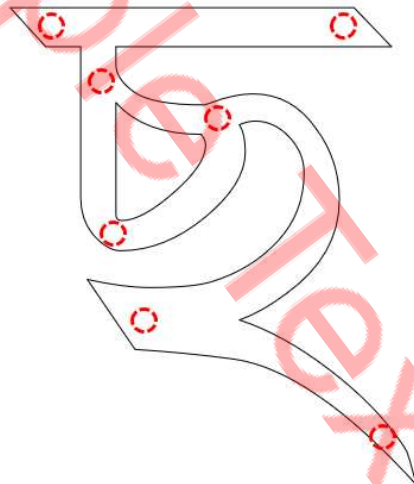

Student Name: _____

Verified By: _____

Class: _____

Date: _____

Pick the Path Find the Correct Alphabet

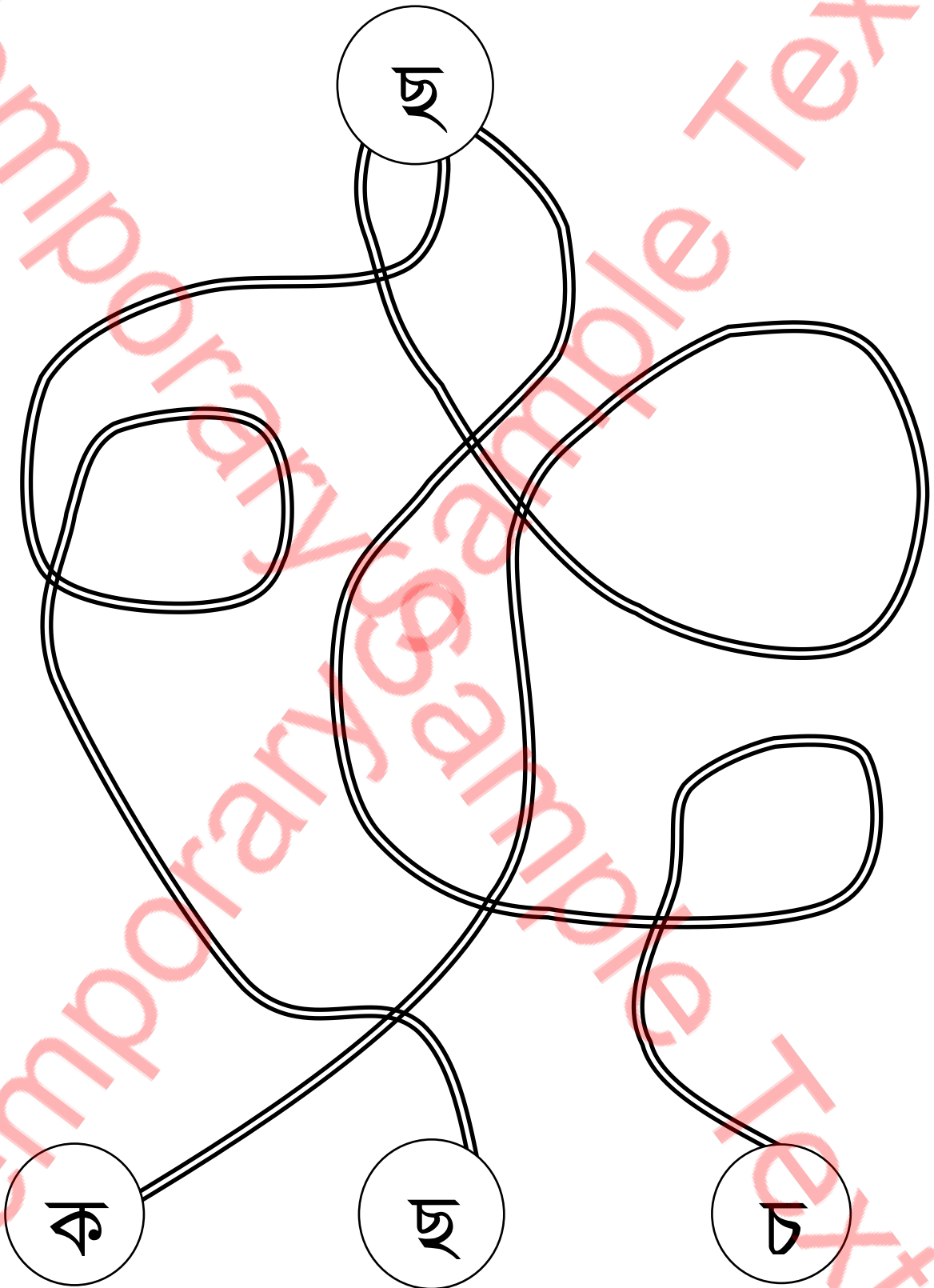

Student Name: _____

Verified By: _____

Class: _____

Date: _____

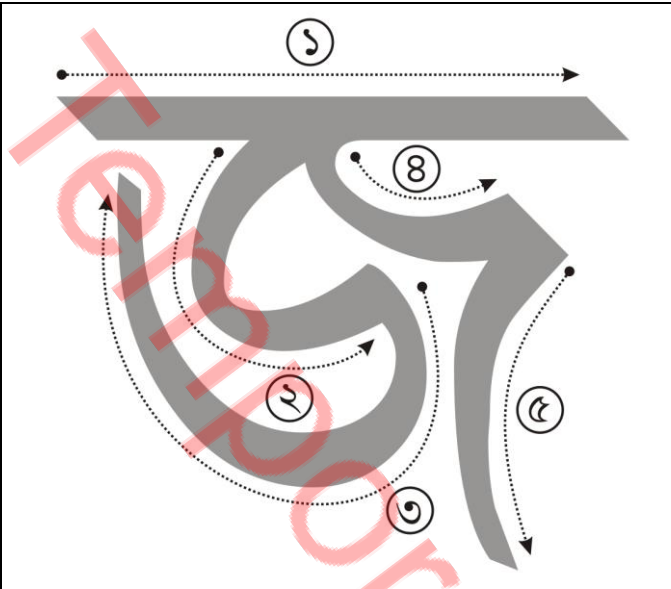

Follow the above steps

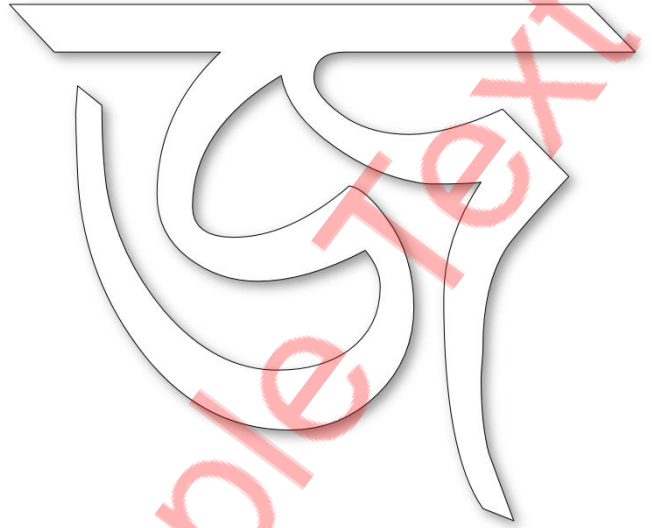

Colour it accordingly

ক	খ	গ	ঘ	ঙ	চ	ছ	জ
ঝ	ঞ	ট	ঠ	ড	ঢ	ণ	ত
থ	দ	ধ	ন	প	ফ	ব	ভ
ম	য	র	ল	শ	ষ	স	হ
ড়	ঢ়	য়	ৱ	৲	৳	৴	

Student Name: _____

Verified By: _____

Class: _____

Date: _____

Trace It

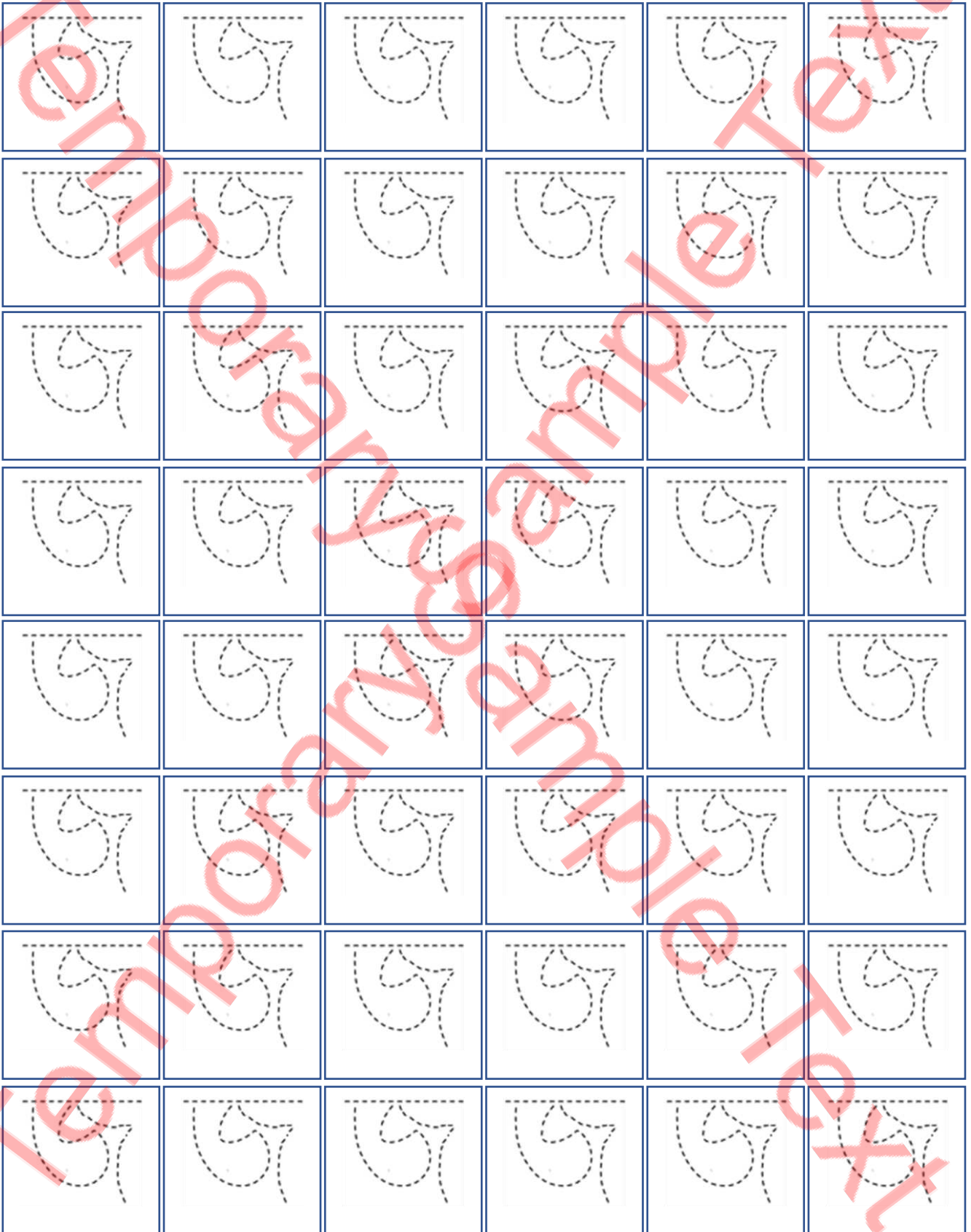

Student Name: _____

Verified By: _____

Class: _____

Date: _____

Trace it

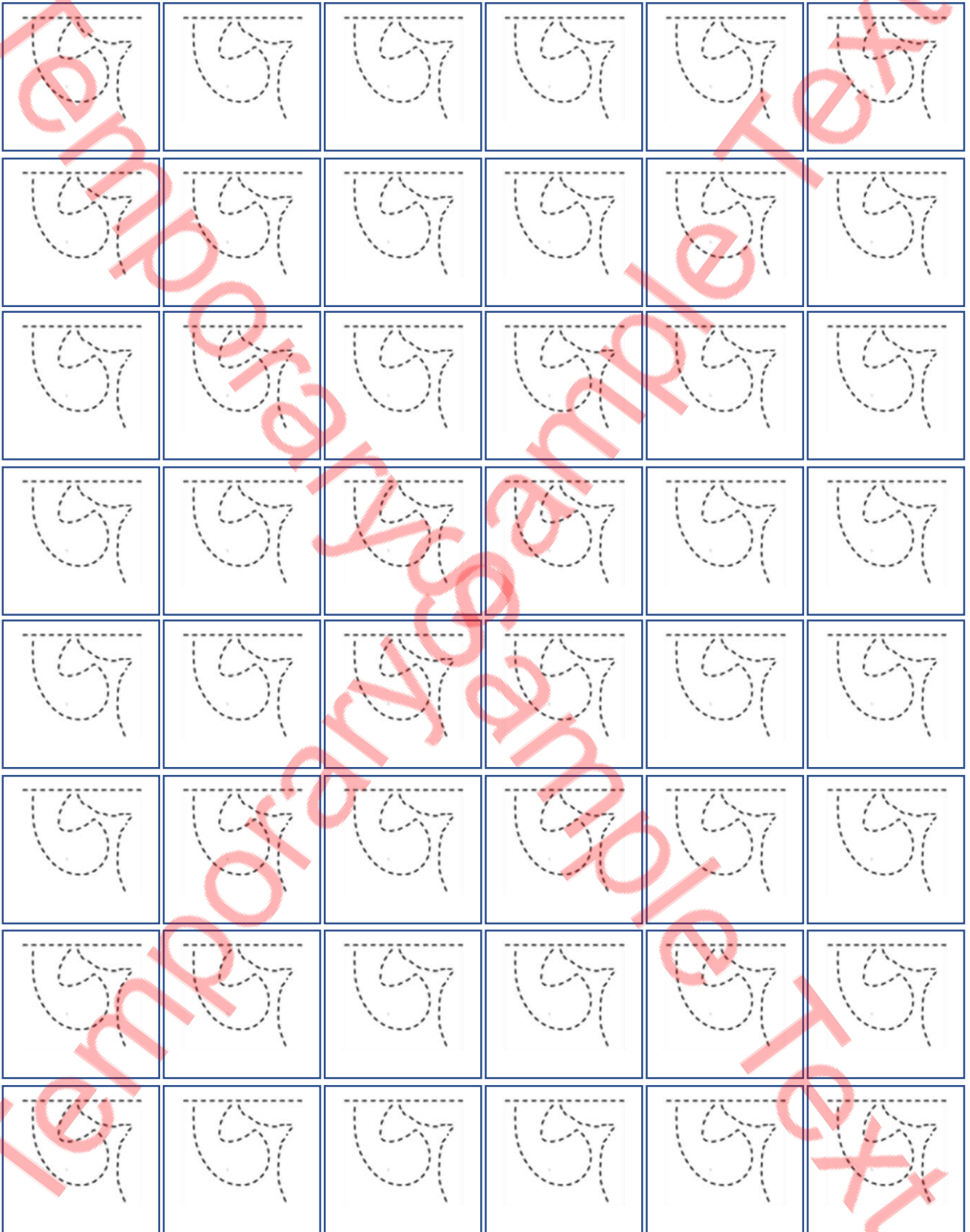

Student Name: _____

Verified By: _____

Class: _____

Date: _____

Write it

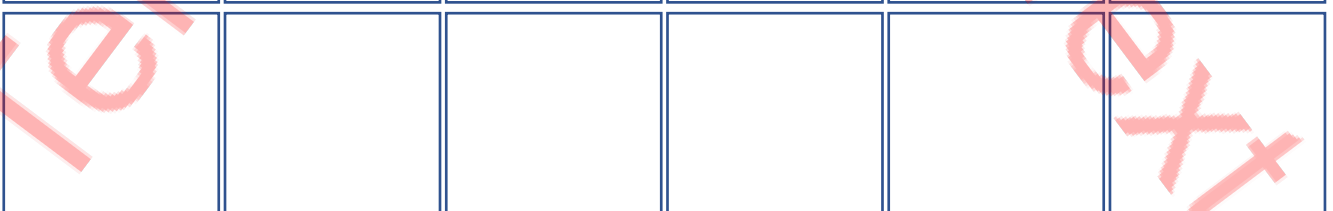
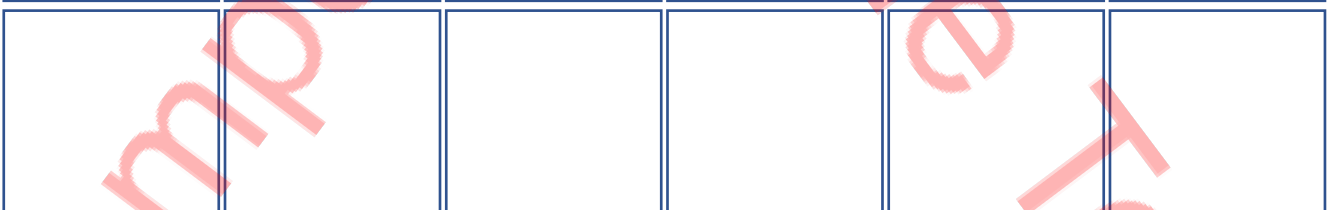
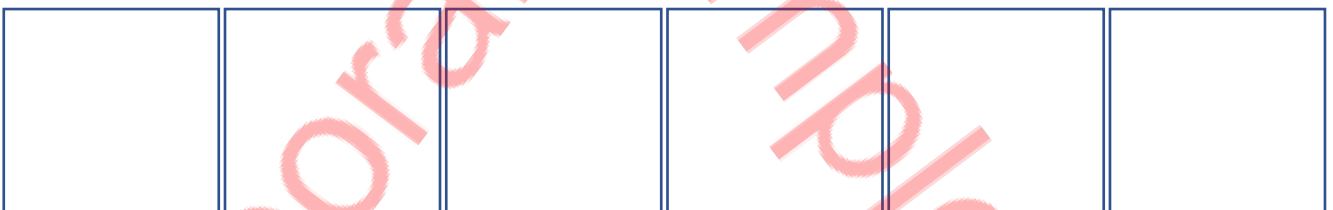
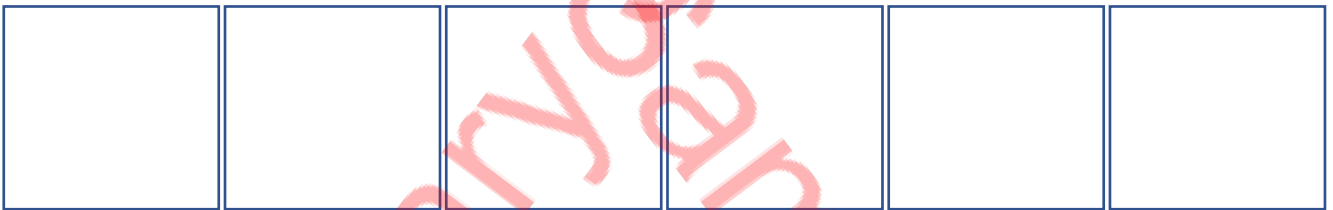
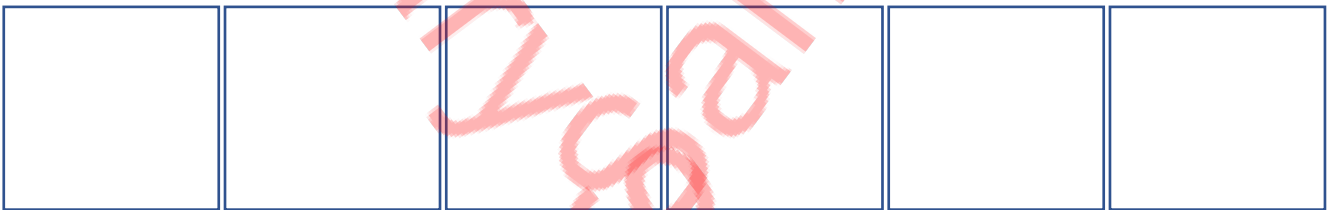
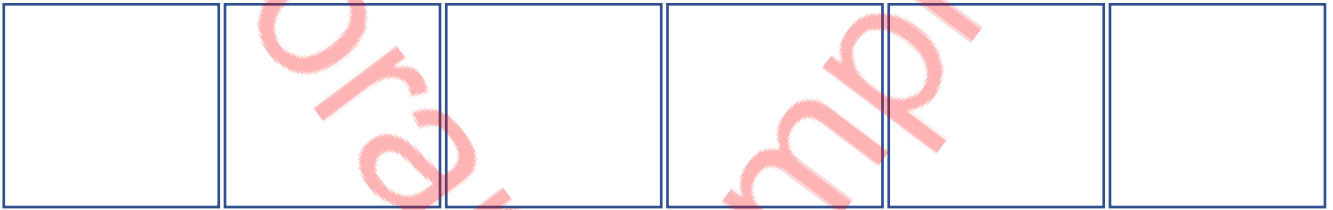
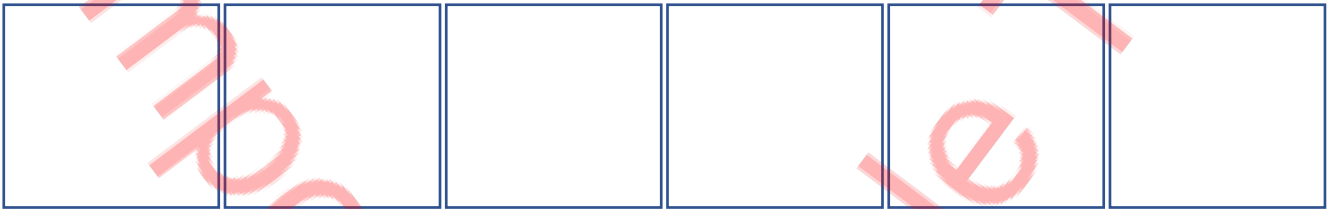
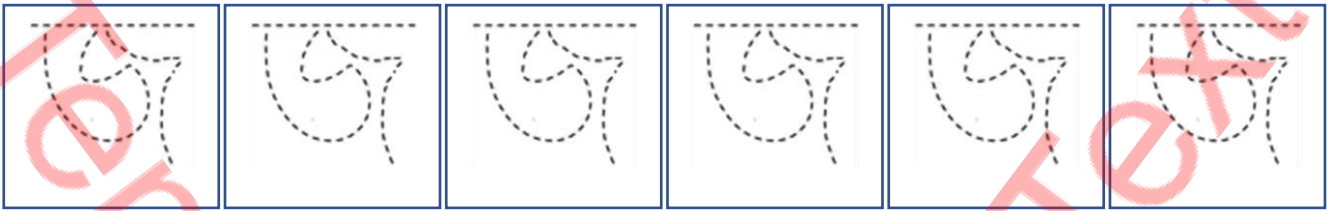

Student Name: _____

Verified By: _____

Class: _____

Date: _____

Copy Colour

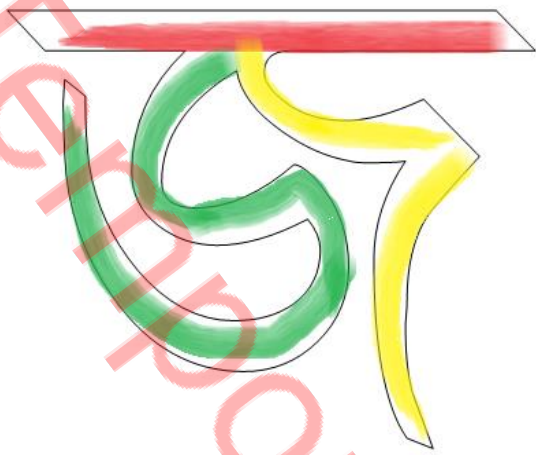

Colour it

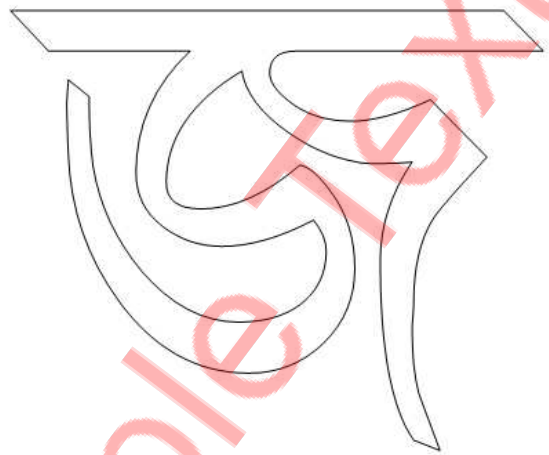

Write it

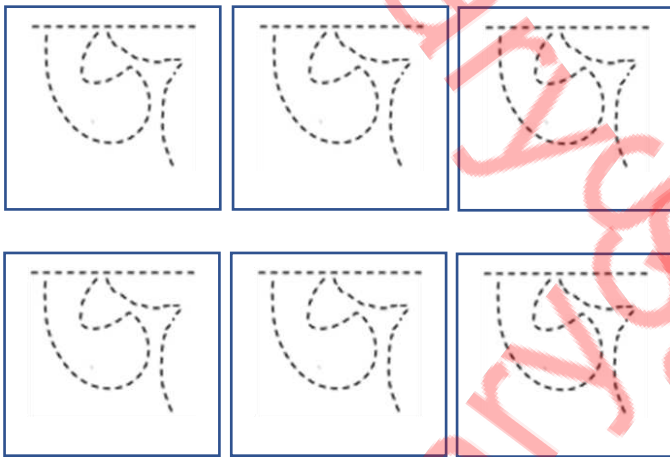

Find it



Connect the circle

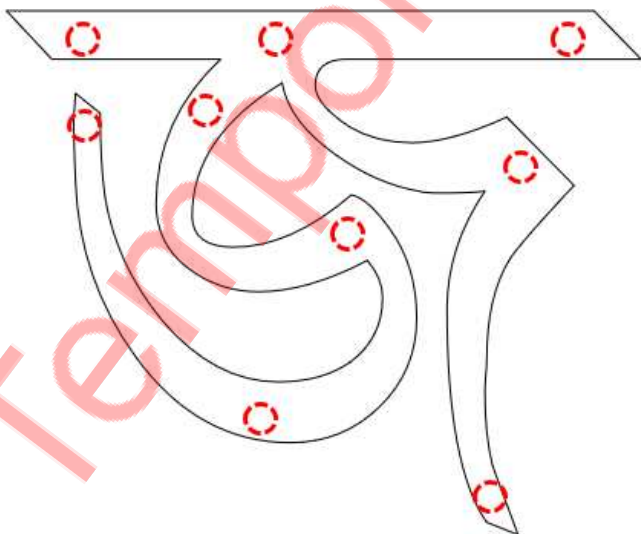

Do it

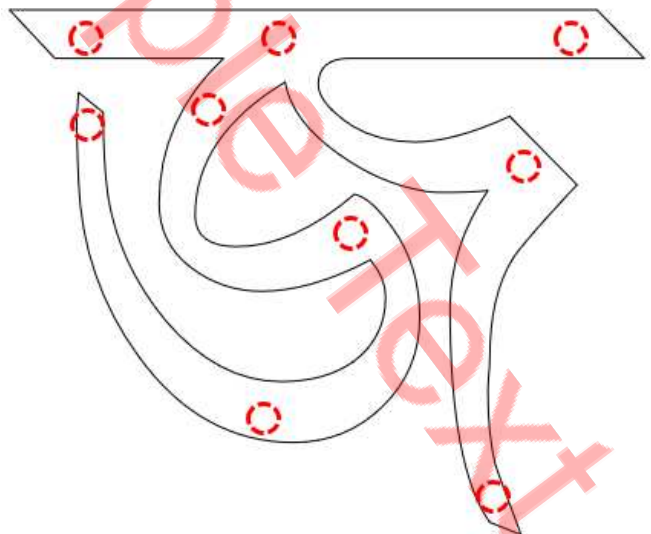

Student Name: _____

Verified By: _____

Class: _____

Date: _____

Pick the Path Find the Correct Alphabet

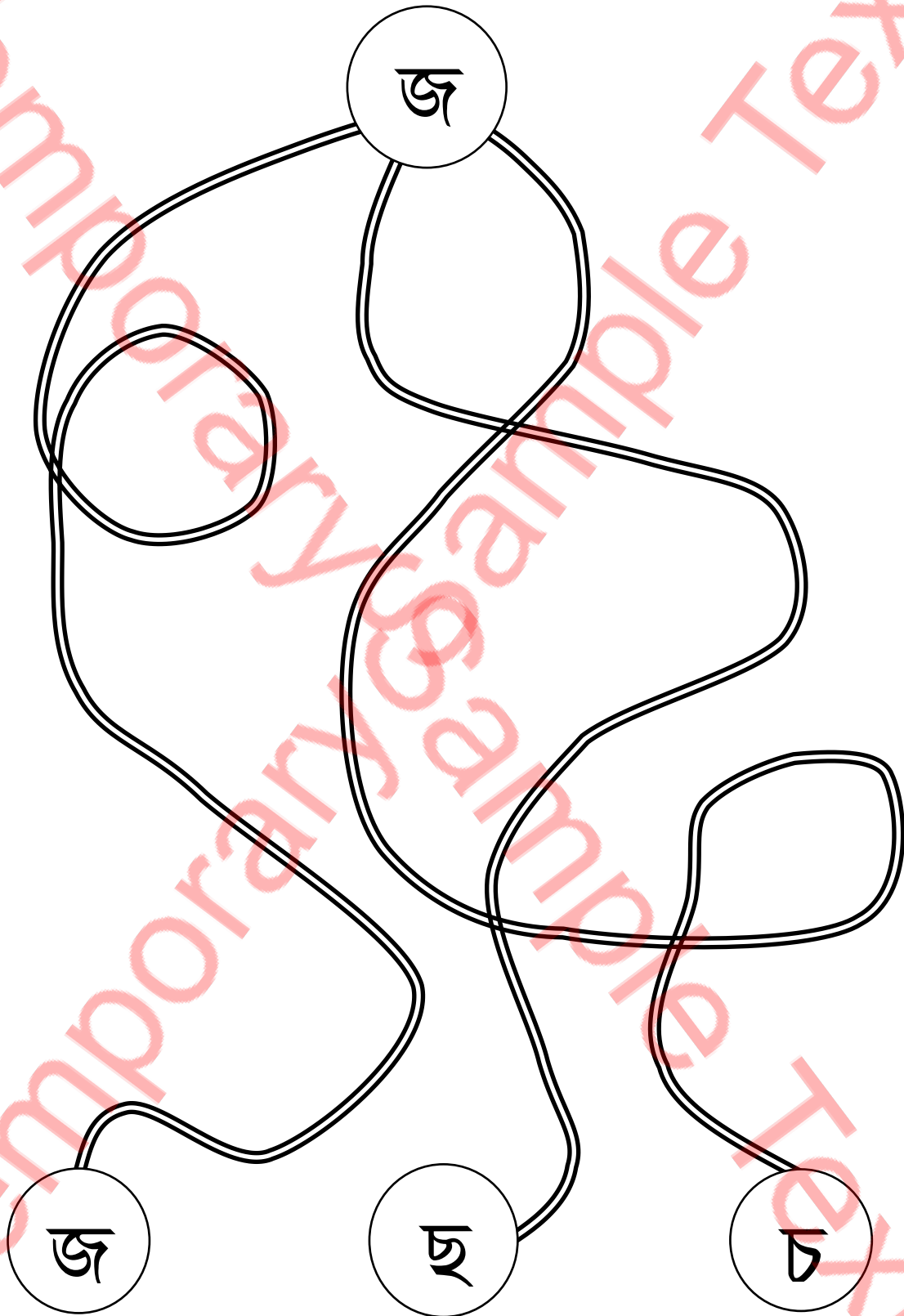

Student Name: _____

Verified By: _____

Class: _____

Date: _____

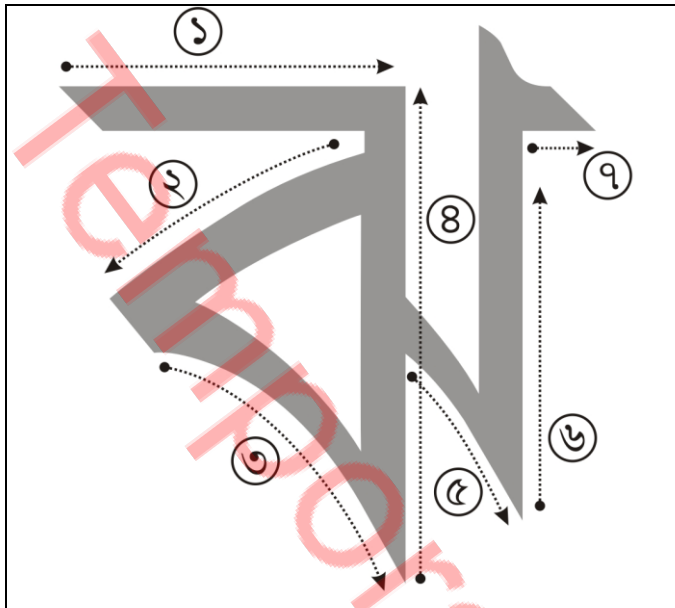

Follow the above steps

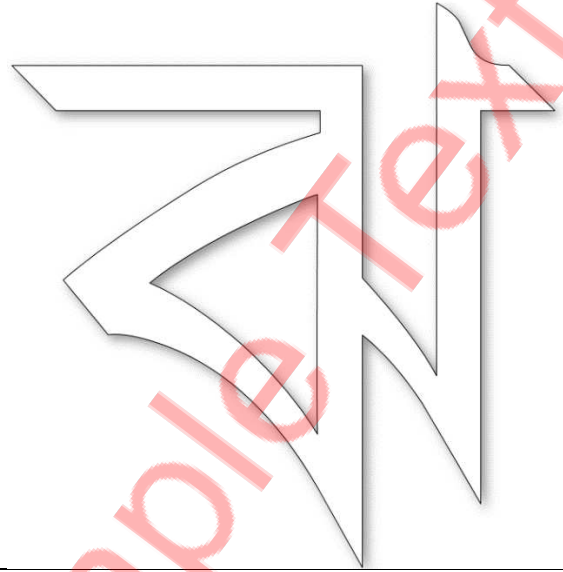

Colour it accordingly

ক	খ	গ	ঘ	ঙ	চ	ছ	জ
ষ	ঞ	ট	ঠ	ড	ঢ	ণ	ত
থ	দ	ধ	ন	প	ফ	ব	ভ
ম	য	র	ল	শ	ষ	স	হ
ড়	ঢ়	য়	ৱ	৲	৳	৴	

Student Name: _____

Verified By: _____

Class: _____

Date: _____

Trace It

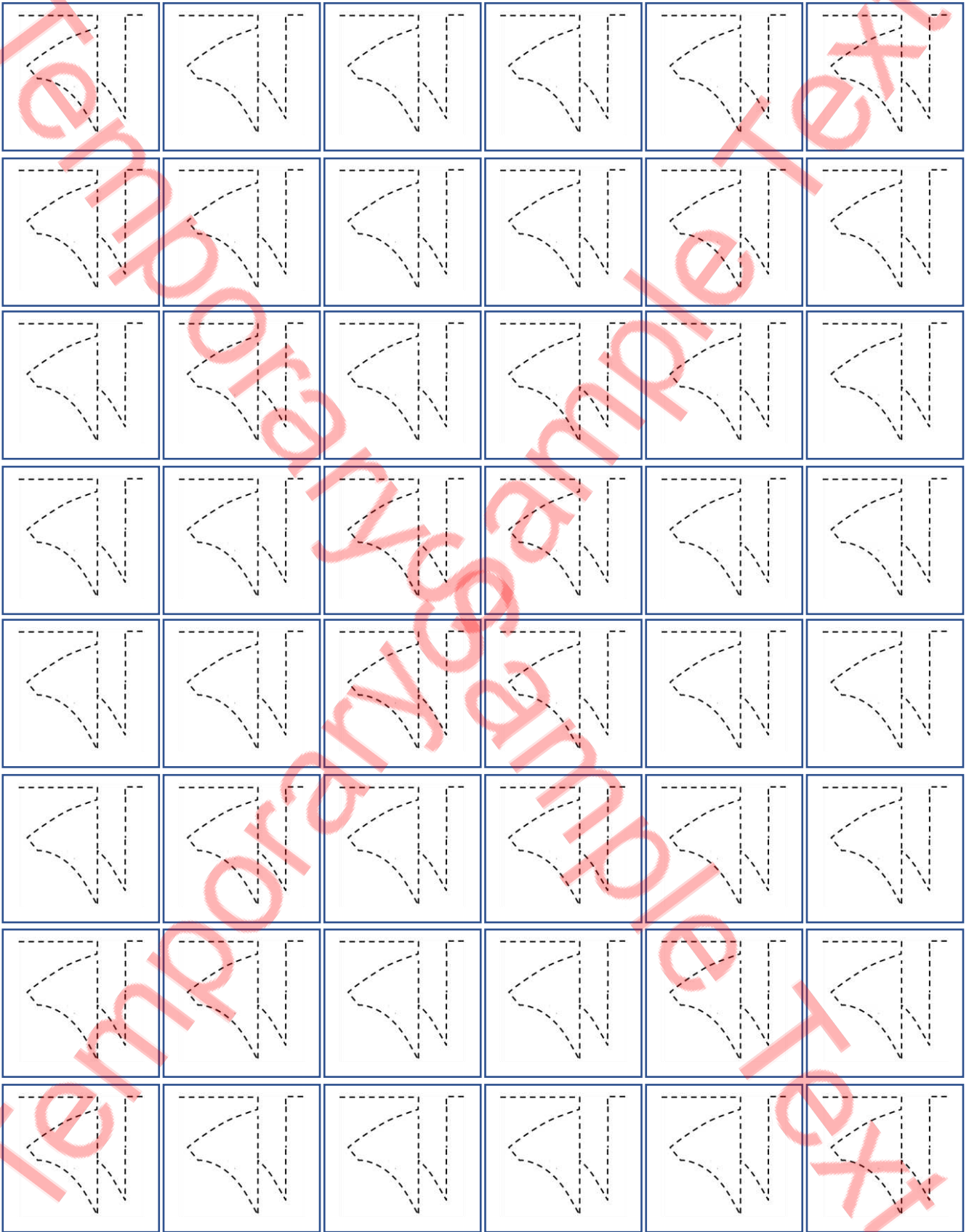

Student Name: _____

Verified By: _____

Class: _____

Date: _____

Trace it

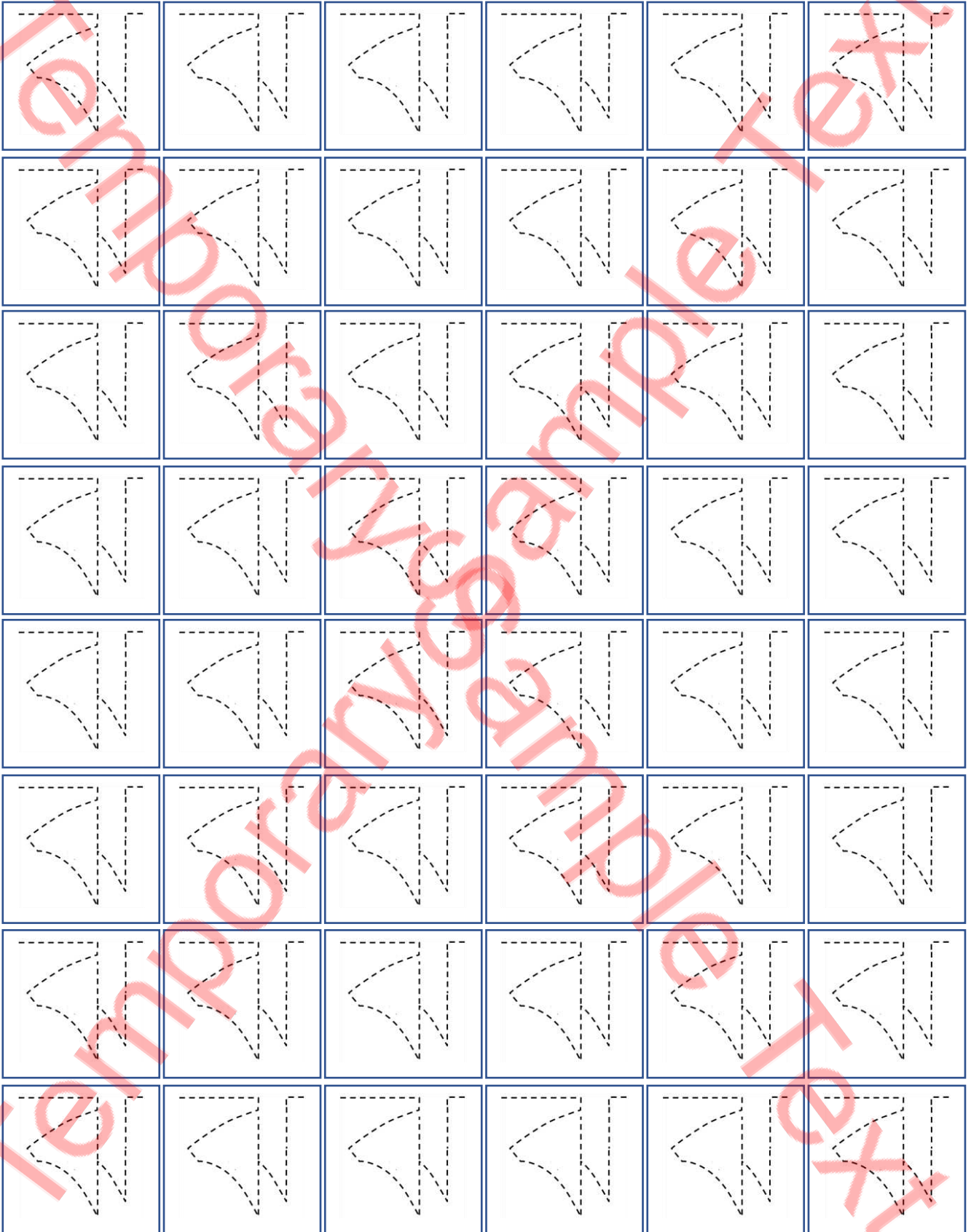

Student Name: _____

Verified By: _____

Class: _____

Date: _____

Write it

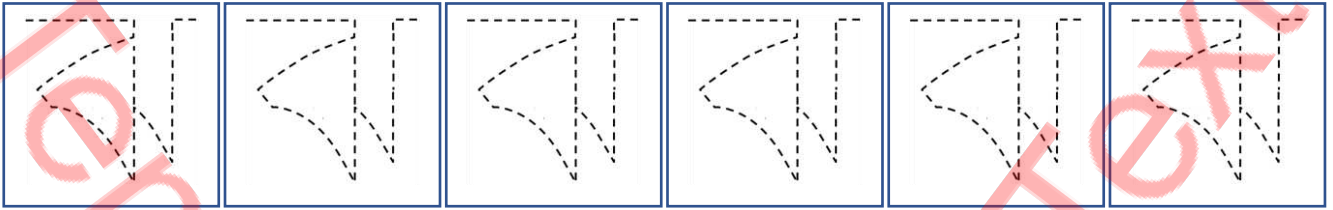

Student Name: _____

Verified By: _____

Class: _____

Date: _____

Copy Colour

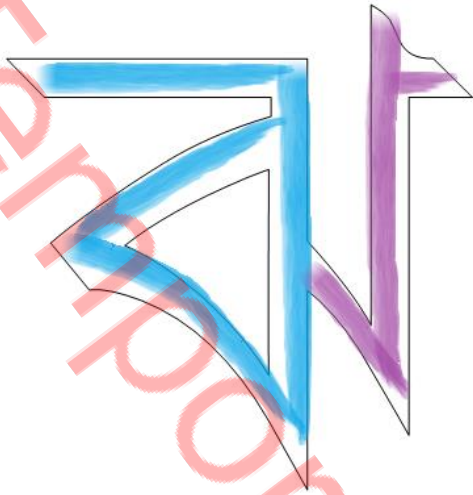

Colour it

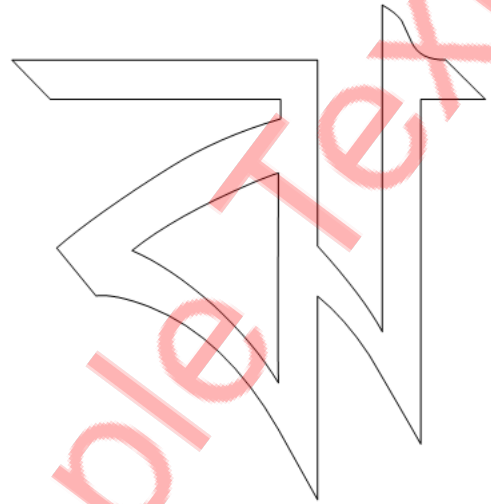

Write it

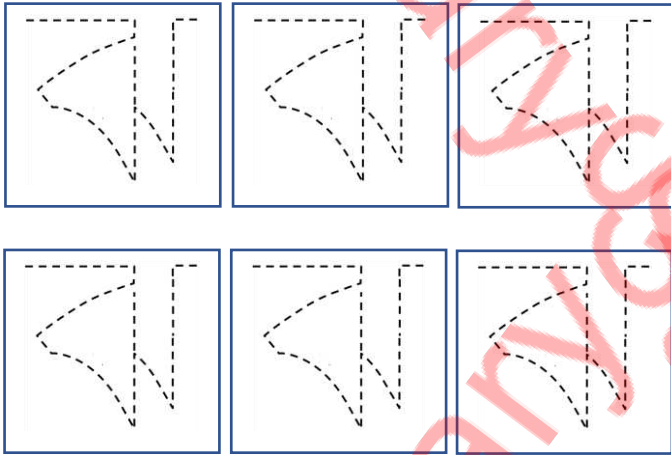

Find it



Connect the circle

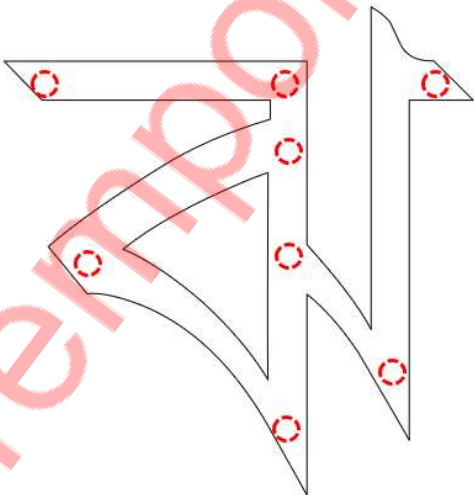

Do it

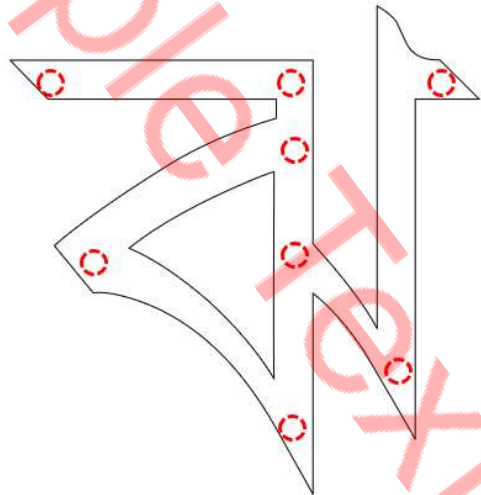

Student Name: _____

Verified By: _____

Class: _____

Date: _____

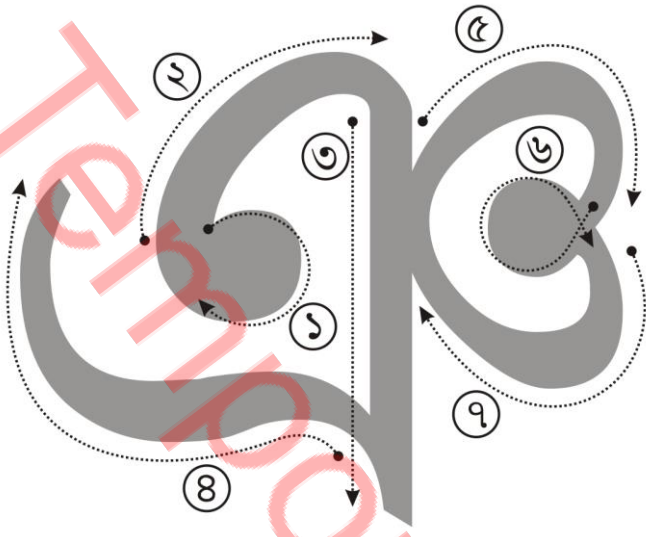

Follow the above steps



Colour it accordingly

ক	খ	গ	ঘ	ঙ	চ	ছ	জ
ঝ	ঞ	ট	ঠ	ড	ঢ	ণ	ত
থ	দ	ধ	ন	প	ফ	ব	ভ
ম	য	র	ল	শ	ষ	স	হ
ড়	ঢ়	য়	ৗ	ৠ	ৡ	ৢ	

Student Name: _____

Verified By: _____

Class: _____

Date: _____

Trace It



Student Name: _____

Verified By: _____

Class: _____

Date: _____

Trace it

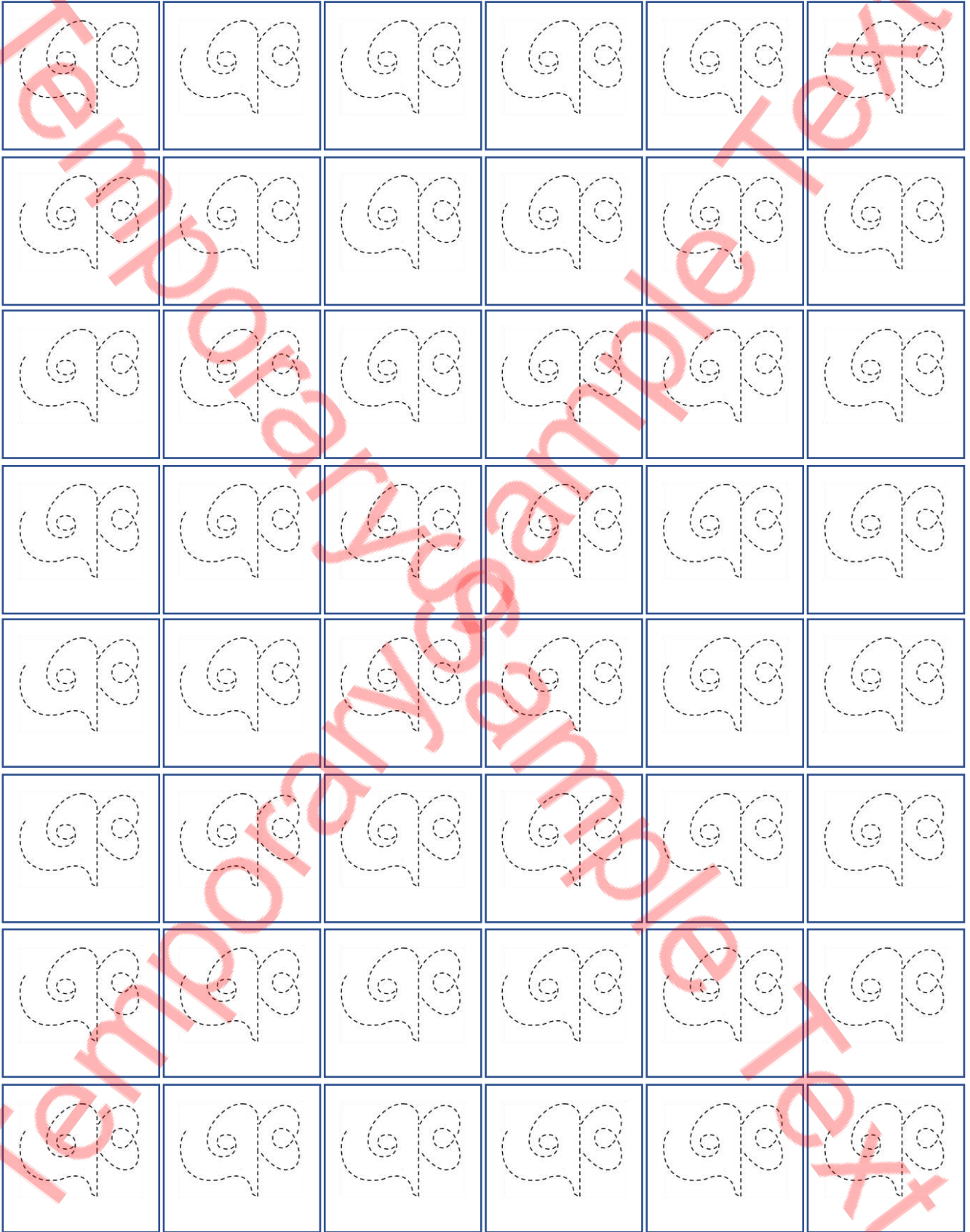

Student Name: _____

Verified By: _____

Class: _____

Date: _____

Write it

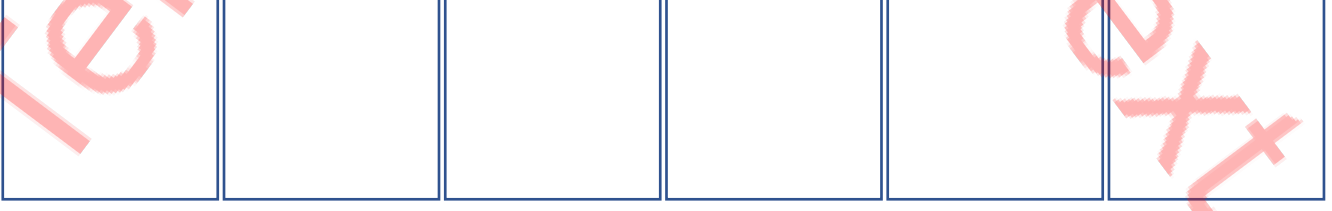
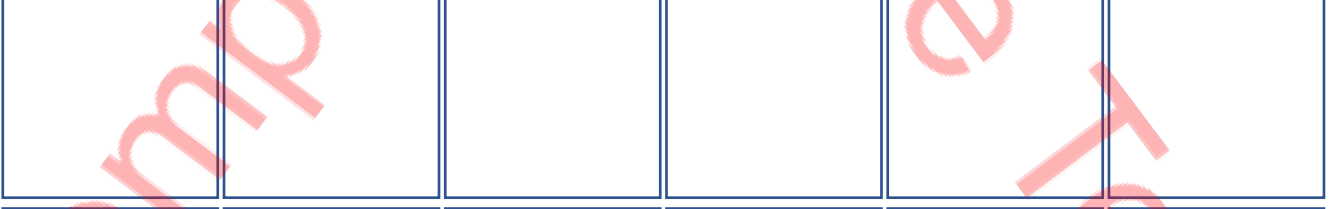
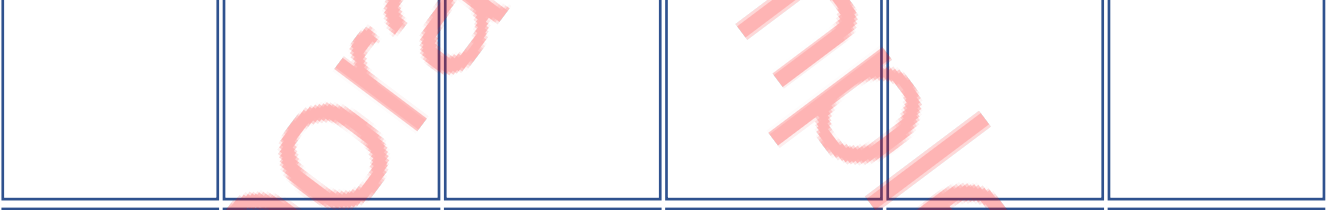
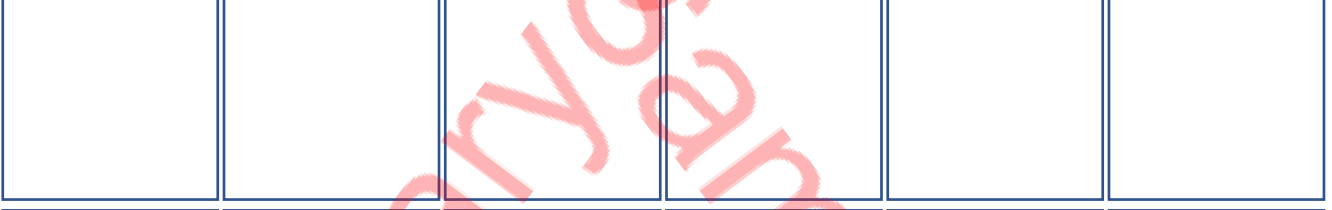
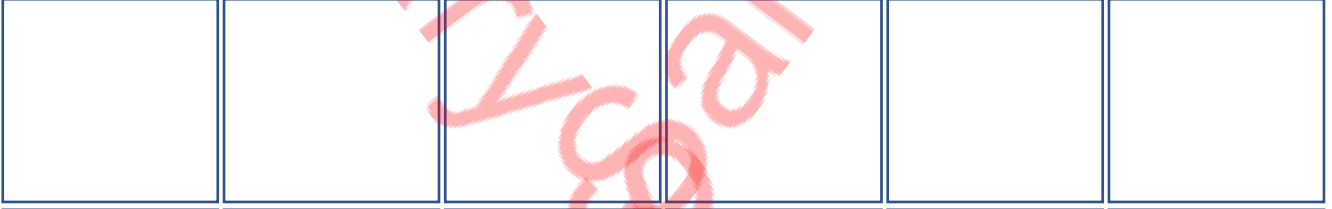
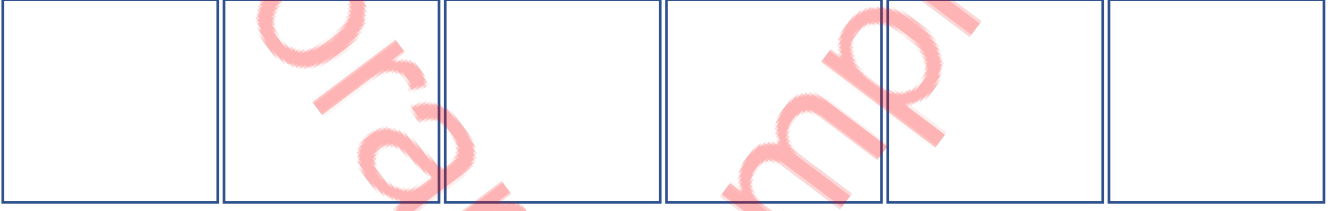
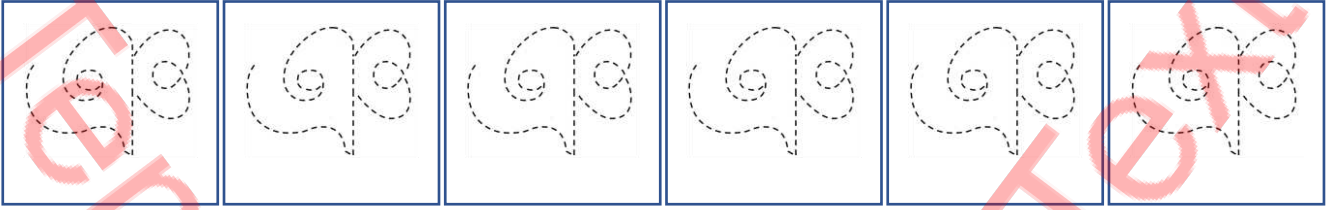

Student Name: _____

Verified By: _____

Class: _____

Date: _____

Copy Colour

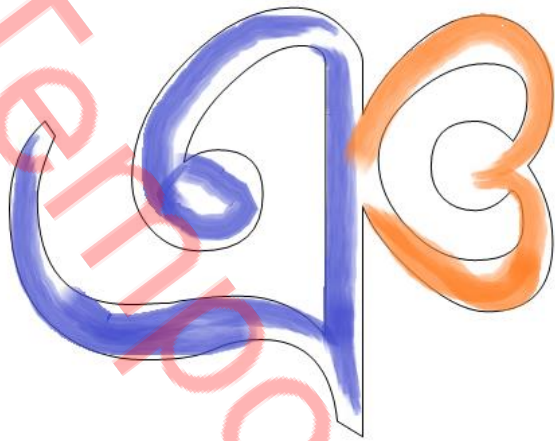

Colour it



Write it

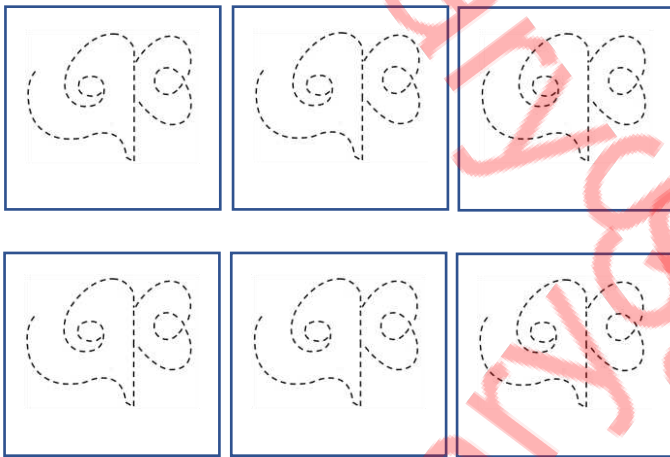

Find it



Connect the circle

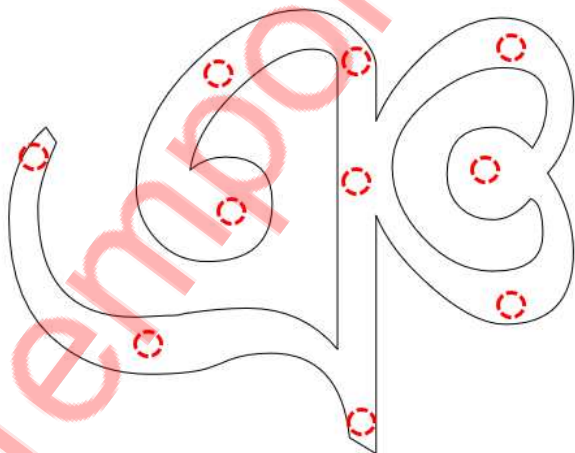

Do it

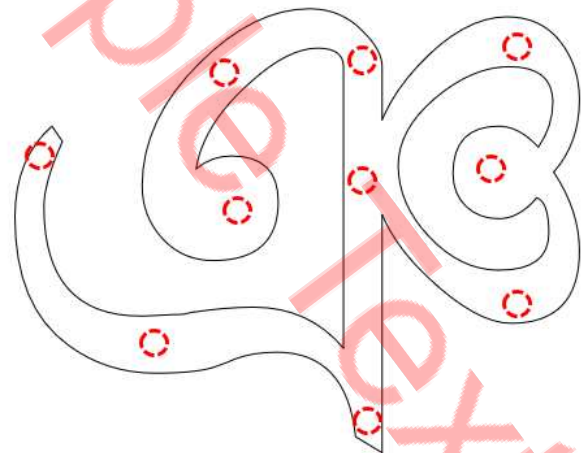

Student Name: _____

Verified By: _____

Class: _____

Date: _____

Pick the Path Find the Correct Alphabet

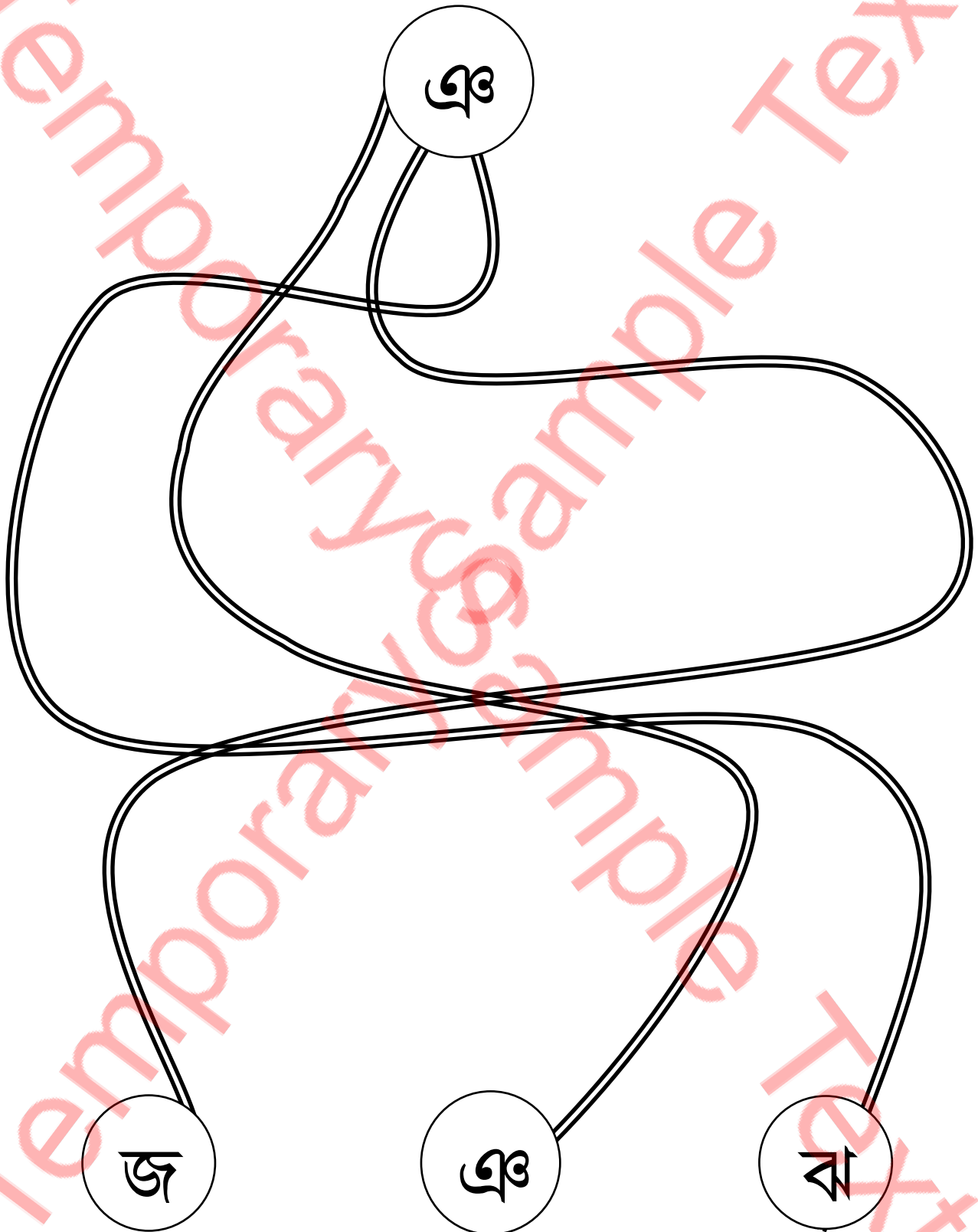

Student Name: _____

Verified By: _____

Class: _____

Date: _____

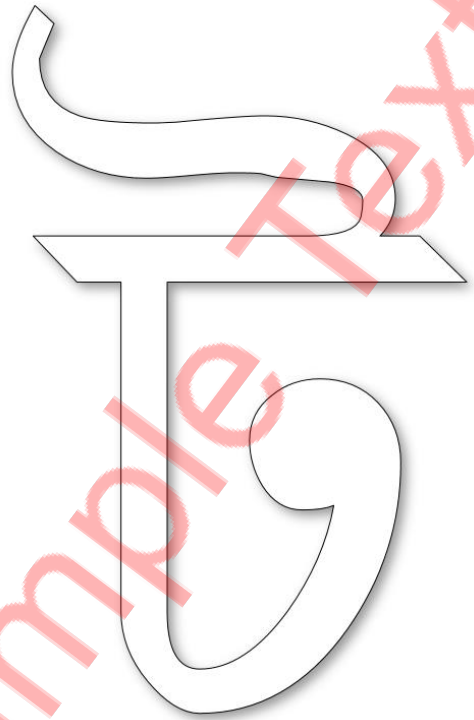
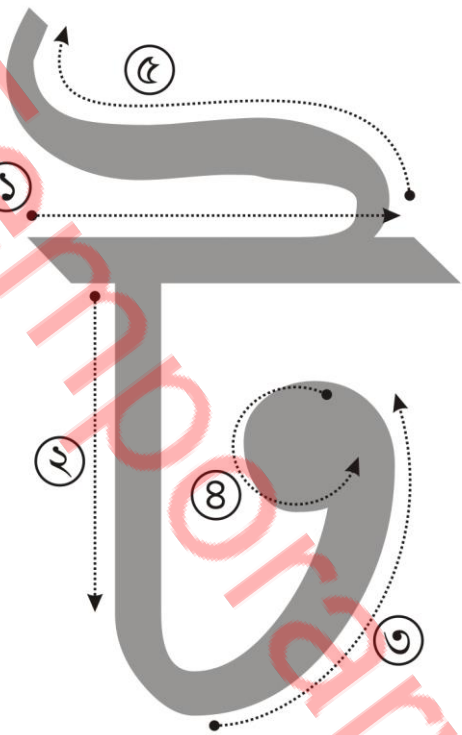

Follow the above steps

Colour it accordingly

ক	খ	গ	ঘ	ঙ	চ	ছ	জ
ঝ	ঞ	ট	ঠ	ড	ঢ	ণ	ত
থ	দ	ধ	ন	প	ফ	ব	ভ
ম	য	র	ল	শ	ষ	স	হ
ড়	ঢ়	য়	৐	৑	৒	৓	

Student Name: _____

Verified By: _____

Class: _____

Date: _____

Trace It



Student Name: _____

Verified By: _____

Class: _____

Date: _____

Trace it



Student Name: _____

Verified By: _____

Class: _____

Date: _____

Write it

ॐ	ॐ	ॐ	ॐ	ॐ	ॐ

Student Name: _____

Verified By: _____

Class: _____

Date: _____

Copy Colour



Colour it

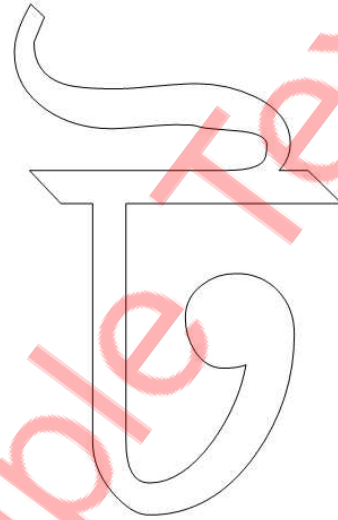

Write it

Find it

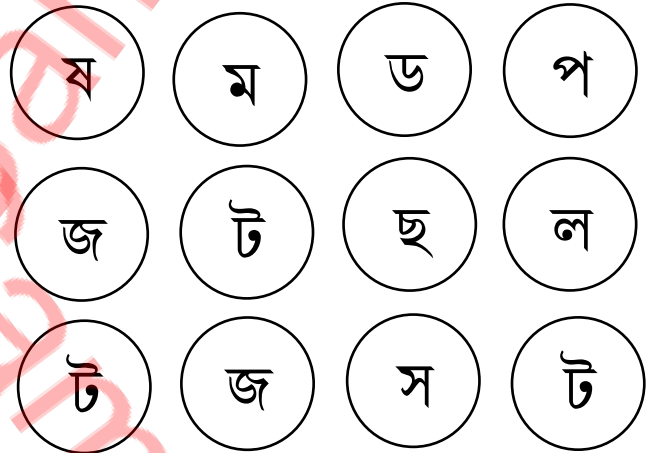
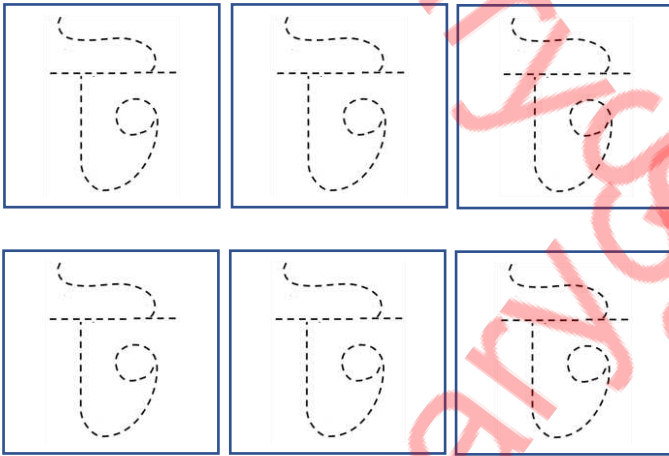

Connect the circle

Do it

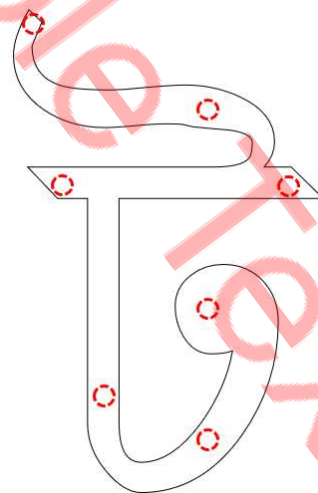
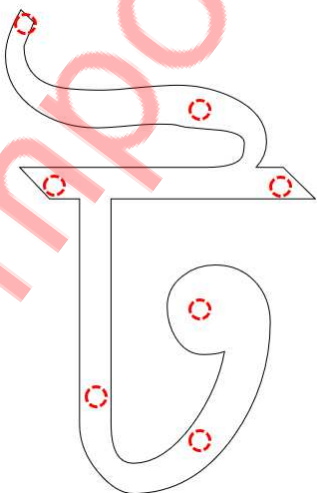

Student Name: _____

Verified By: _____

Class: _____

Date: _____

Pick the Path Find the Correct Alphabet

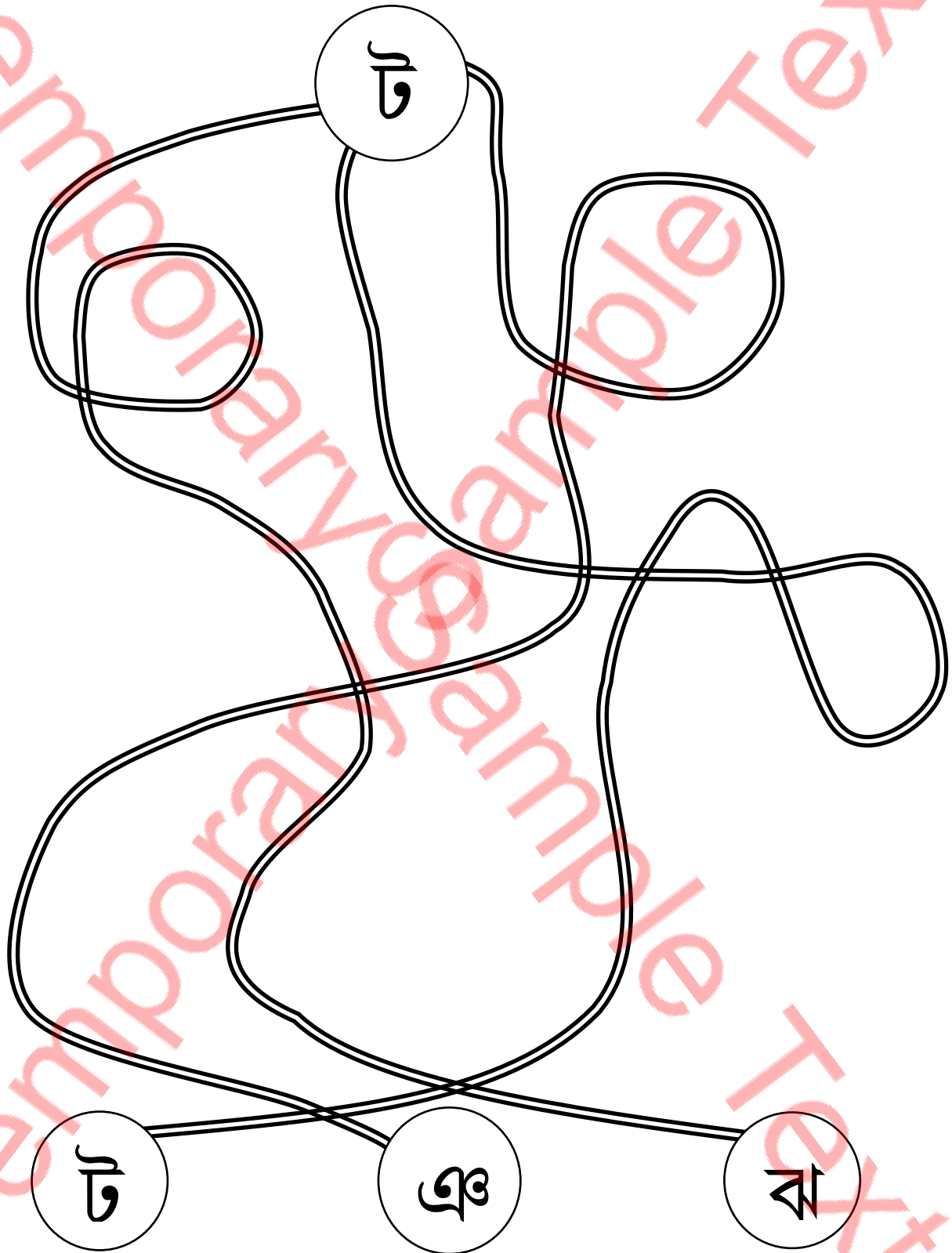

Student Name: _____

Verified By: _____

Class: _____

Date: _____

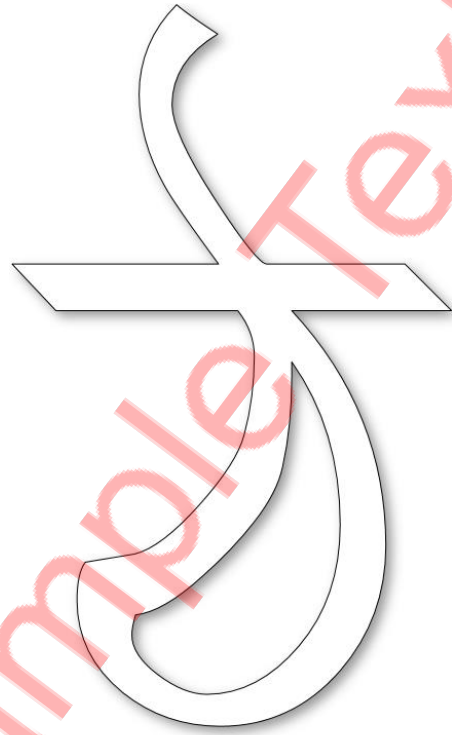
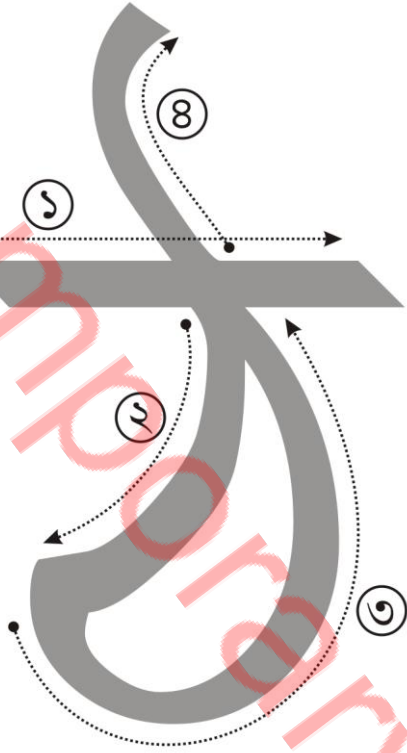

Follow the above steps

Colour it accordingly

ক	খ	গ	ঘ	ঙ	চ	ছ	জ
ঝ	ঞ	ট	ঠ	ড	ঢ	ণ	ত
থ	দ	ধ	ন	প	ফ	ব	ভ
ম	য	র	ল	শ	ষ	স	হ
ড়	ঢ়	য়	ৌ	্	ৎ	৏	

Student Name: _____

Verified By: _____

Class: _____

Date: _____

Trace It

Student Name: _____

Verified By: _____

Class: _____

Date: _____

Trace it

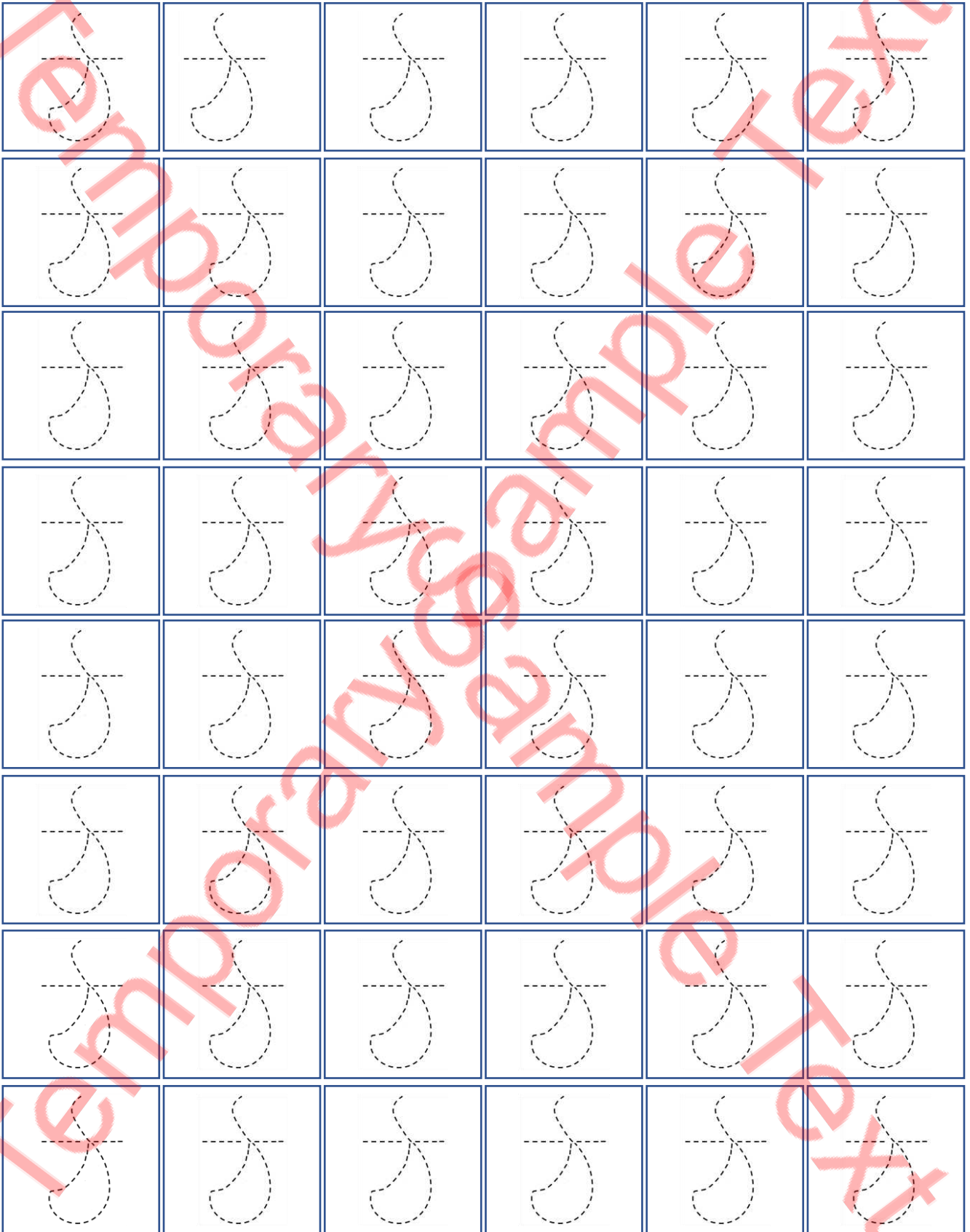

Student Name: _____

Verified By: _____

Class: _____

Date: _____

Write it

Student Name: _____

Verified By: _____

Class: _____

Date: _____

Copy Colour

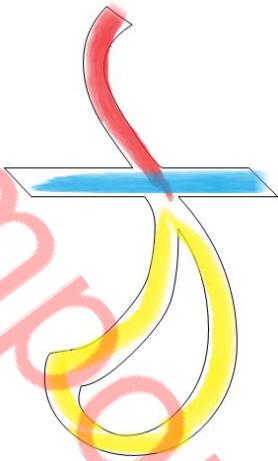

Colour it



Write it

Find it

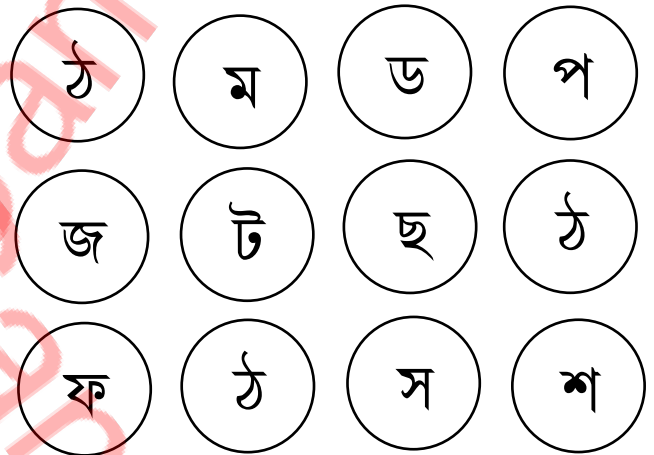
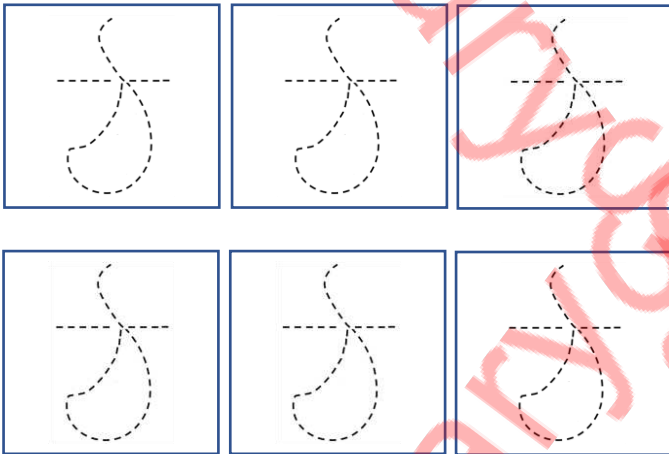

Connect the circle

Do it

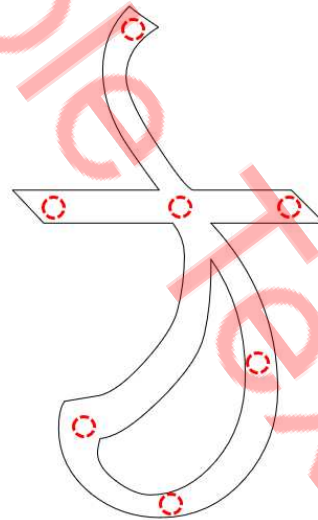
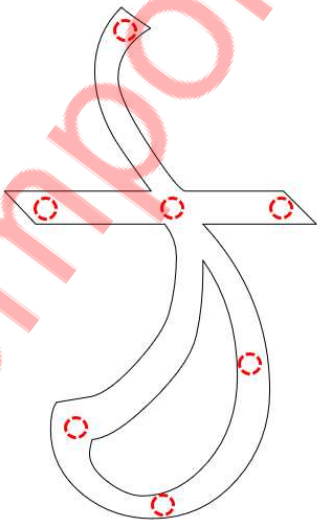

Student Name: _____

Verified By: _____

Class: _____

Date: _____

Pick the Path Find the Correct Alphabet

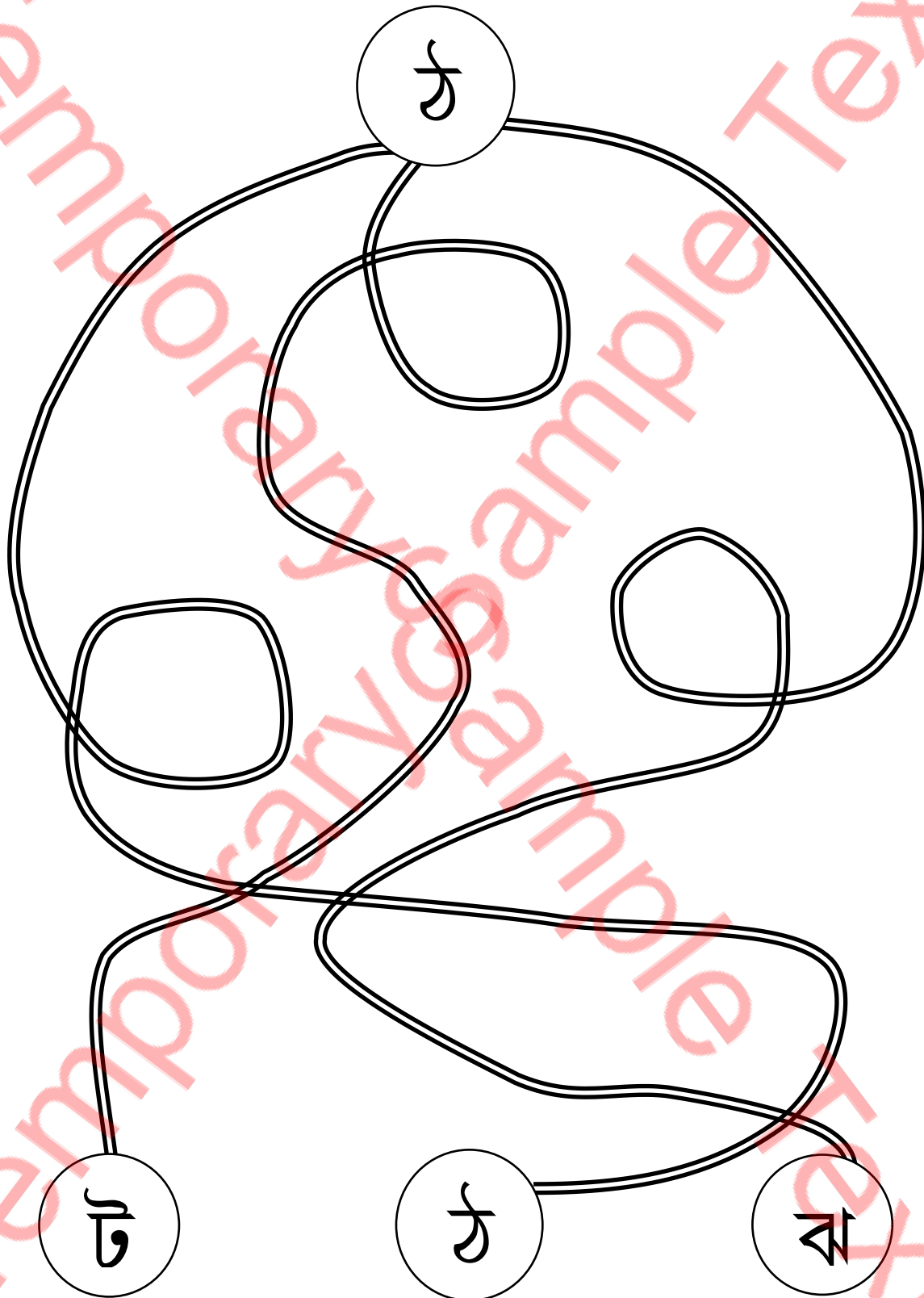

Student Name: _____

Verified By: _____

Class: _____

Date: _____

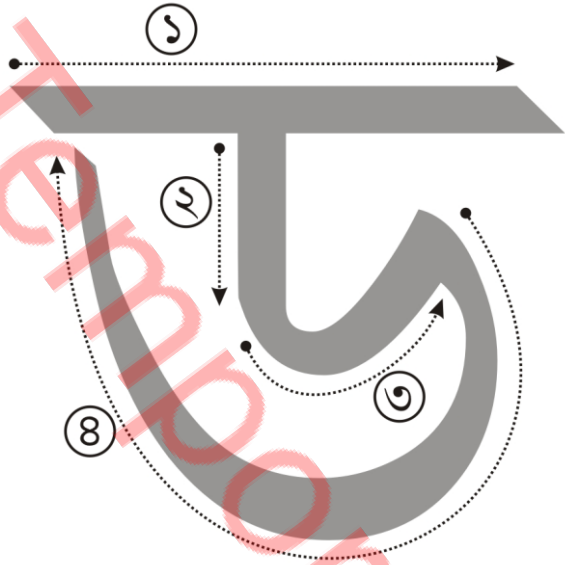

Follow the above steps

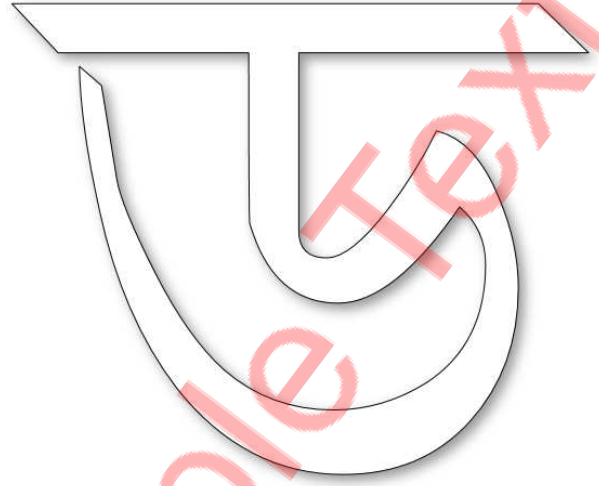

Colour it accordingly

ক	খ	গ	ঘ	ঙ	চ	ছ	জ
ঝ	ঞ	ট	ঠ	ড	ত	থ	দ
ধ	দ	ধ	ন	প	ফ	ব	ভ
ম	য	র	ল	শ	ষ	স	হ
ড়	ঢ	ণ	ৎ	ণ	ং	ং	

Student Name: _____

Verified By: _____

Class: _____

Date: _____

Trace It

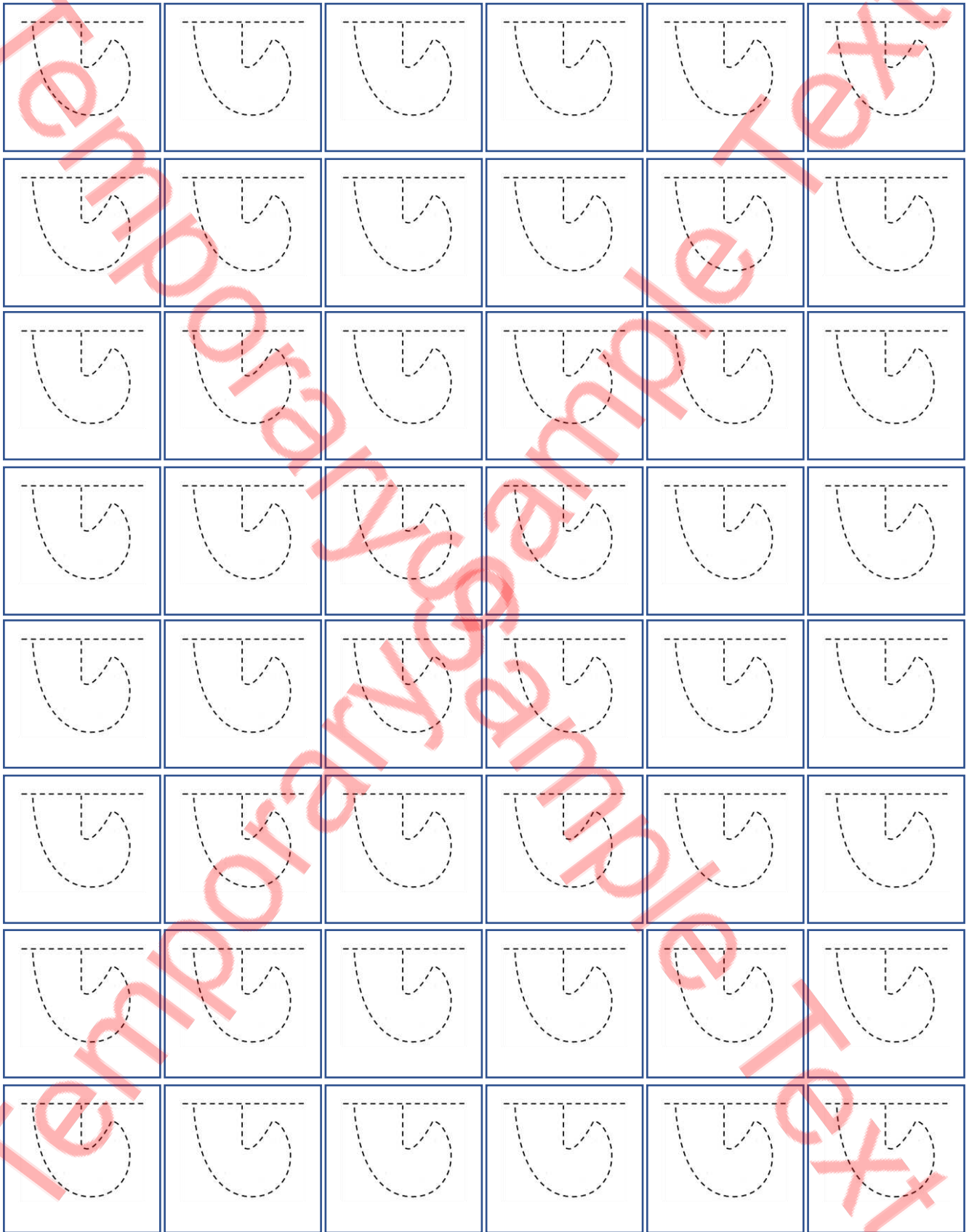

Student Name: _____

Verified By: _____

Class: _____

Date: _____

Trace it

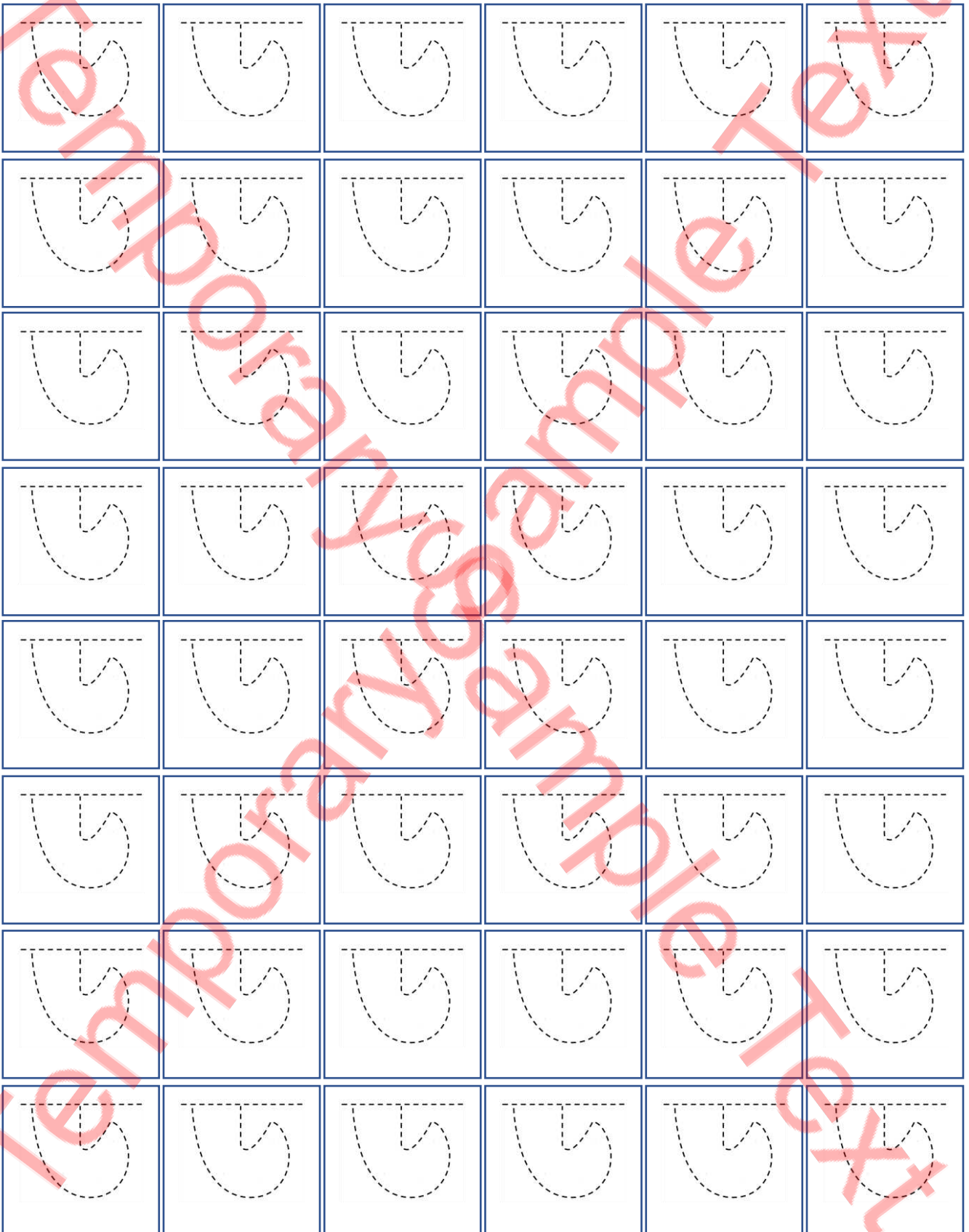

Student Name: _____

Verified By: _____

Class: _____

Date: _____

Write it

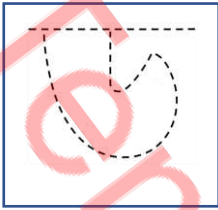
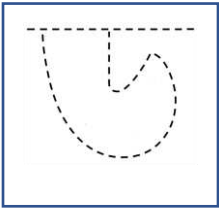
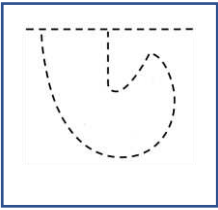
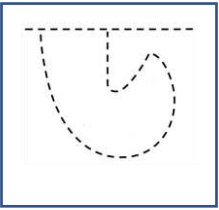
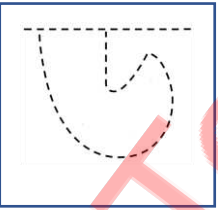
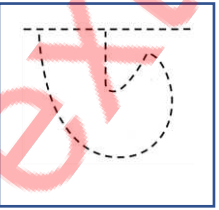
Student Name: _____

Verified By: _____

Class: _____

Date: _____

Copy Colour

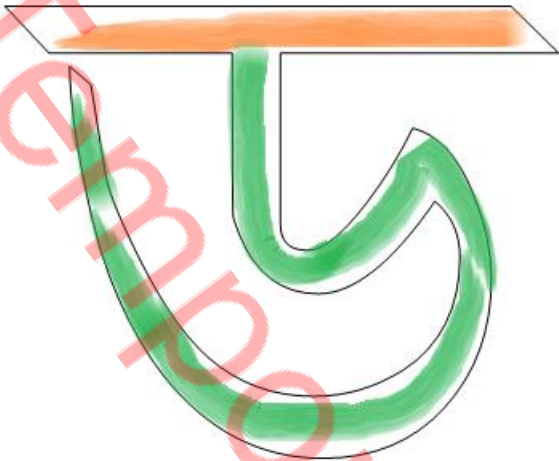

Colour it

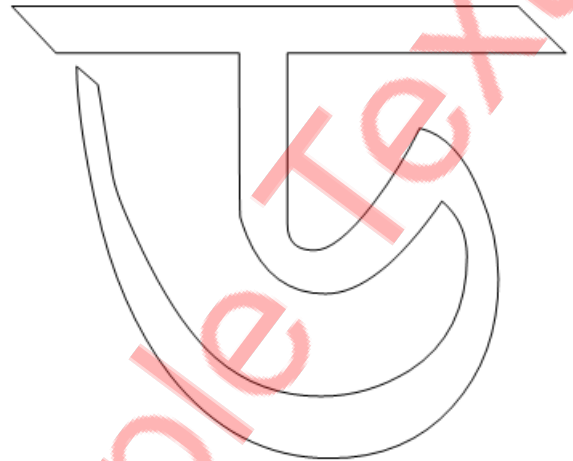

Write it

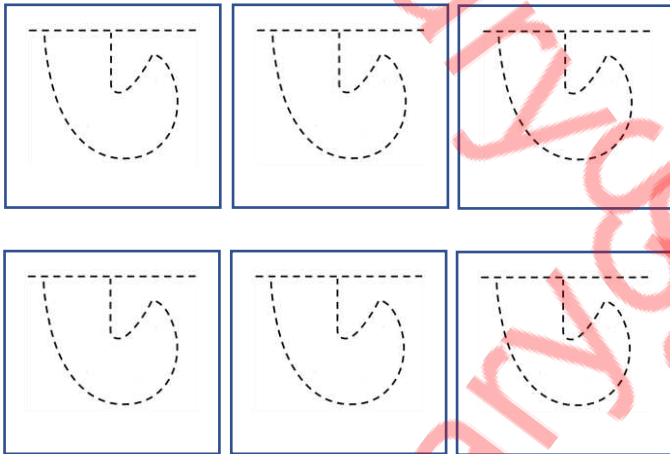

Find it

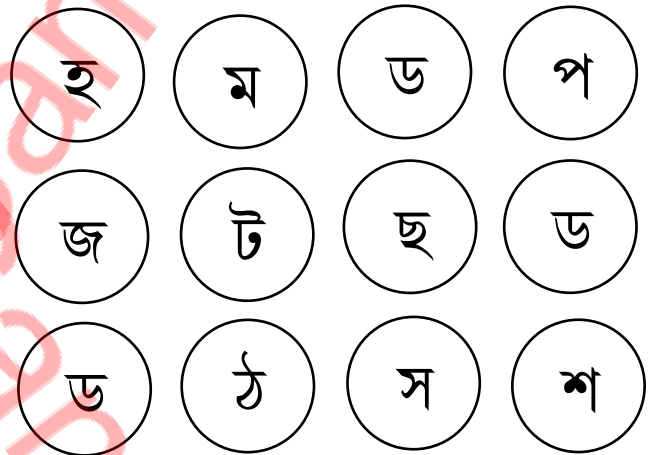

Connect the circle

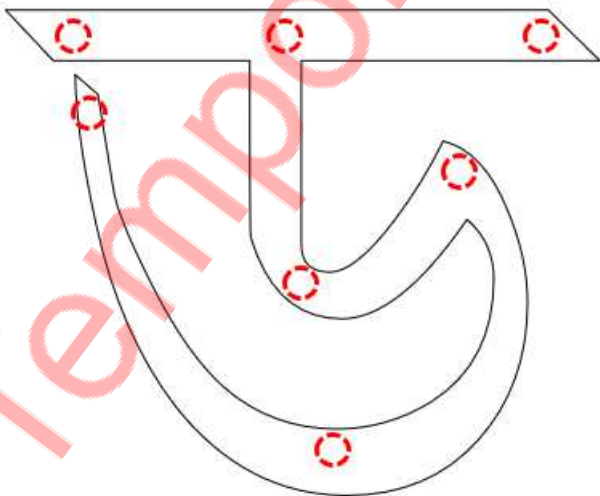

Do it

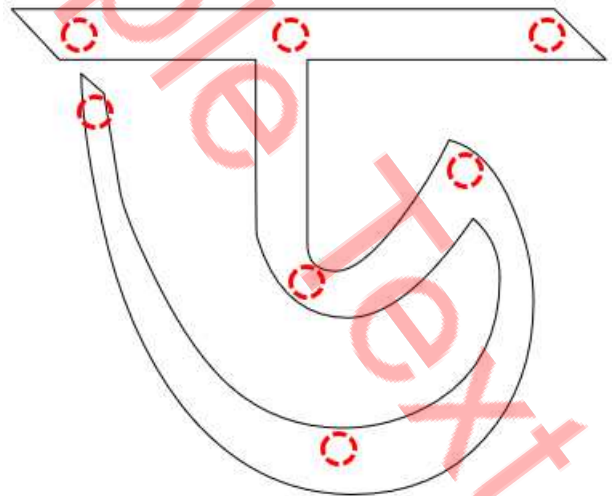

Student Name: _____

Verified By: _____

Class: _____

Date: _____

Pick the Path Find the Correct Alphabet

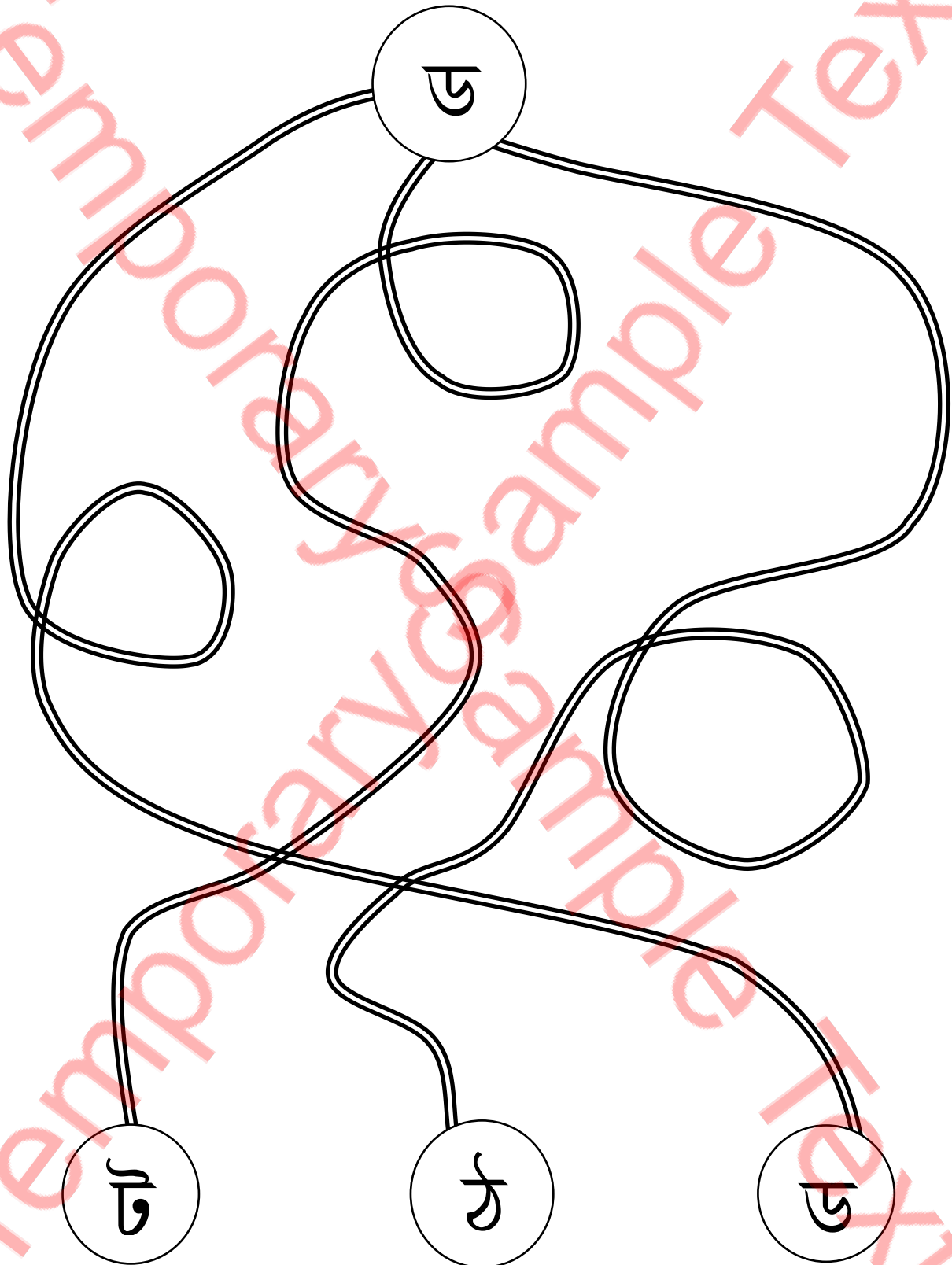

Student Name: _____

Verified By: _____

Class: _____

Date: _____

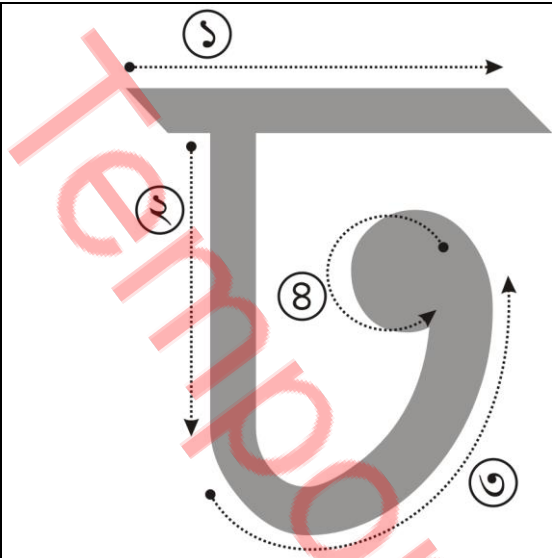

Follow the above steps

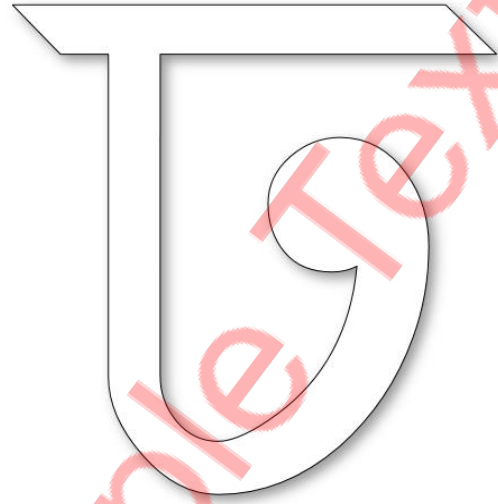

Colour it accordingly

ক	খ	গ	ঘ	ঙ	চ	ছ	জ
ঝ	ঞ	ট	ঠ	ড	ত	ণ	ত
থ	দ	ধ	ন	প	ফ	ব	ভ
ম	য	র	ত্র	শ	ষ	স	হ
ড়	ঢ	ণ	ৎ	ৎ	ৎ	ৎ	

Student Name: _____

Verified By: _____

Class: _____

Date: _____

Trace It

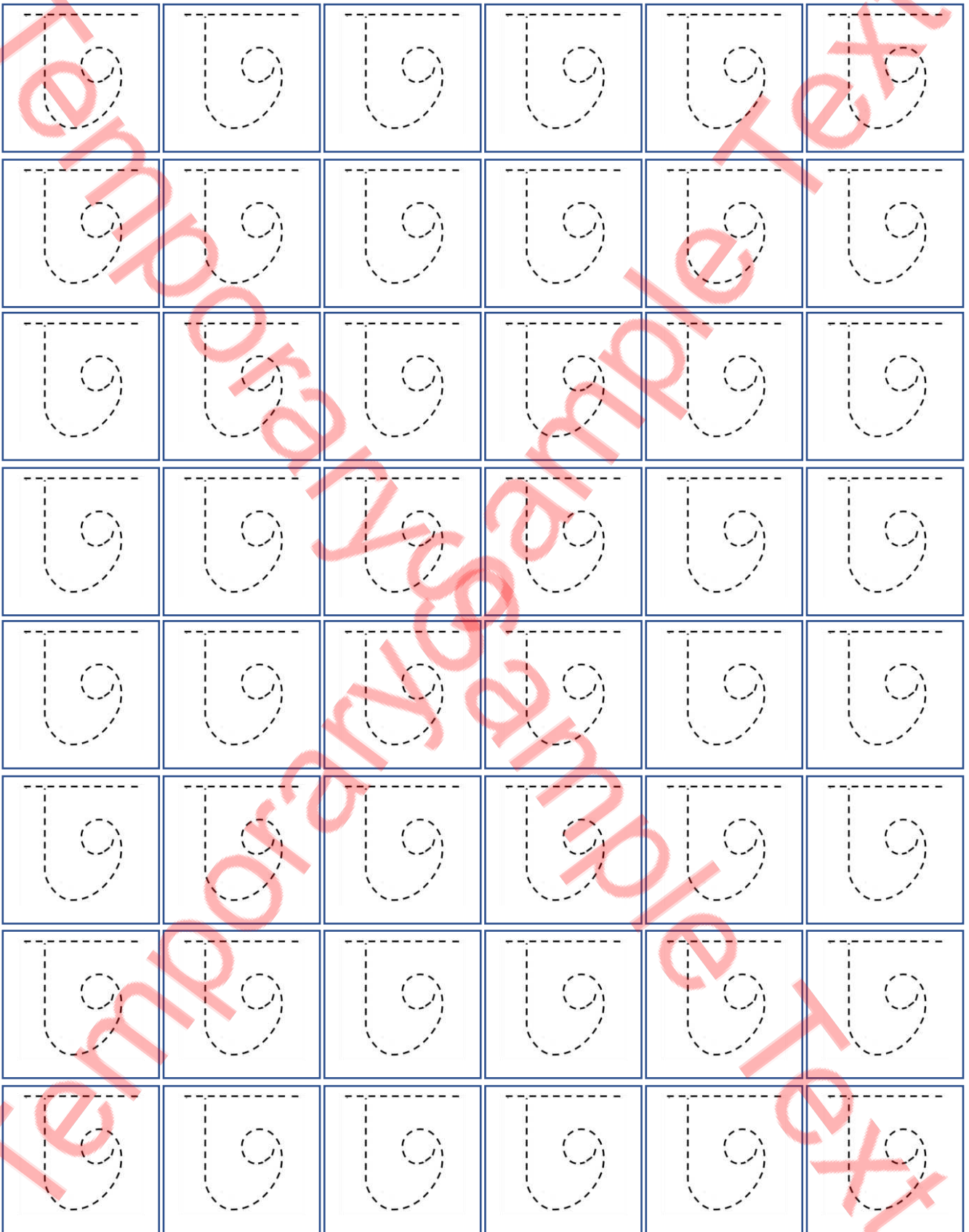

Student Name: _____

Verified By: _____

Class: _____

Date: _____

Trace it

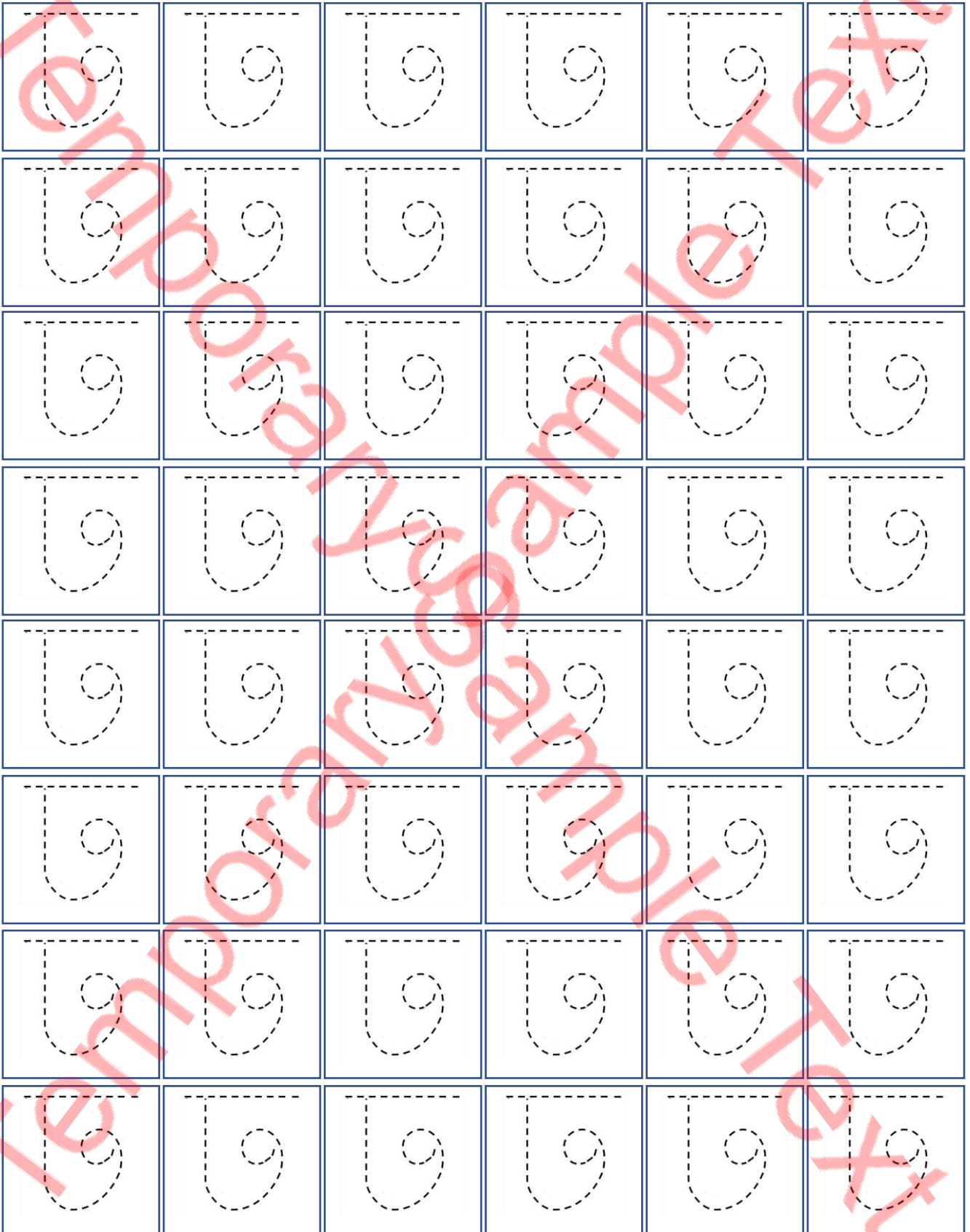

Student Name: _____

Verified By: _____

Class: _____

Date: _____

Write it

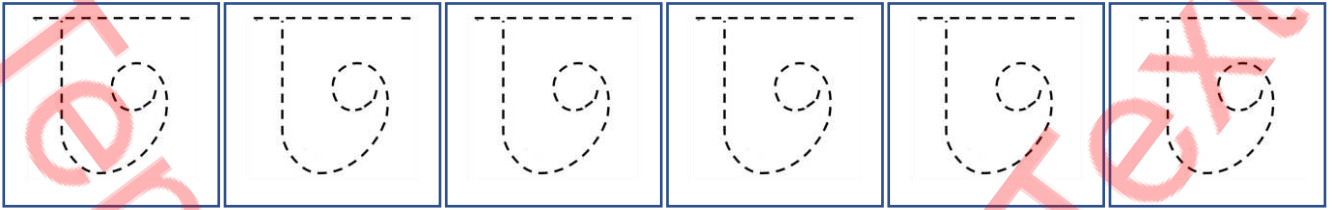

Student Name: _____

Verified By: _____

Class: _____

Date: _____

Copy Colour

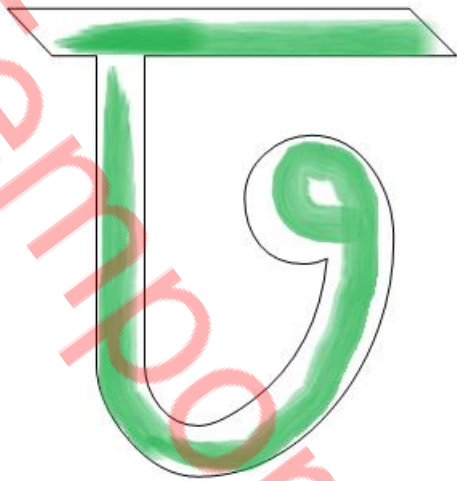

Colour it

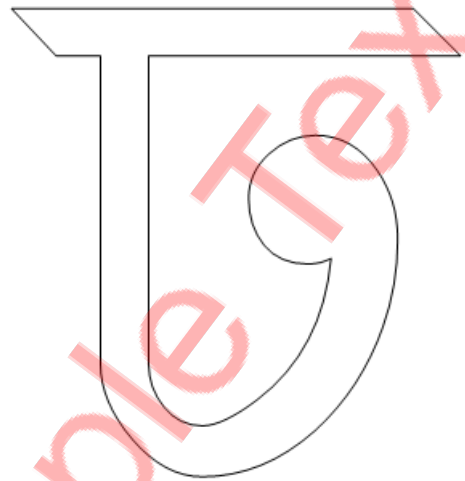

Write it

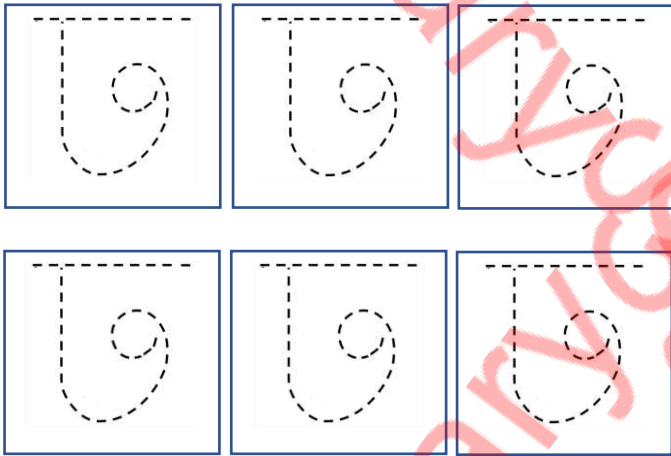

Find it

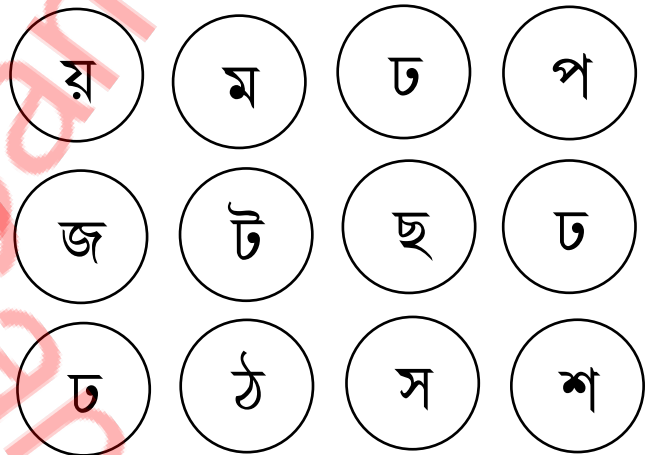

Connect the circle

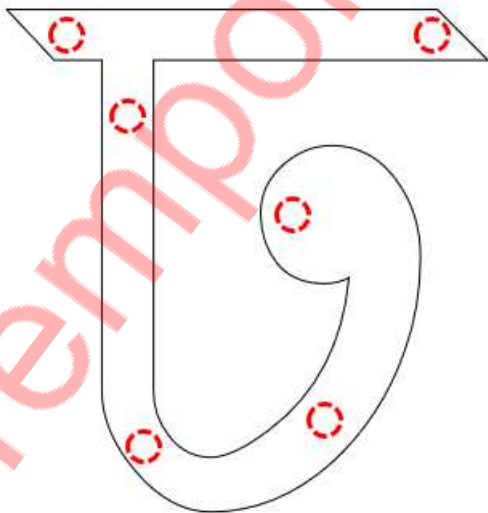

Do it

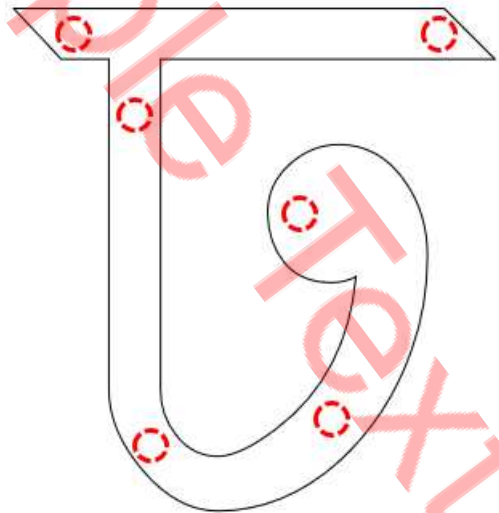

Student Name: _____

Verified By: _____

Class: _____

Date: _____

Pick the Path Find the Correct Alphabet

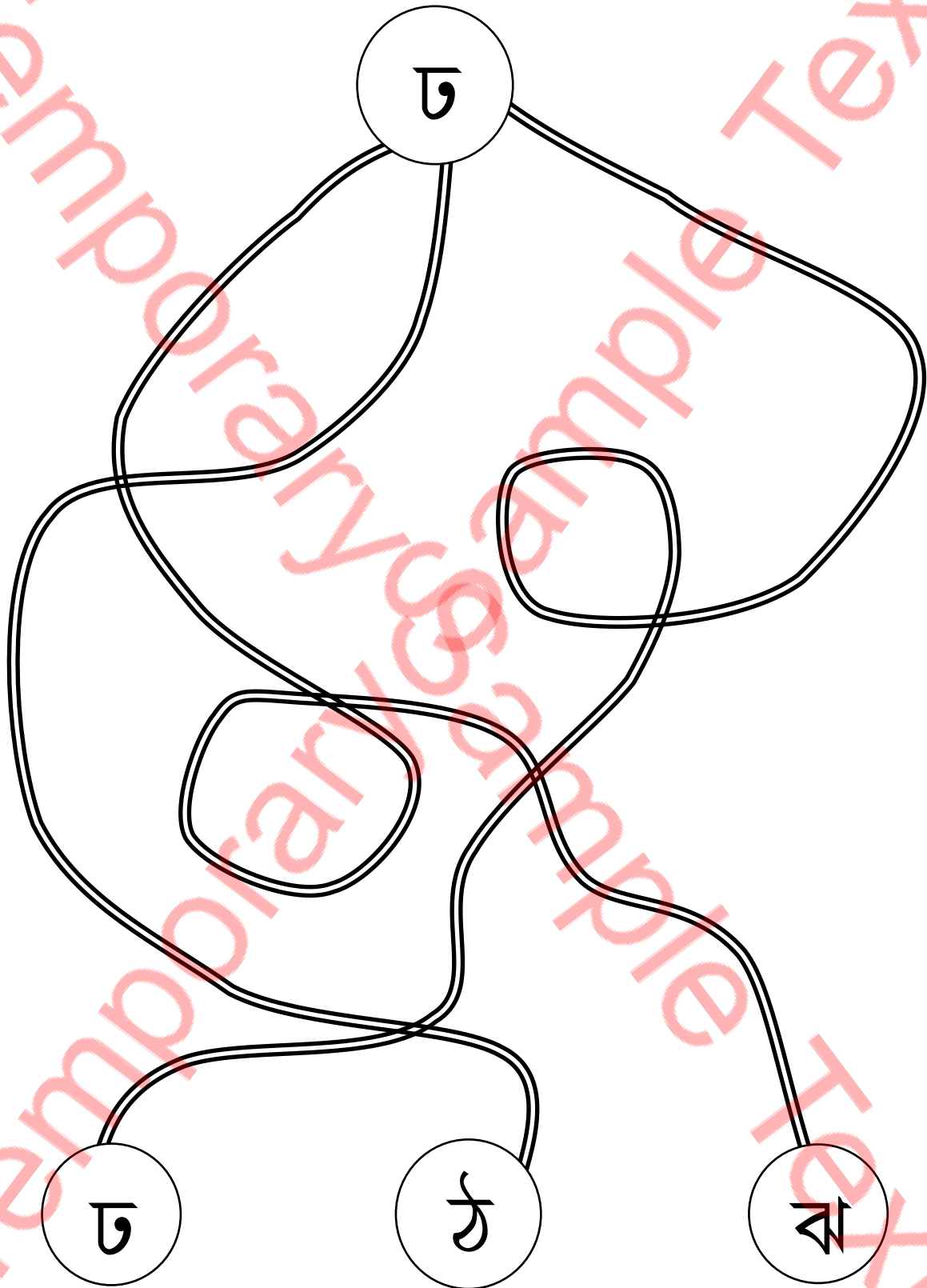

Student Name: _____

Verified By: _____

Class: _____

Date: _____

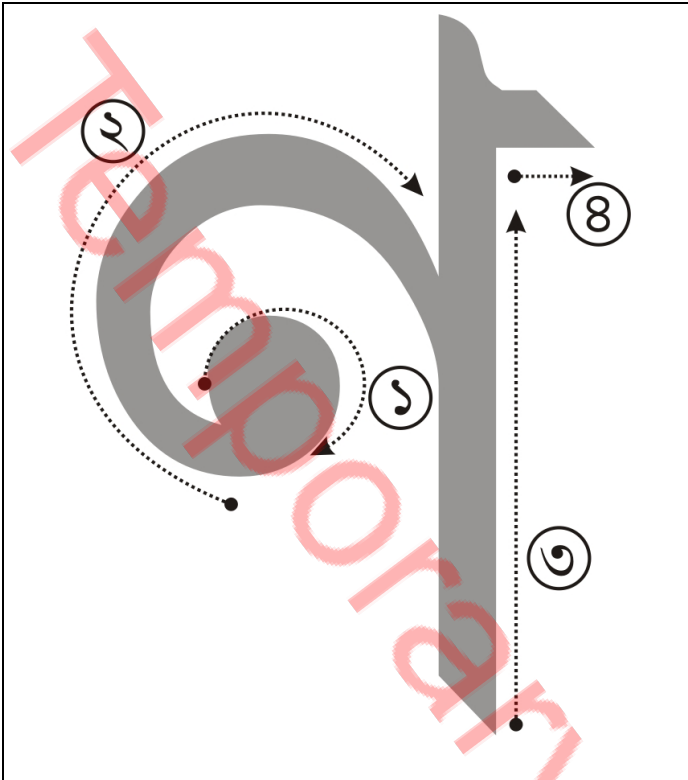

Follow the above steps

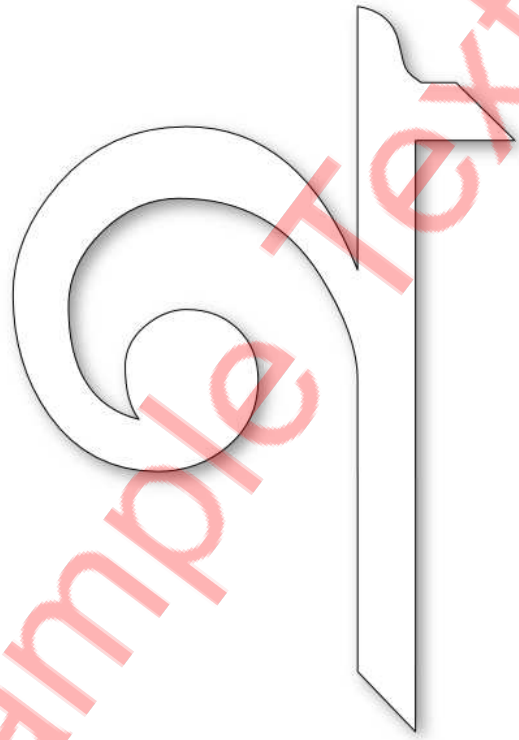

Colour it accordingly

ক	খ	গ	ঘ	ঙ	চ	ছ	জ
ঝ	ঞ	ট	ঠ	ড	ঢ	ণ	ত
থ	দ	ধ	ন	প	ফ	ব	ভ
ম	য	র	ল	শ	ষ	স	হ
ড়	ঢ়	ণ্ণ	ত্ৰ	ত্ৰ	ত্ৰ	ত্ৰ	ত্ৰ

Student Name: _____

Verified By: _____

Class: _____

Date: _____

Trace It

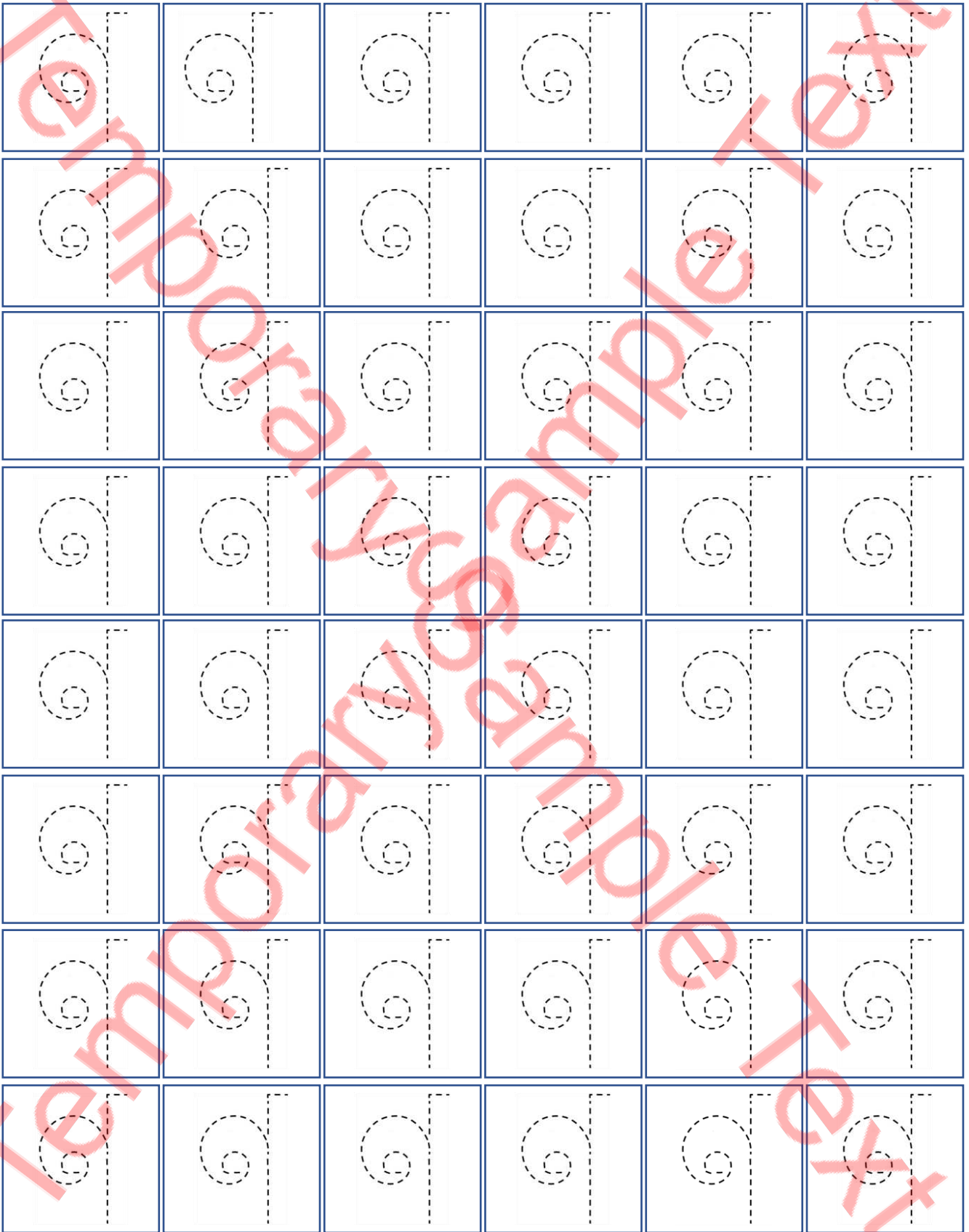

Student Name: _____

Verified By: _____

Class: _____

Date: _____

Trace it

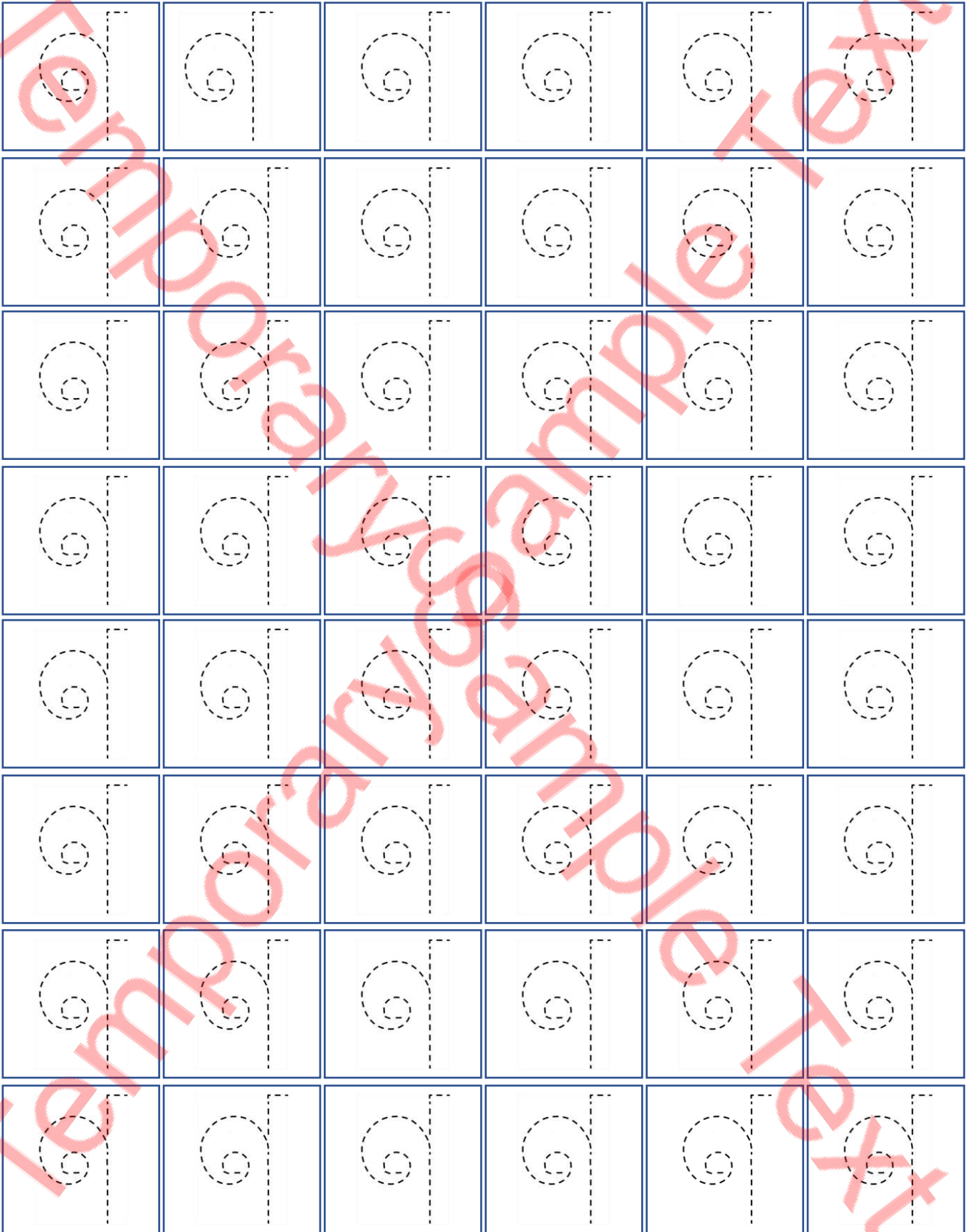

Student Name: _____

Verified By: _____

Class: _____

Date: _____

Write it

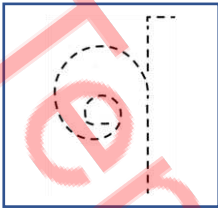
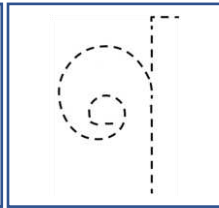
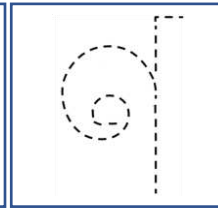
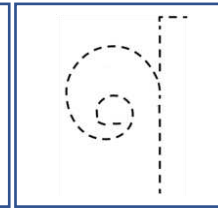
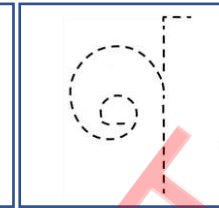
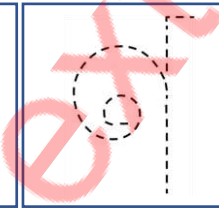
Student Name: _____

Verified By: _____

Class: _____

Date: _____

Copy Colour

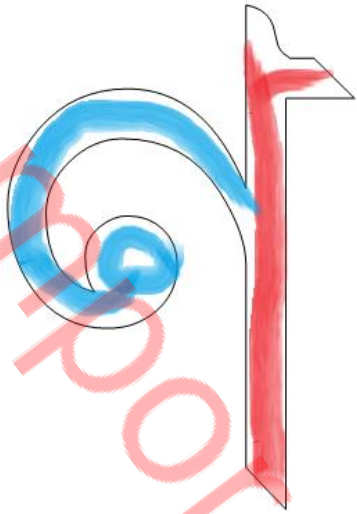

Colour it

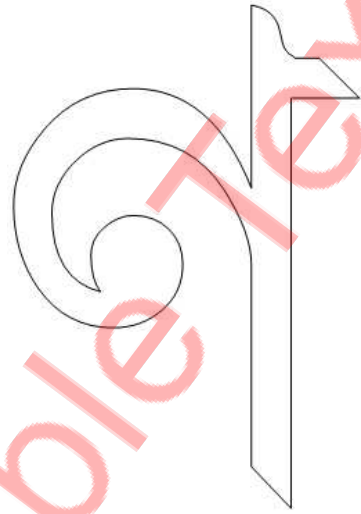

Write it

Find it

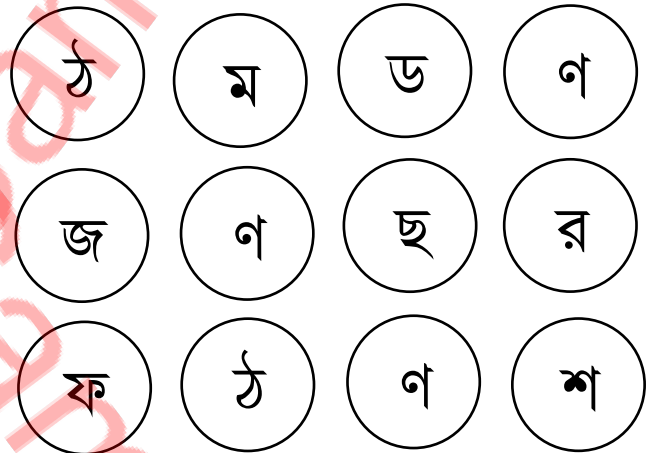
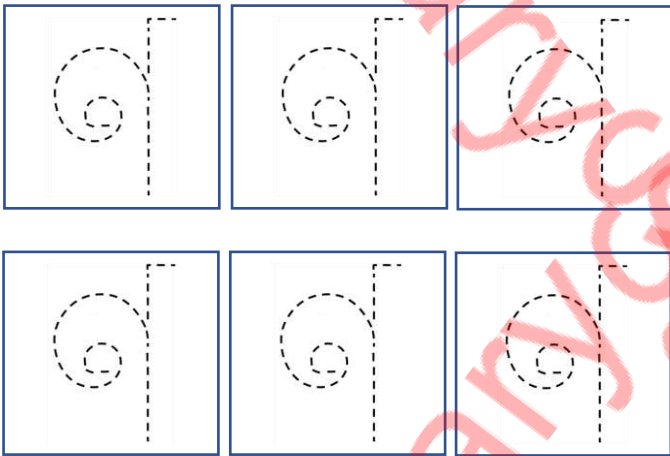

Connect the circle

Do it

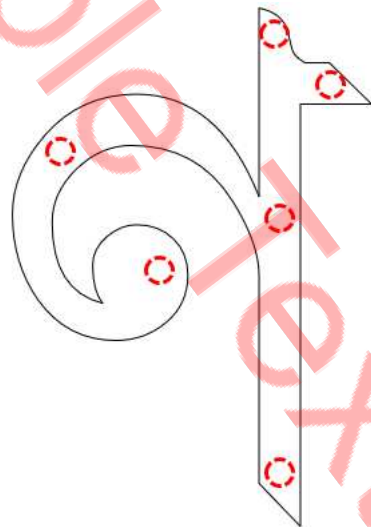
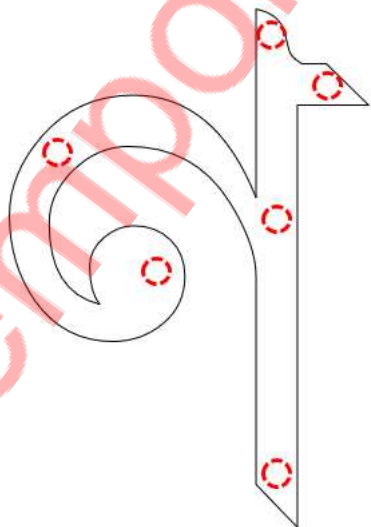

Student Name: _____

Verified By: _____

Class: _____

Date: _____

Pick the Path Find the Correct Alphabet

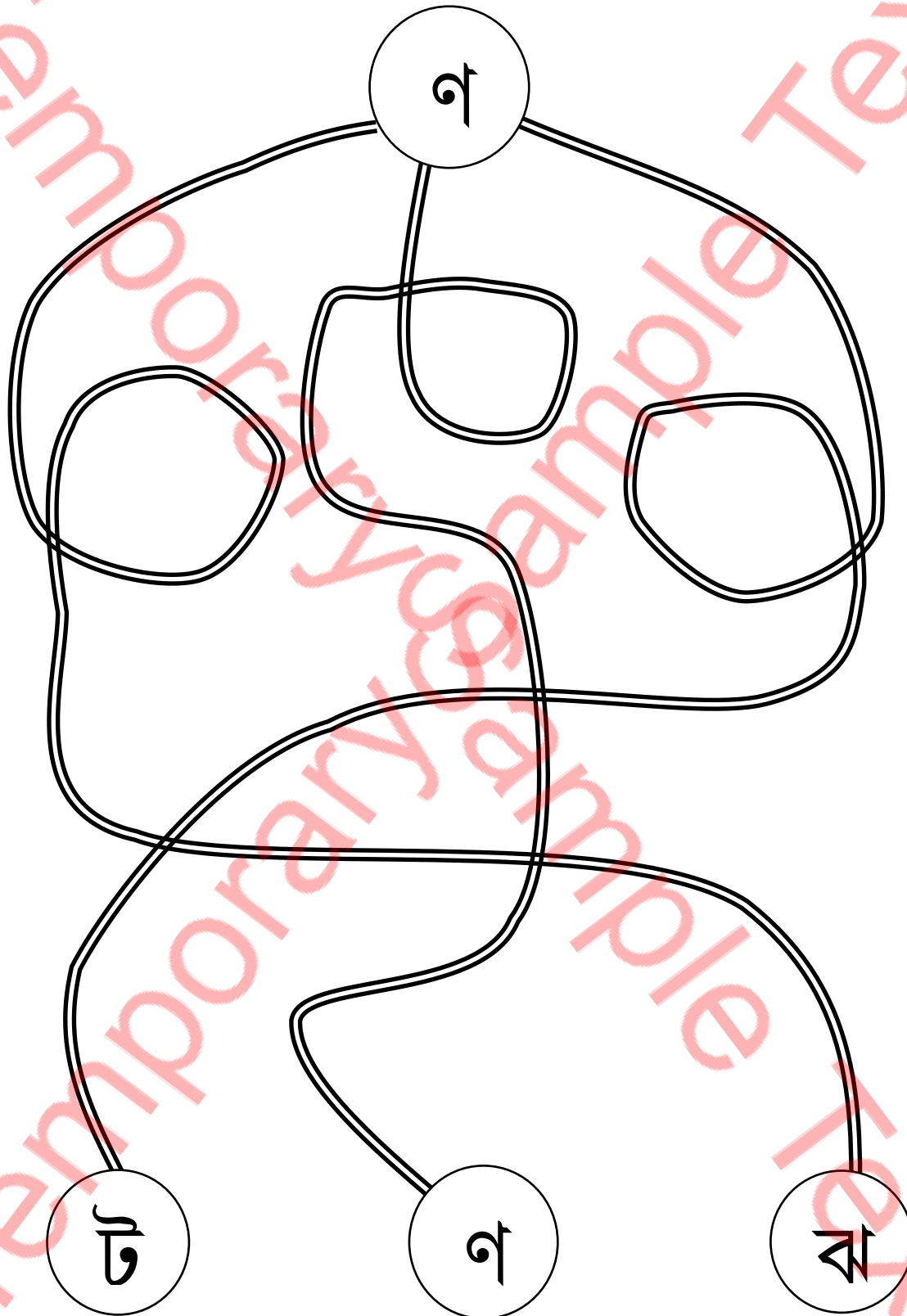

Student Name: _____

Verified By: _____

Class: _____

Date: _____

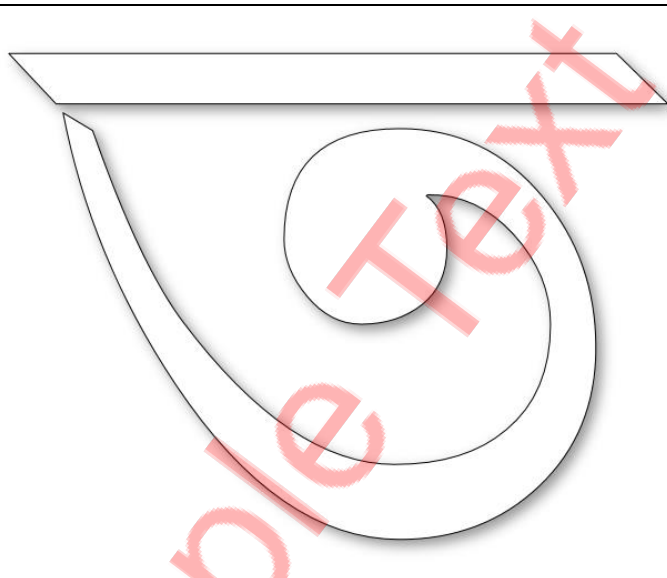
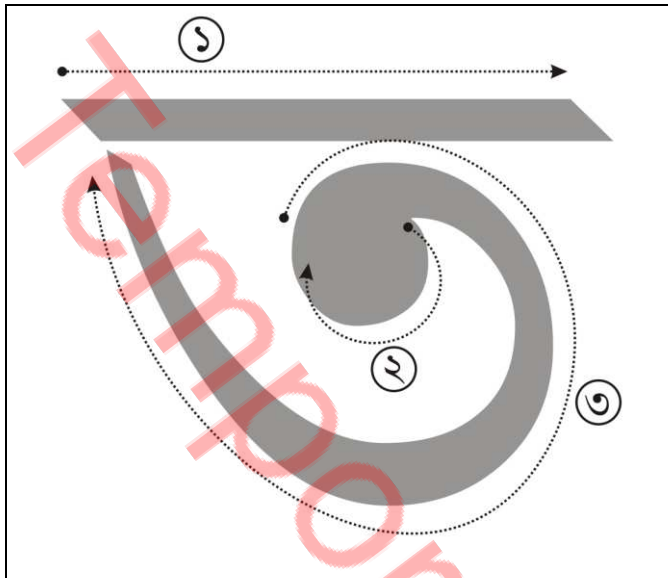

Follow the above steps

Colour it accordingly

ক	খ	গ	ঘ	ঙ	চ	ছ	জ
ঝ	ঞ	ট	ঠ	ড	ঢ	ণ	ত
থ	দ	ধ	ন	প	ফ	ব	ভ
ম	য	র	ল	শ	ষ	স	হ
ড়	ঢ়	য়	ৱ	৲	৳	৴	

Student Name: _____

Verified By: _____

Class: _____

Date: _____

Trace It



Student Name: _____

Verified By: _____

Class: _____

Date: _____

Trace it

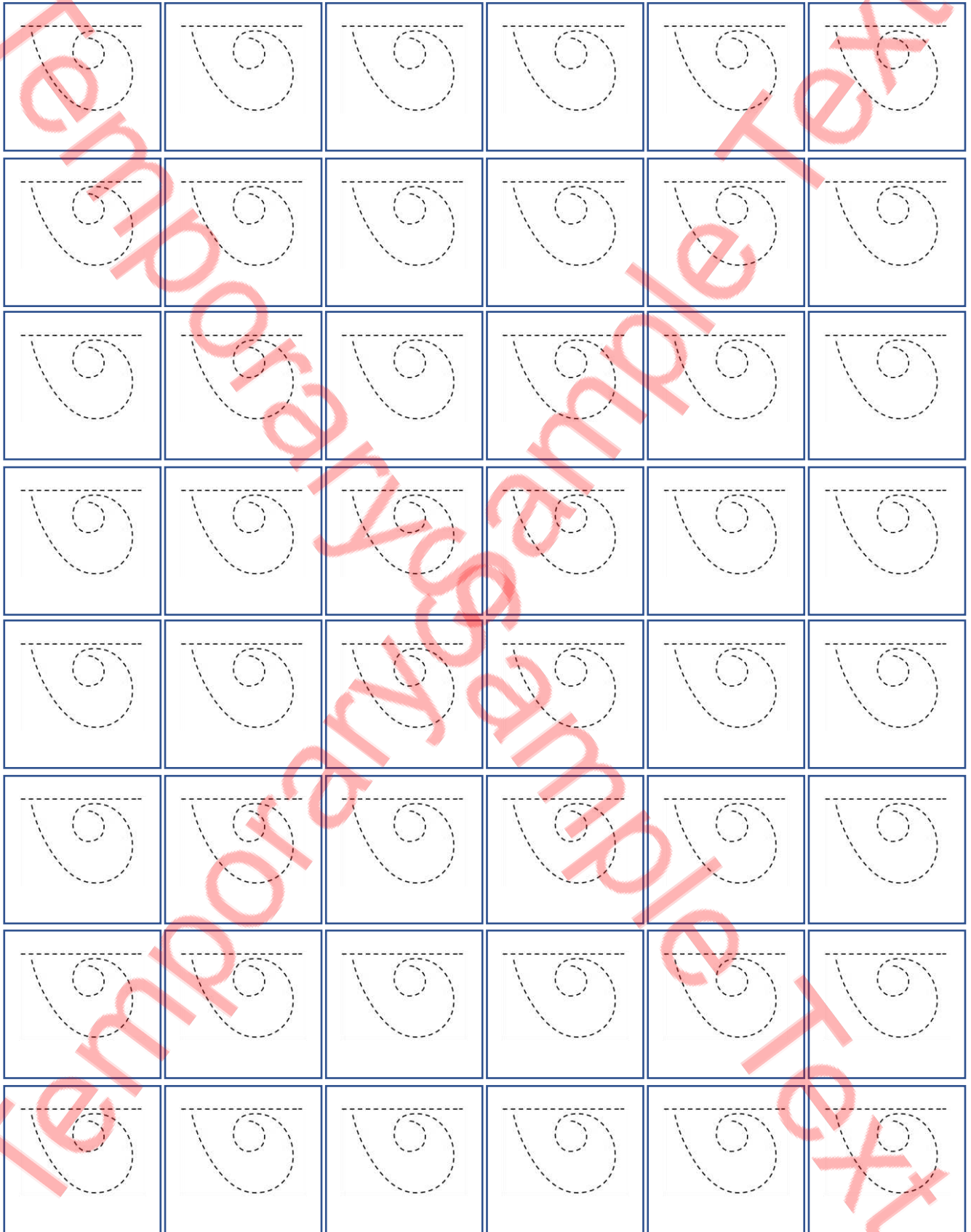

Student Name: _____

Verified By: _____

Class: _____

Date: _____

Write it

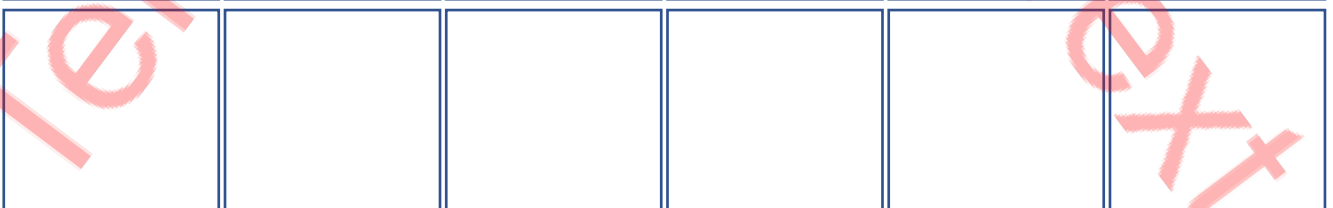
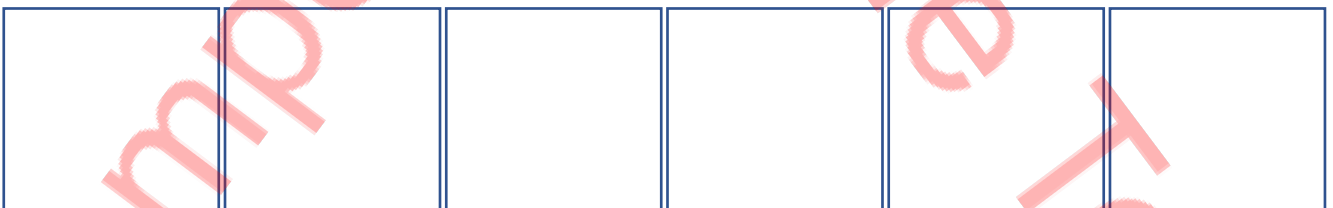
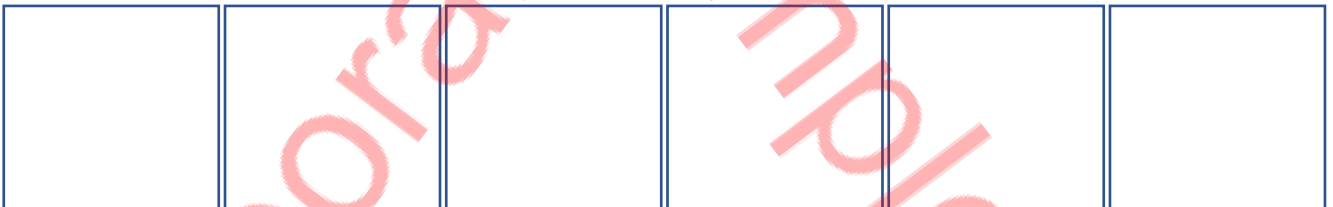
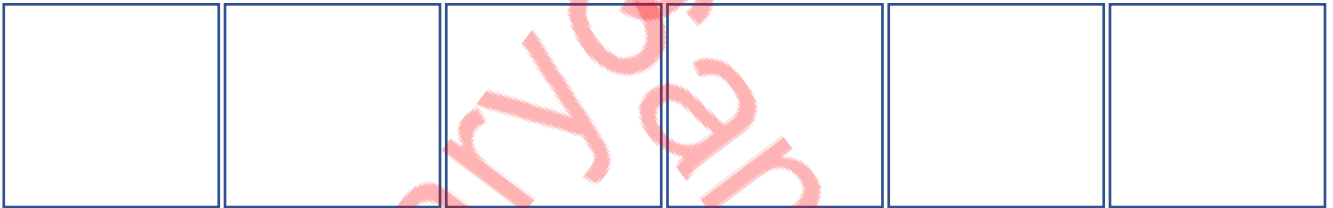
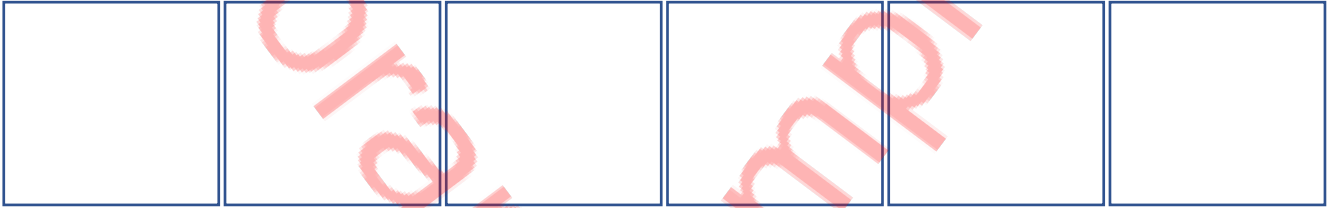
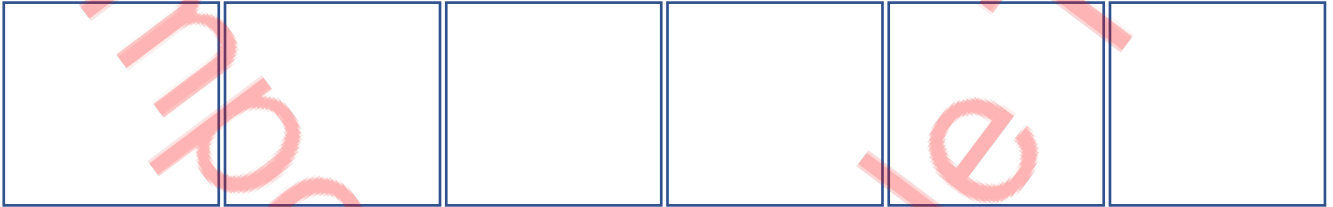
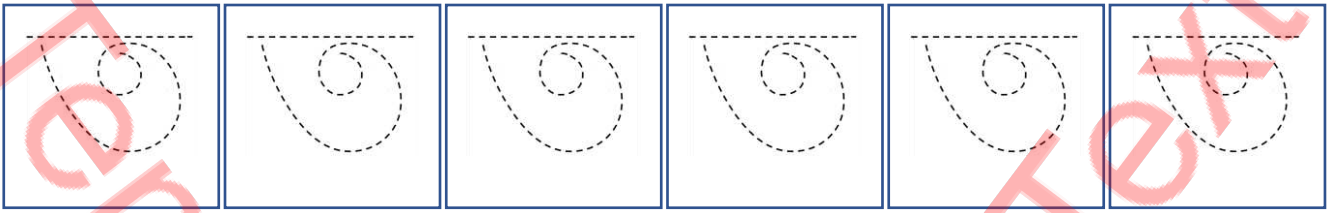

Student Name: _____

Verified By: _____

Class: _____

Date: _____

Copy Colour

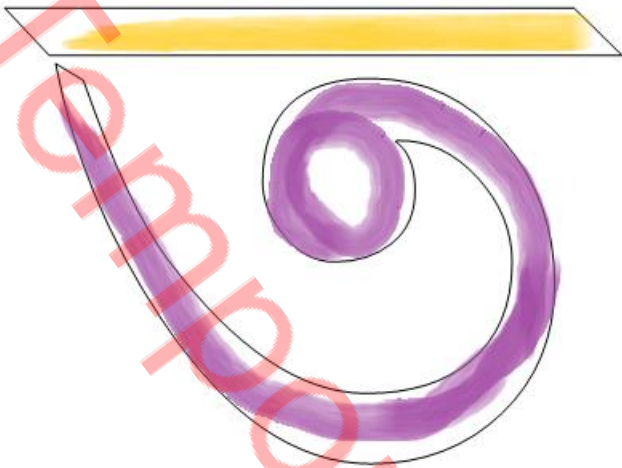

Colour it

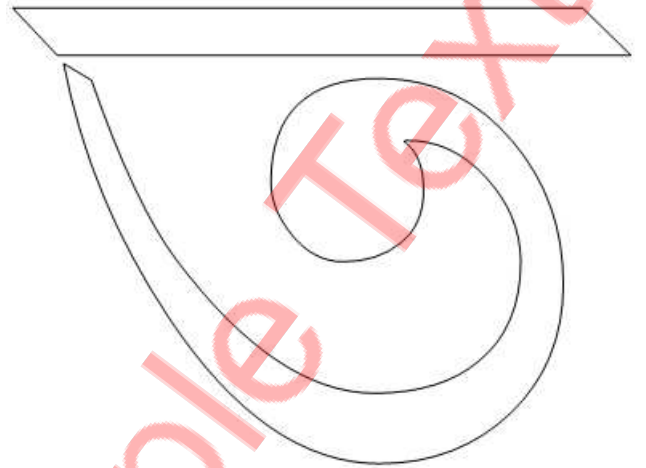

Write it

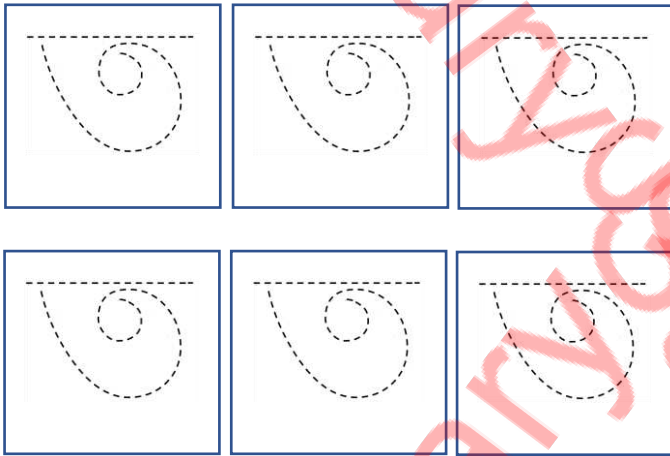

Find it

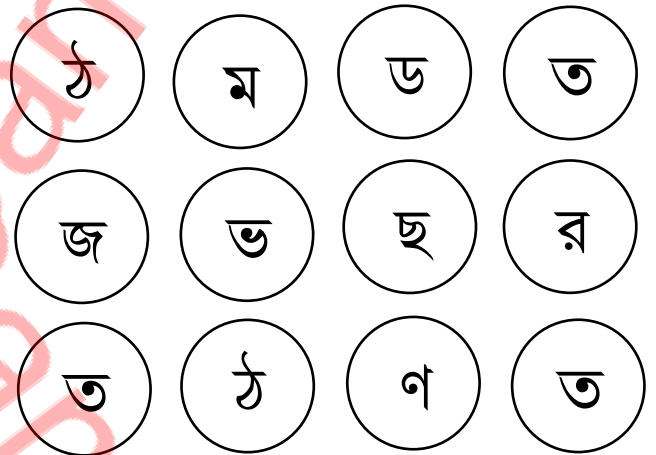

Connect the circle

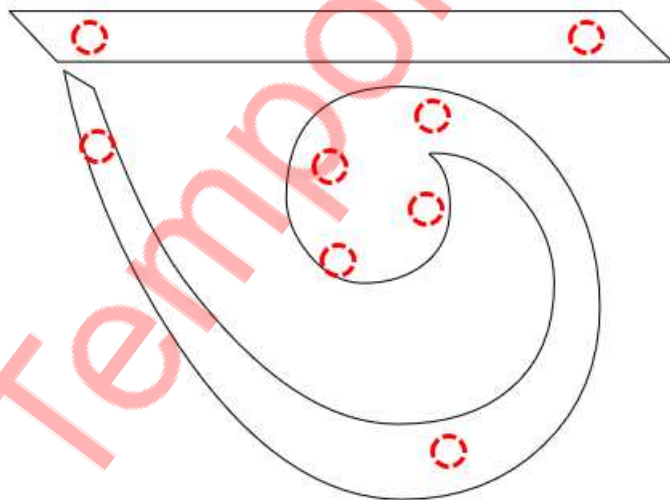

Do it

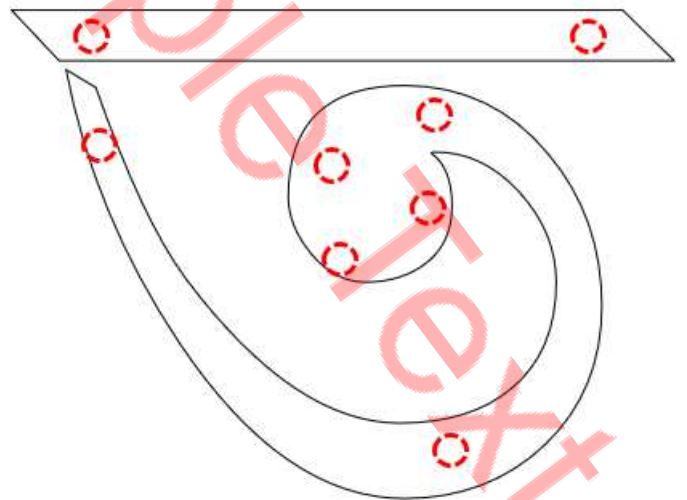

Student Name: _____

Verified By: _____

Class: _____

Date: _____

Pick the Path Find the Correct Alphabet

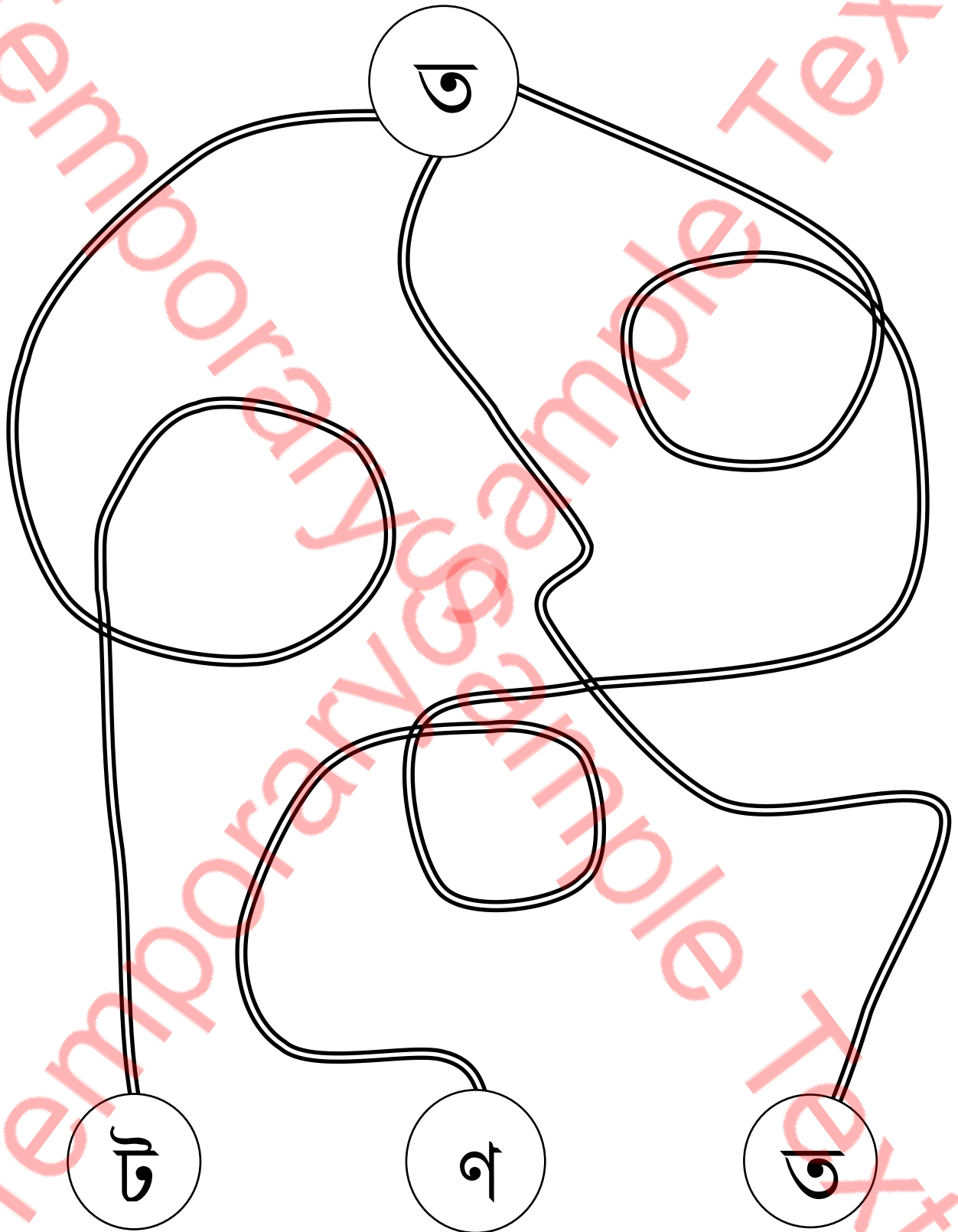

Student Name: _____

Verified By: _____

Class: _____

Date: _____

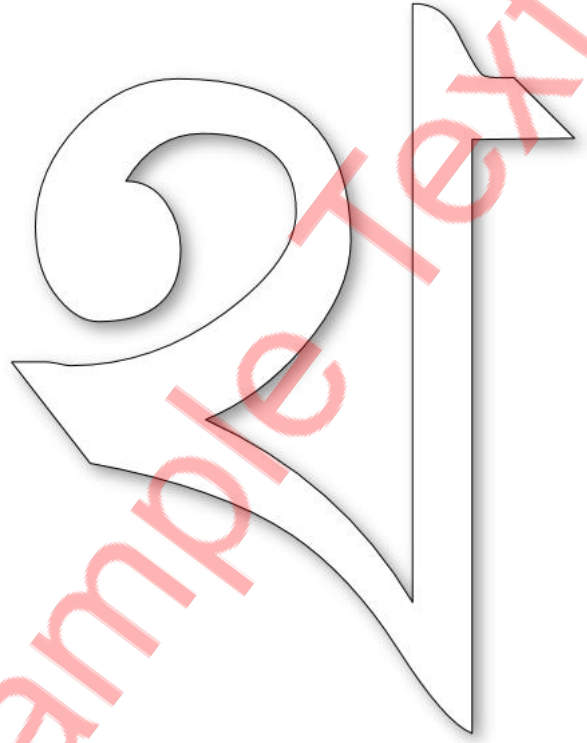
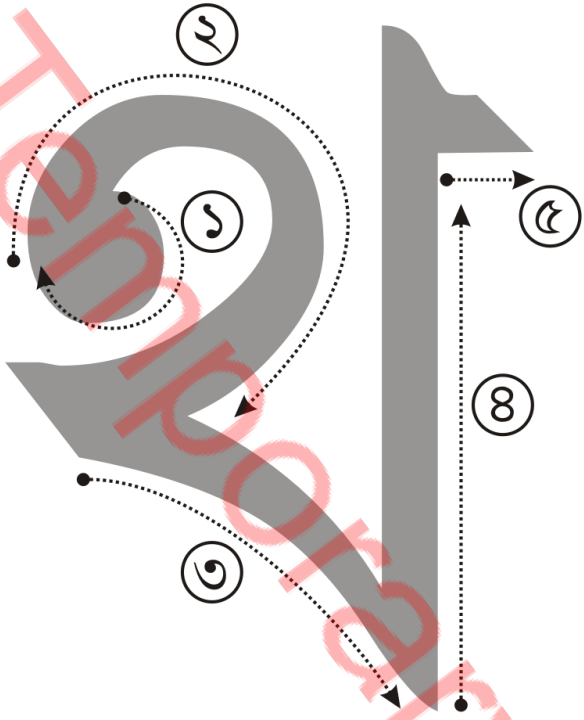

Follow the above steps

Colour it accordingly

ক	খ	গ	ঘ	ঙ	চ	ছ	জ
ঝ	ঞ	ট	ঠ	ড	ঢ	ণ	ত
থ	দ	ধ	ন	প	ফ	ব	ভ
ম	য	র	ল	শ	ষ	স	হ
ড়	ঢ়	য়	ৱ	৲	৳	৴	

Student Name: _____

Verified By: _____

Class: _____

Date: _____

Trace It

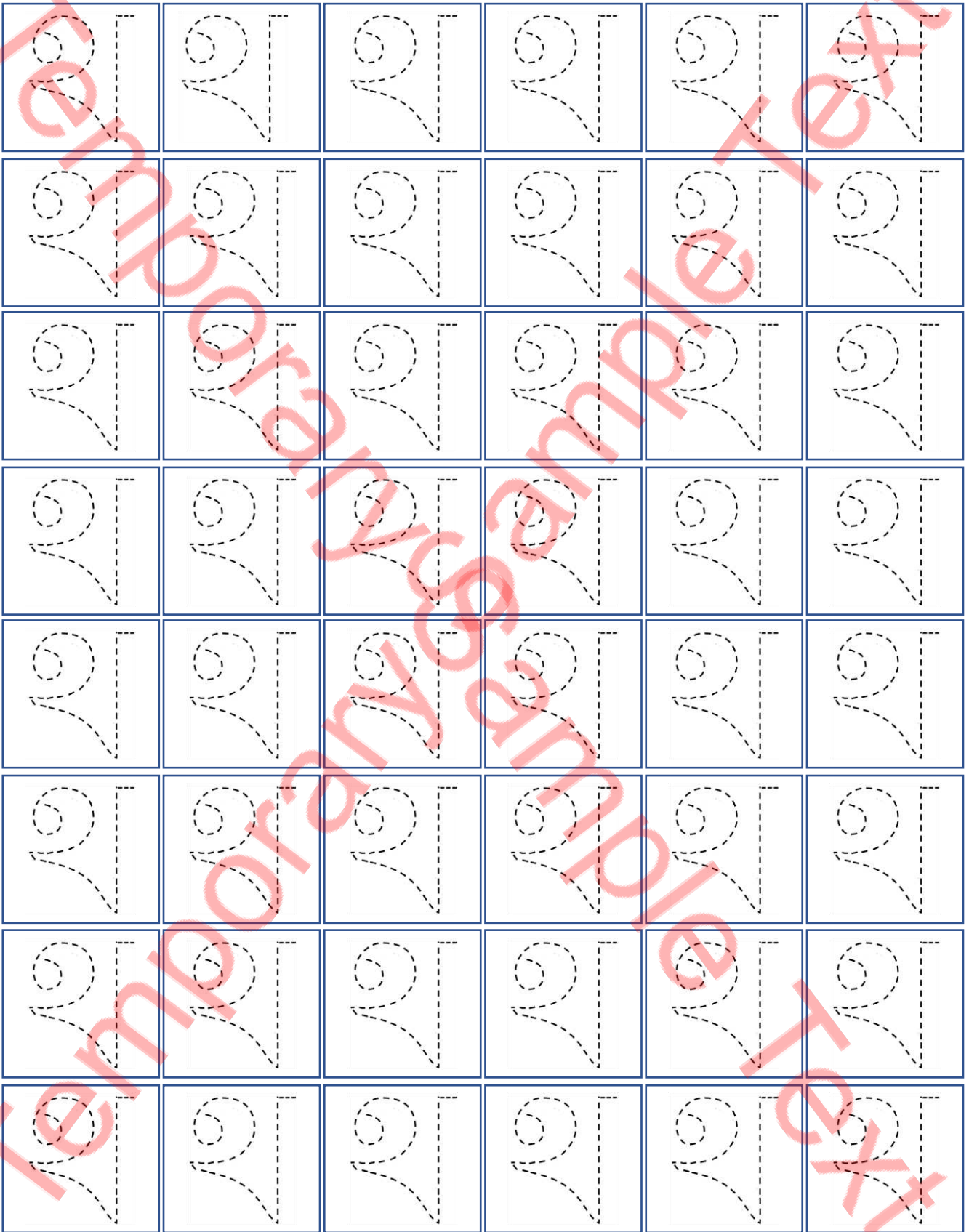

Student Name: _____

Verified By: _____

Class: _____

Date: _____

Trace it

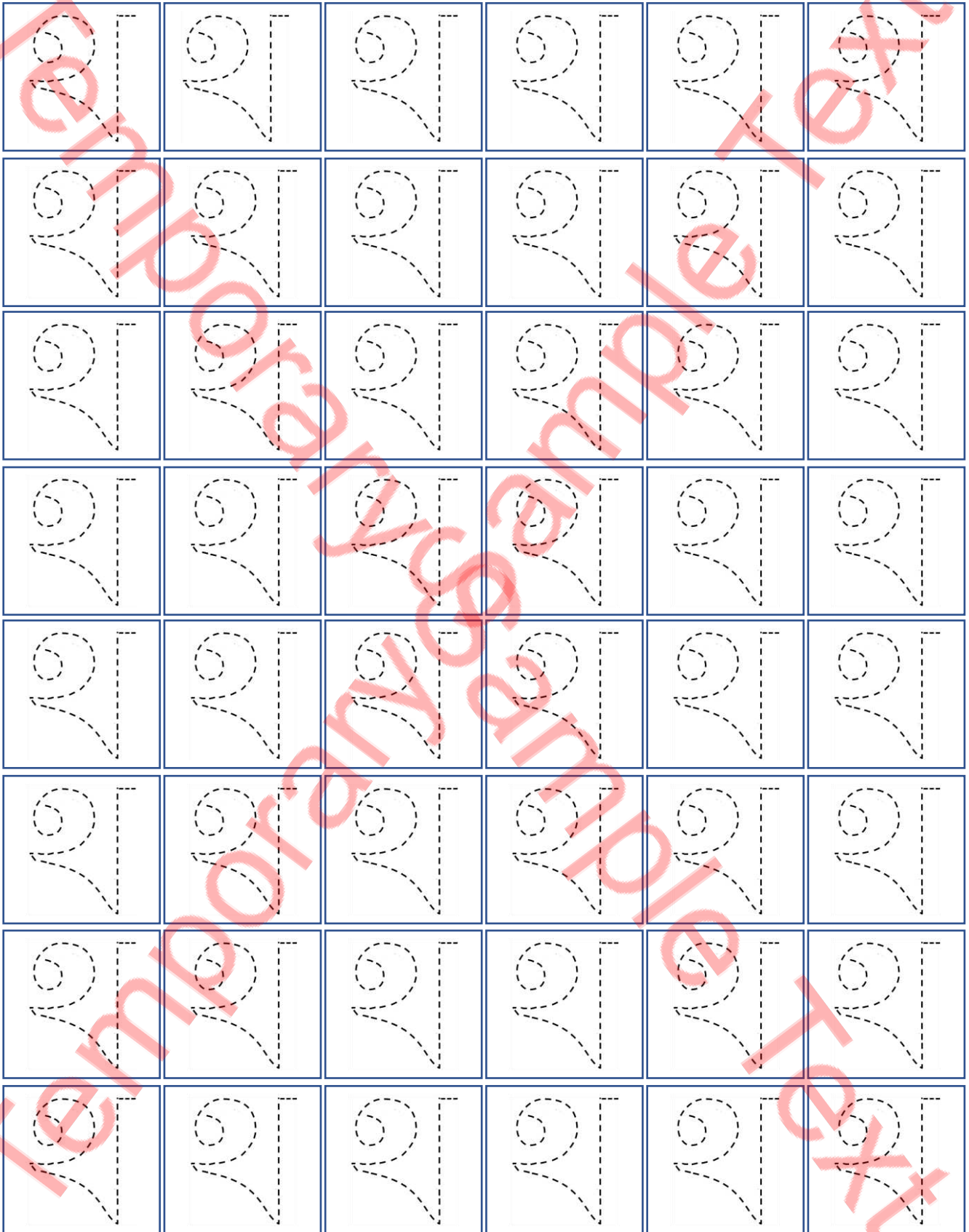

Student Name: _____

Verified By: _____

Class: _____

Date: _____

Write it

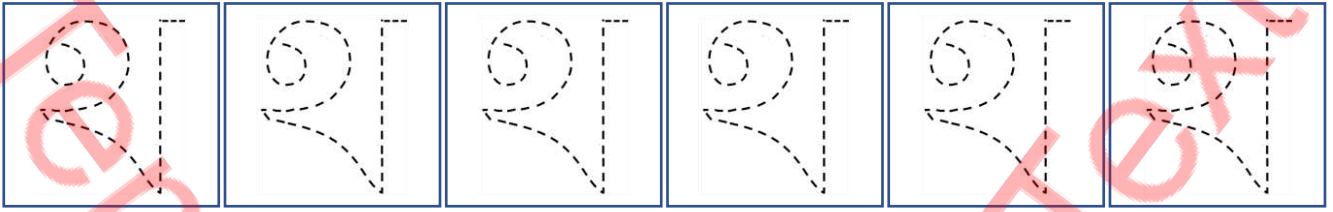

Student Name: _____

Verified By: _____

Class: _____

Date: _____

Copy Colour



Colour it

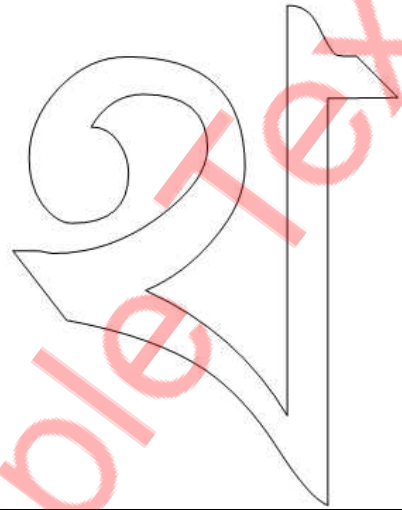

Write it

Find it

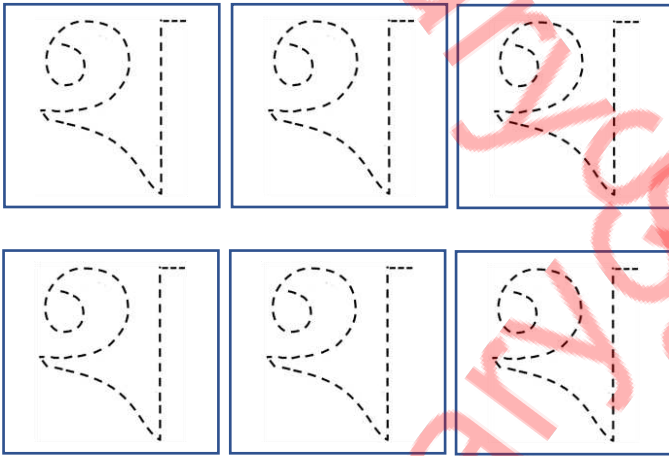

Connect the circle

Do it

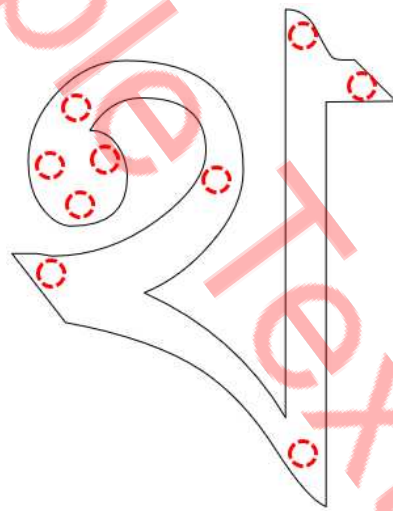
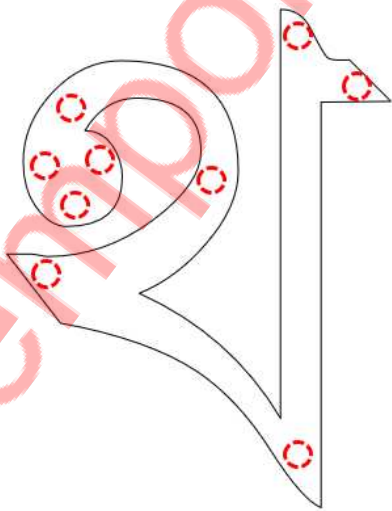

Student Name: _____

Verified By: _____

Class: _____

Date: _____

Pick the Path Find the Correct Alphabet

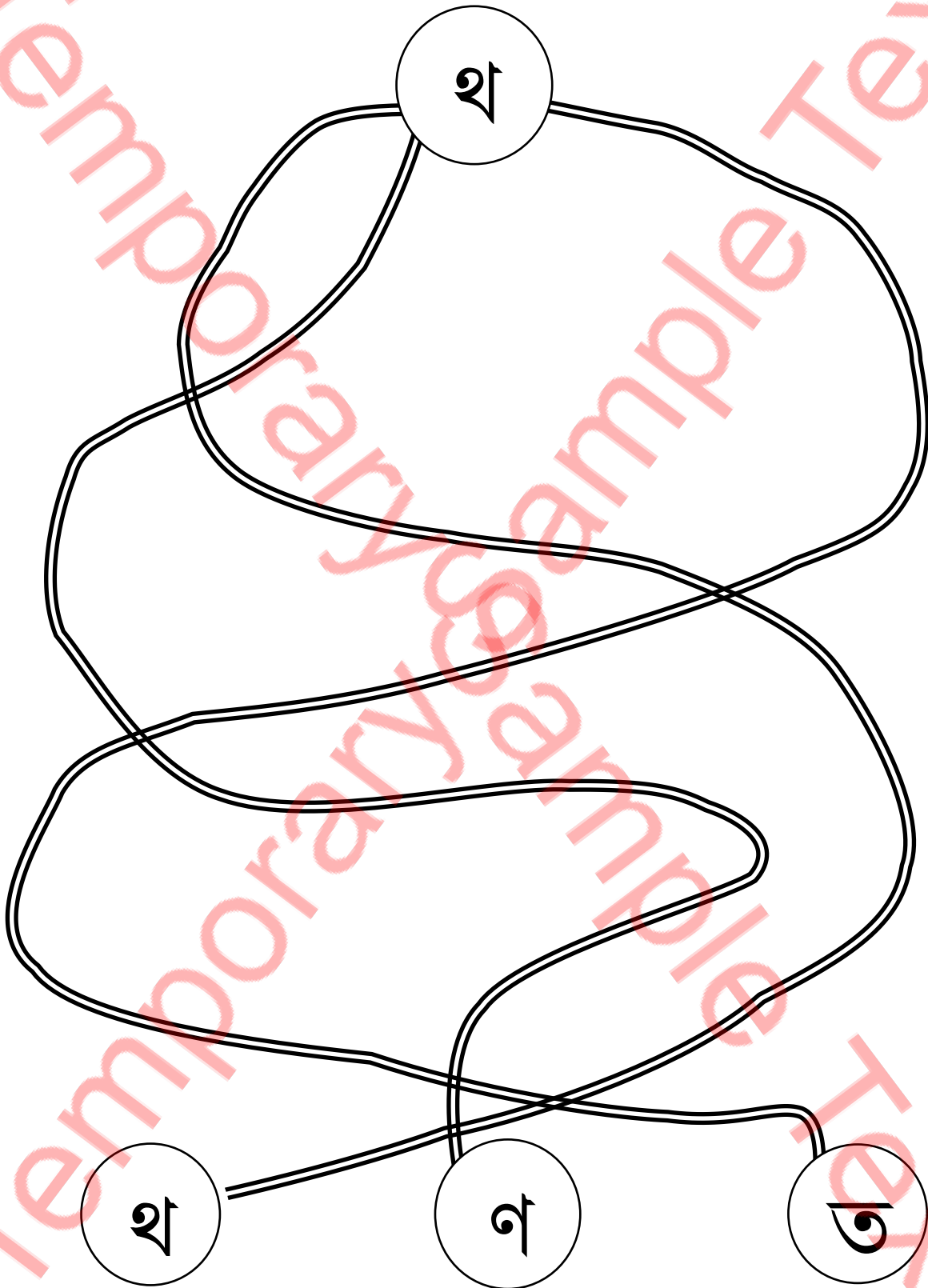

Student Name: _____

Verified By: _____

Class: _____

Date: _____

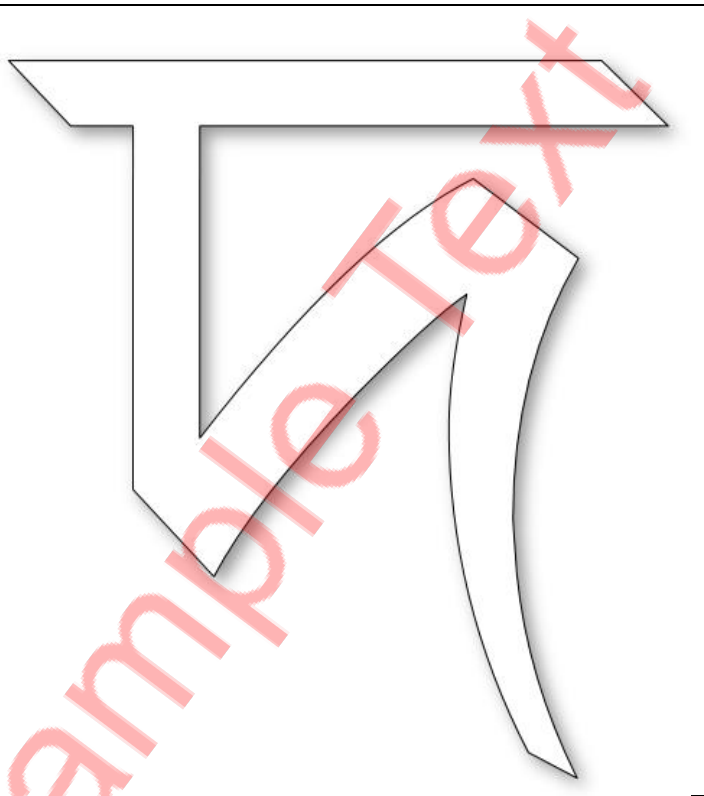
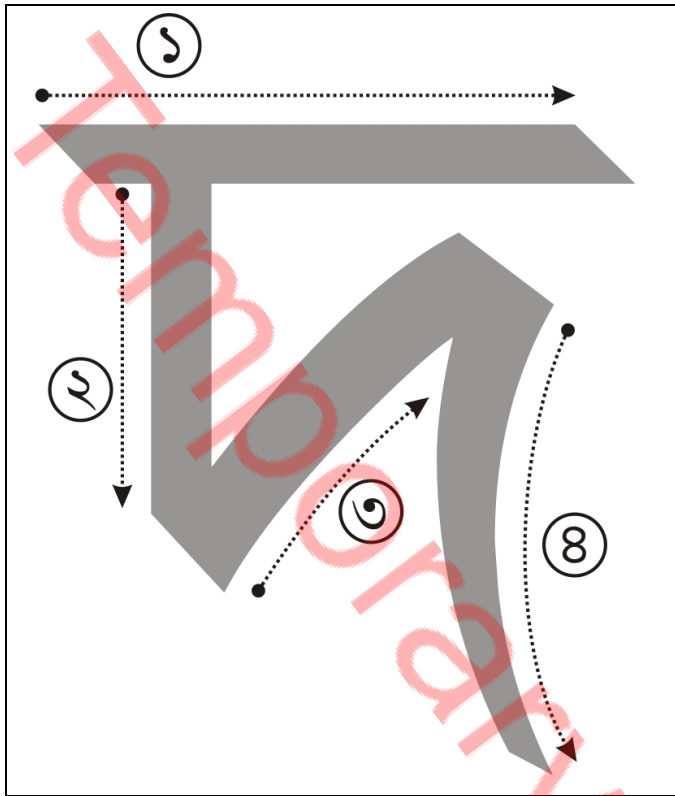

Follow the above steps

Colour it accordingly

ক	খ	গ	ঘ	ঙ	চ	ছ	জ
ঝ	ঞ	ট	ঠ	ড	ঢ	ণ	ত
থ	দ	ধ	ন	প	ফ	ব	ভ
ম	য	র	ল	শ	ষ	স	হ
ড়	ঢ়	য়	ৌ	্	ৎ	৏	

Student Name: _____	Verified By: _____
Class: _____	Date: _____

Trace It



Student Name: _____

Verified By: _____

Class: _____

Date: _____

Trace it

Student Name: _____

Verified By: _____

Class: _____

Date: _____

Write it

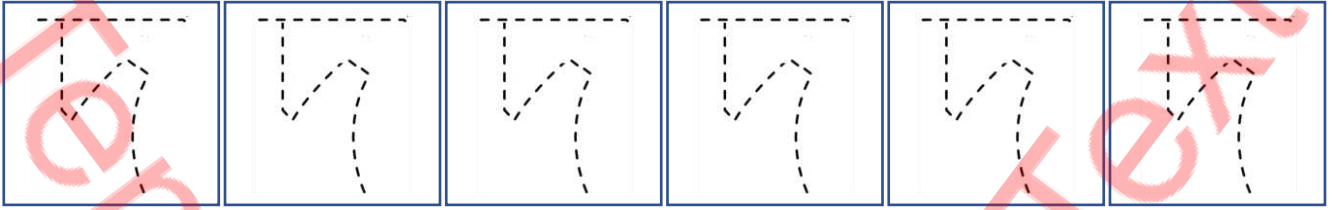

Student Name: _____

Verified By: _____

Class: _____

Date: _____

Copy Colour

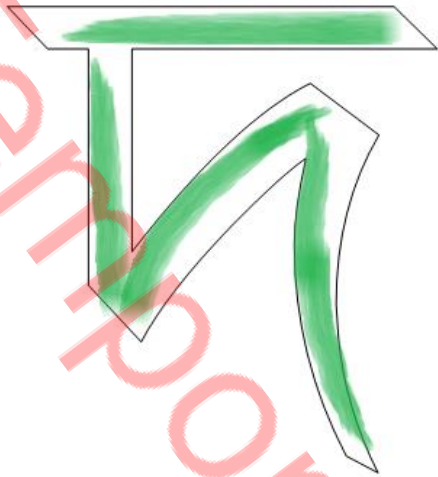

Colour it



Write it

Find it

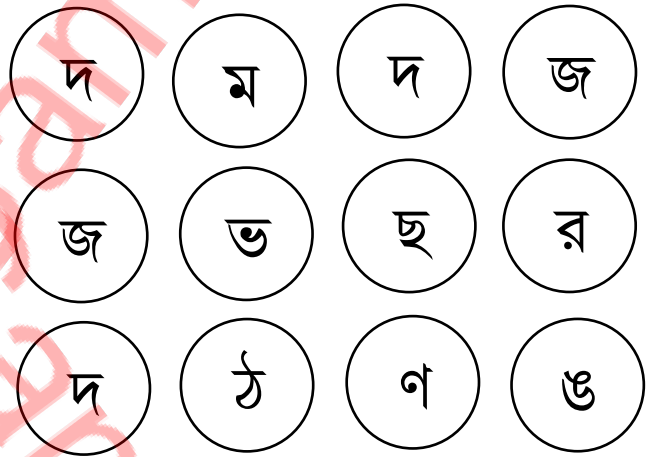
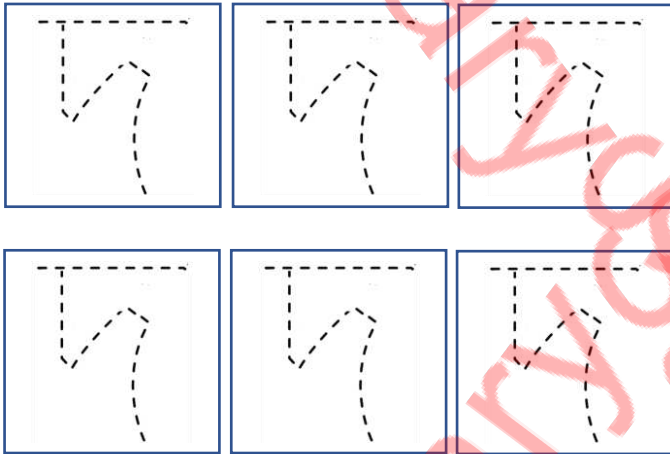

Connect the circle

Do it

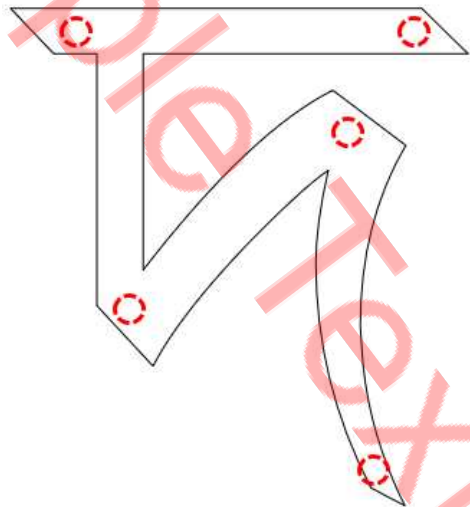
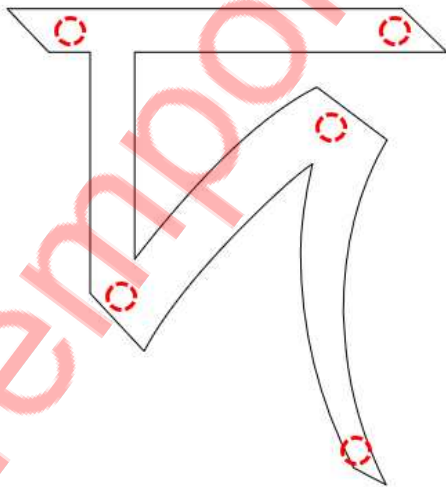

Student Name: _____

Verified By: _____

Class: _____

Date: _____

Pick the Path Find the Correct Alphabet

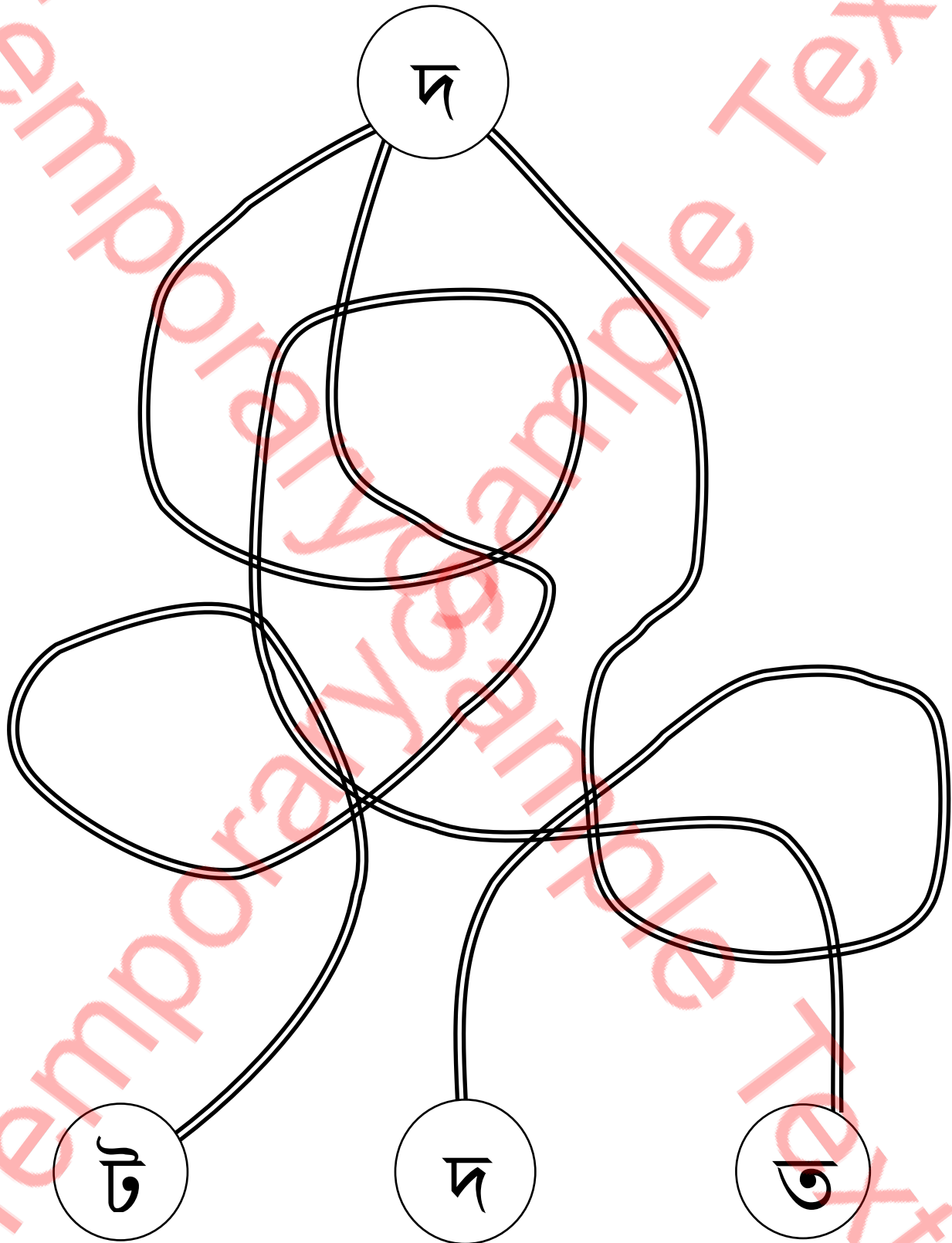

Student Name: _____

Verified By: _____

Class: _____

Date: _____

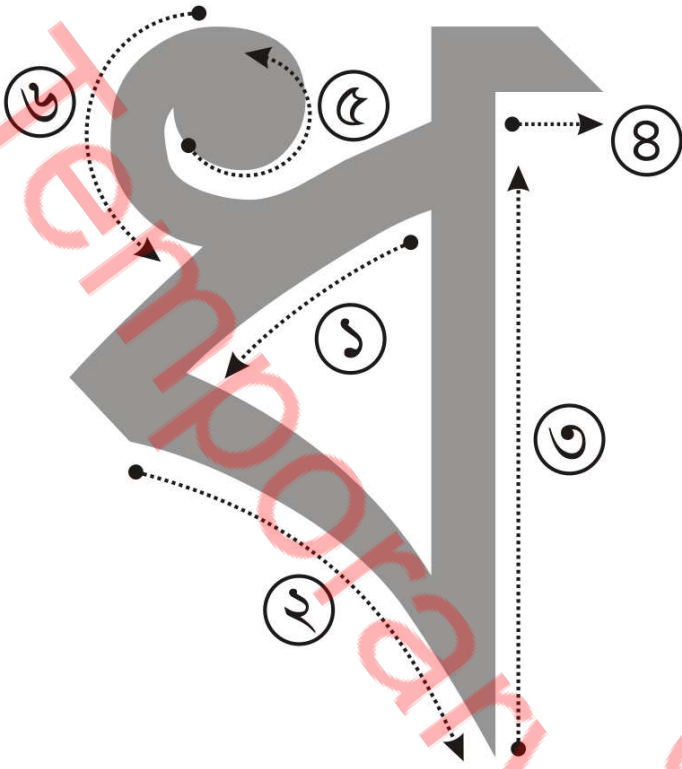

Follow the above steps

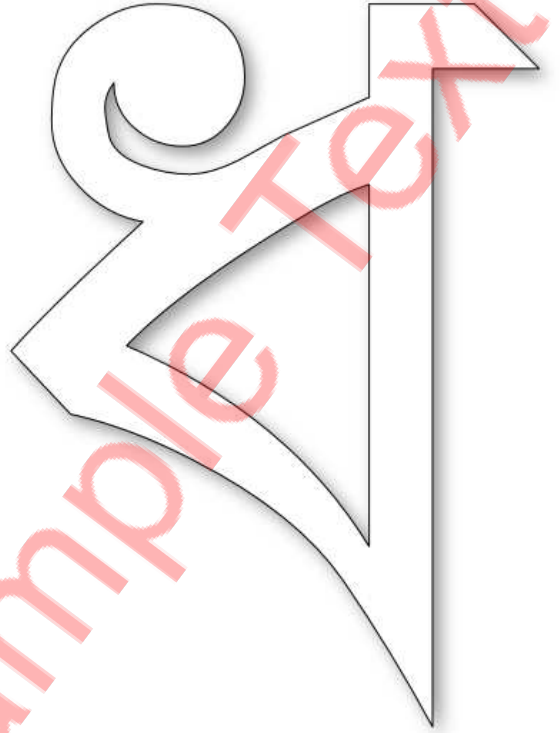

Colour it accordingly

ক	খ	গ	ঘ	ঙ	চ	ছ	জ
ঝ	ঞ	ট	ঠ	ড	ঢ	ণ	ত
থ	দ	ধ	ন	প	ফ	ব	ভ
ম	য	র	ল	শ	ষ	স	হ
ড়	ঢ়	য়	৐	৑	৒	৓	

Student Name: _____

Verified By: _____

Class: _____

Date: _____

Trace It

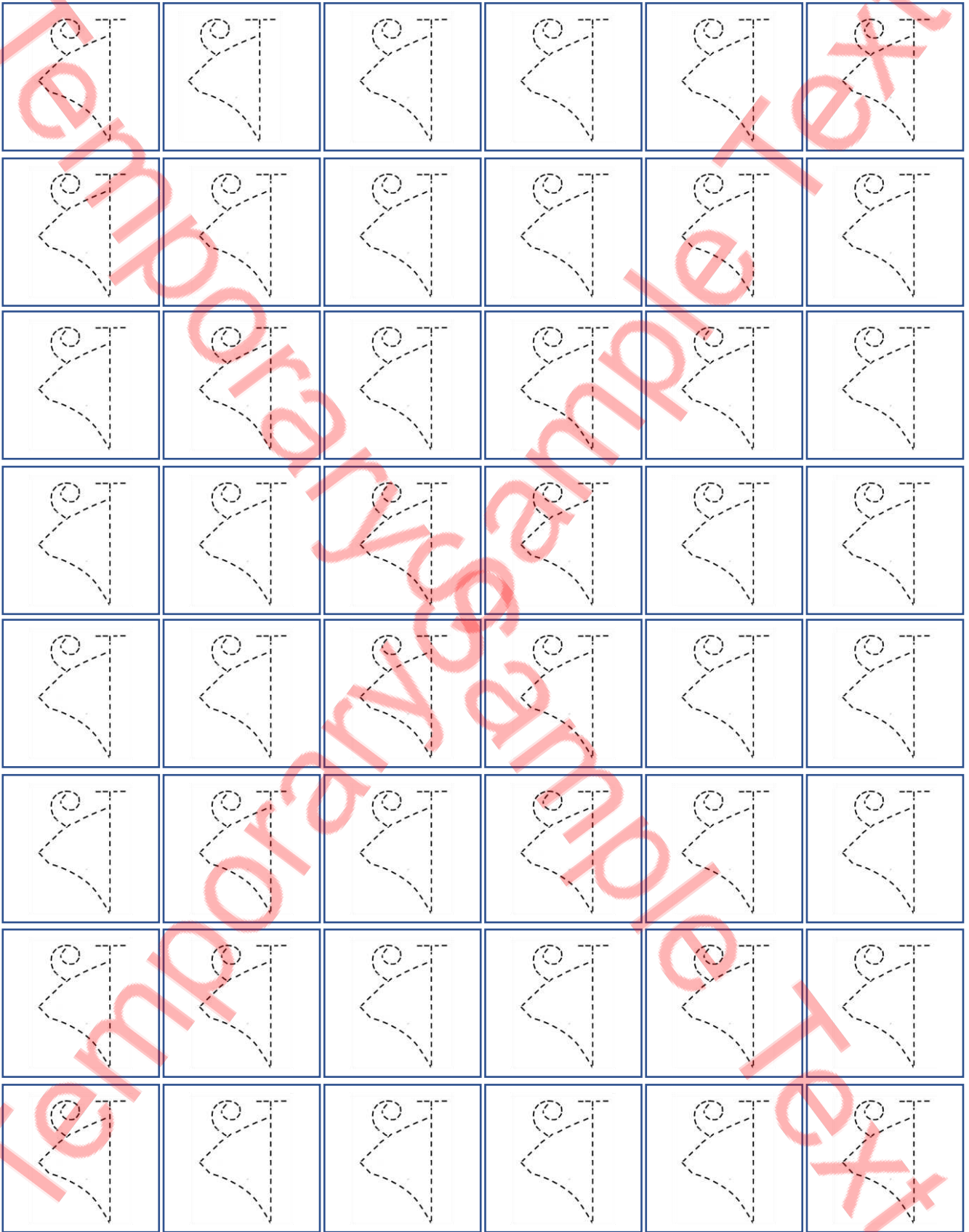

Student Name: _____

Verified By: _____

Class: _____

Date: _____

Trace it

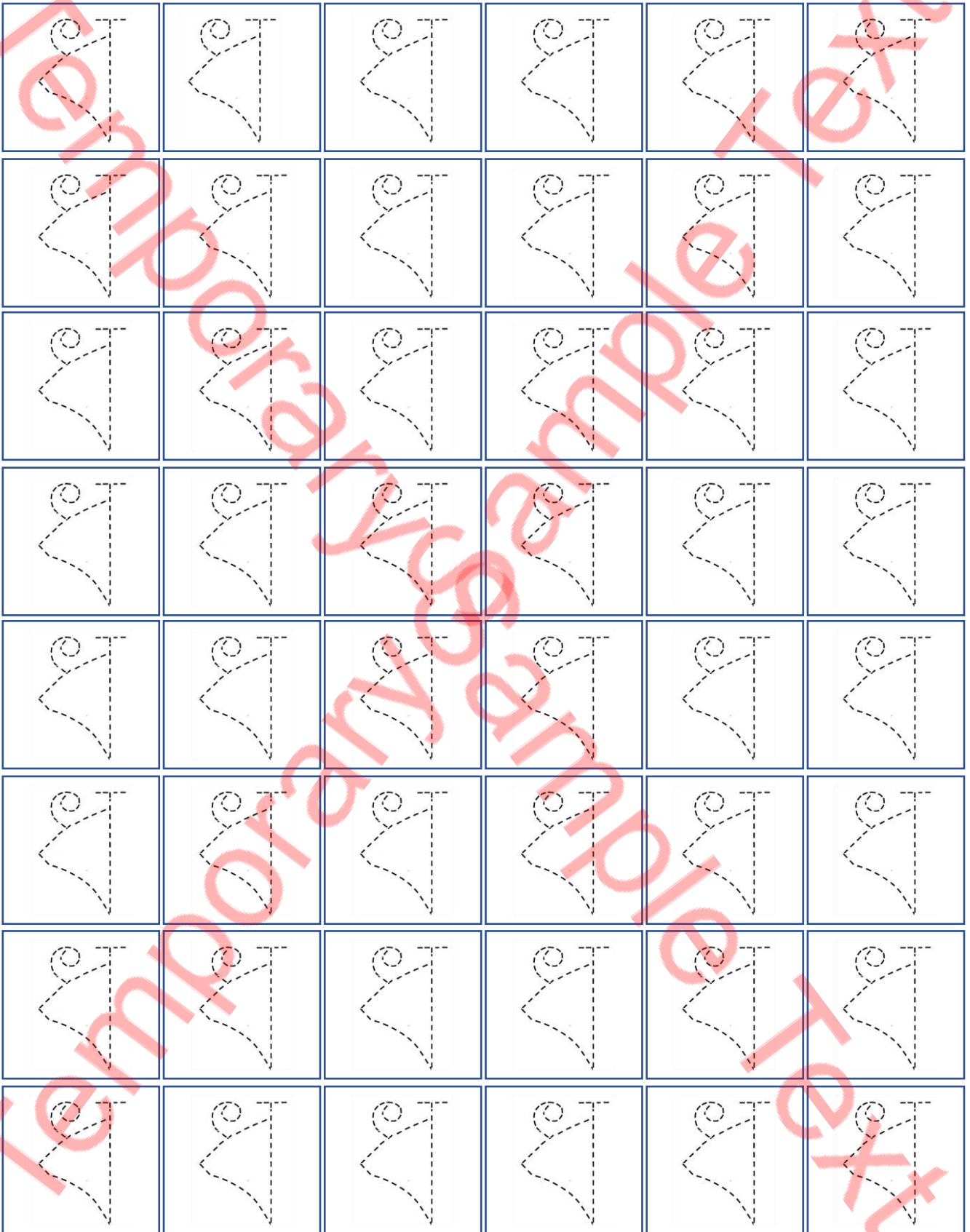

Student Name: _____

Verified By: _____

Class: _____

Date: _____

Write it

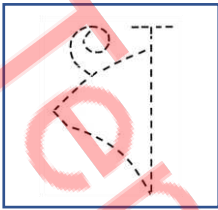
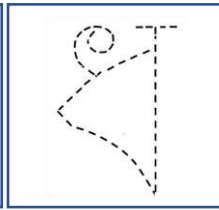
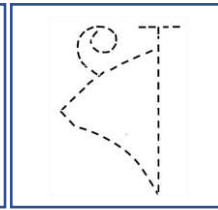
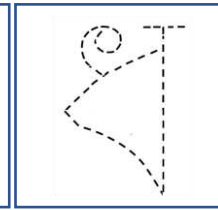
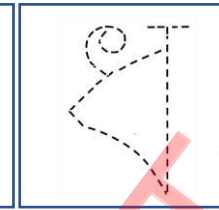
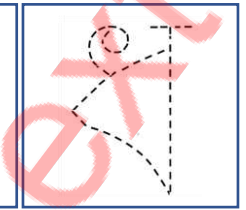
Student Name: _____

Verified By: _____

Class: _____

Date: _____

Copy Colour

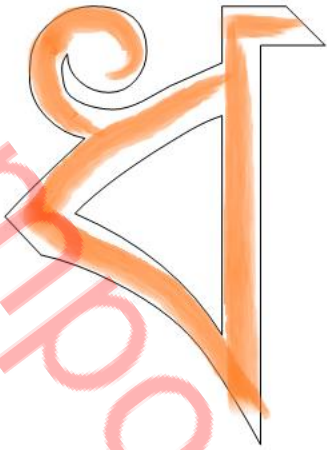

Colour it



Write it

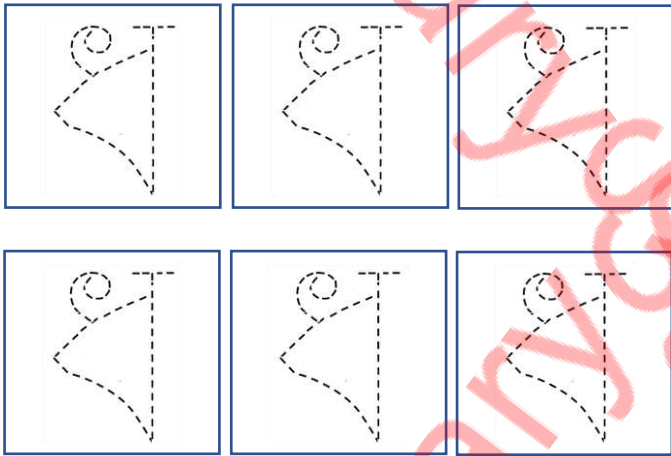

Find it

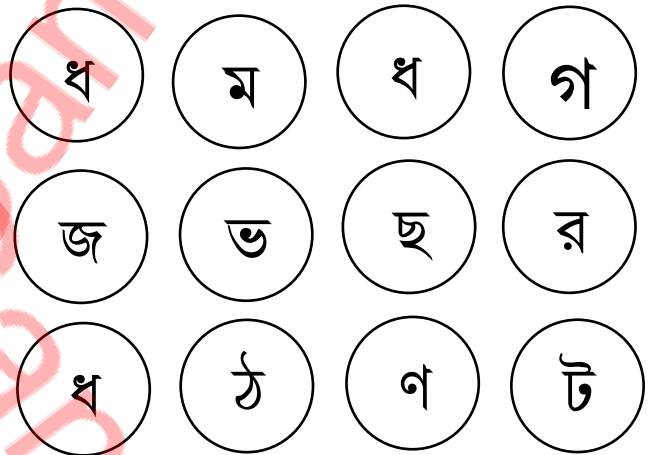

Connect the circle

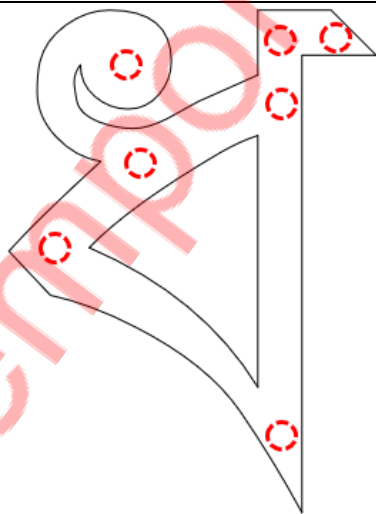

Do it

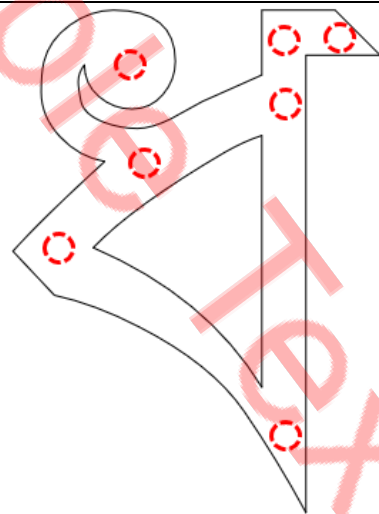

Student Name: _____

Verified By: _____

Class: _____

Date: _____

Pick the Path Find the Correct Alphabet

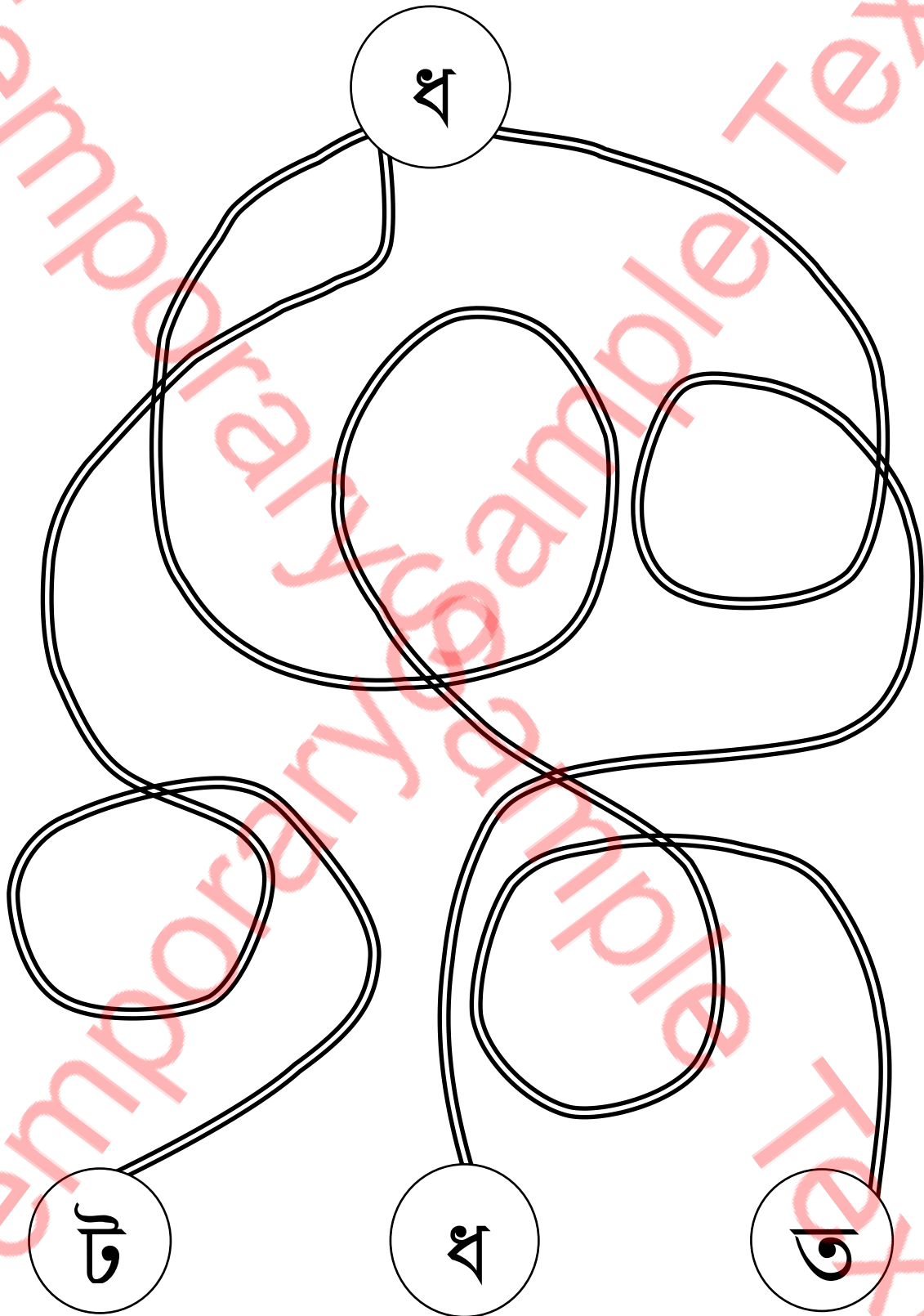

Student Name: _____

Verified By: _____

Class: _____

Date: _____

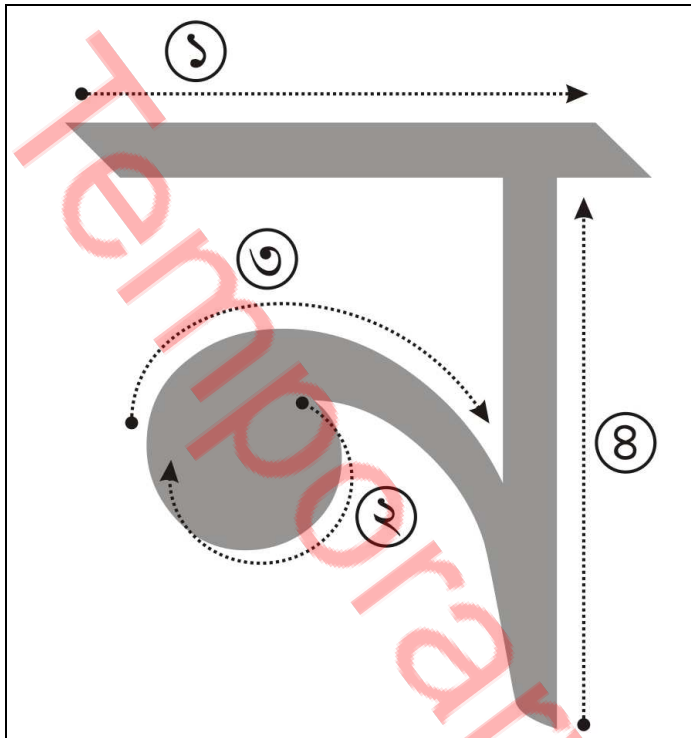

Follow the above steps

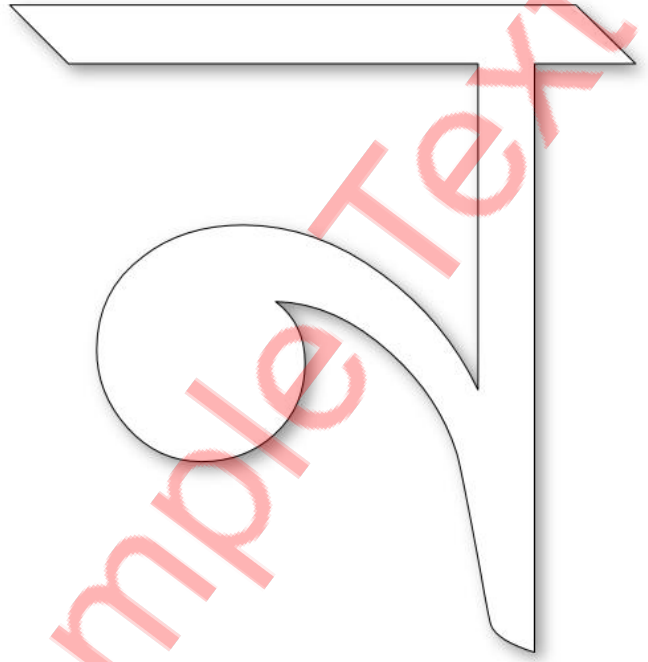

Colour it accordingly

ক	খ	গ	ঘ	ঙ	চ	ছ	জ
ঝ	ঞ	ট	ঠ	ড	ঢ	ণ	ত
থ	দ	ধ	ন	প	ফ	ব	ভ
ম	য	র	ল	শ	ষ	স	হ
ড়	ঢ়	য়	ৎ	ৎ	ঃ	ৎ	

Student Name: _____

Verified By: _____

Class: _____

Date: _____

Trace It

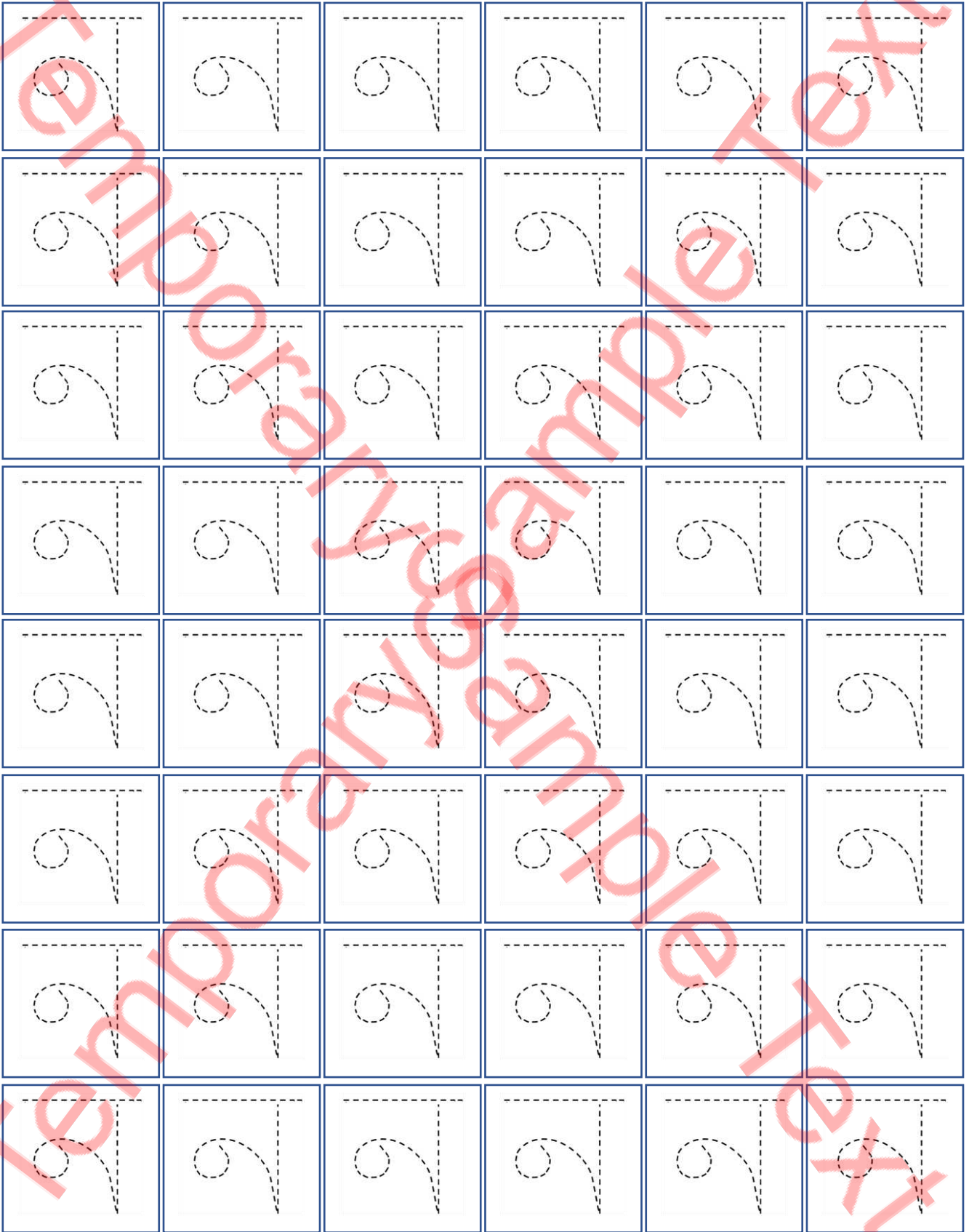

Student Name: _____

Verified By: _____

Class: _____

Date: _____

Trace it

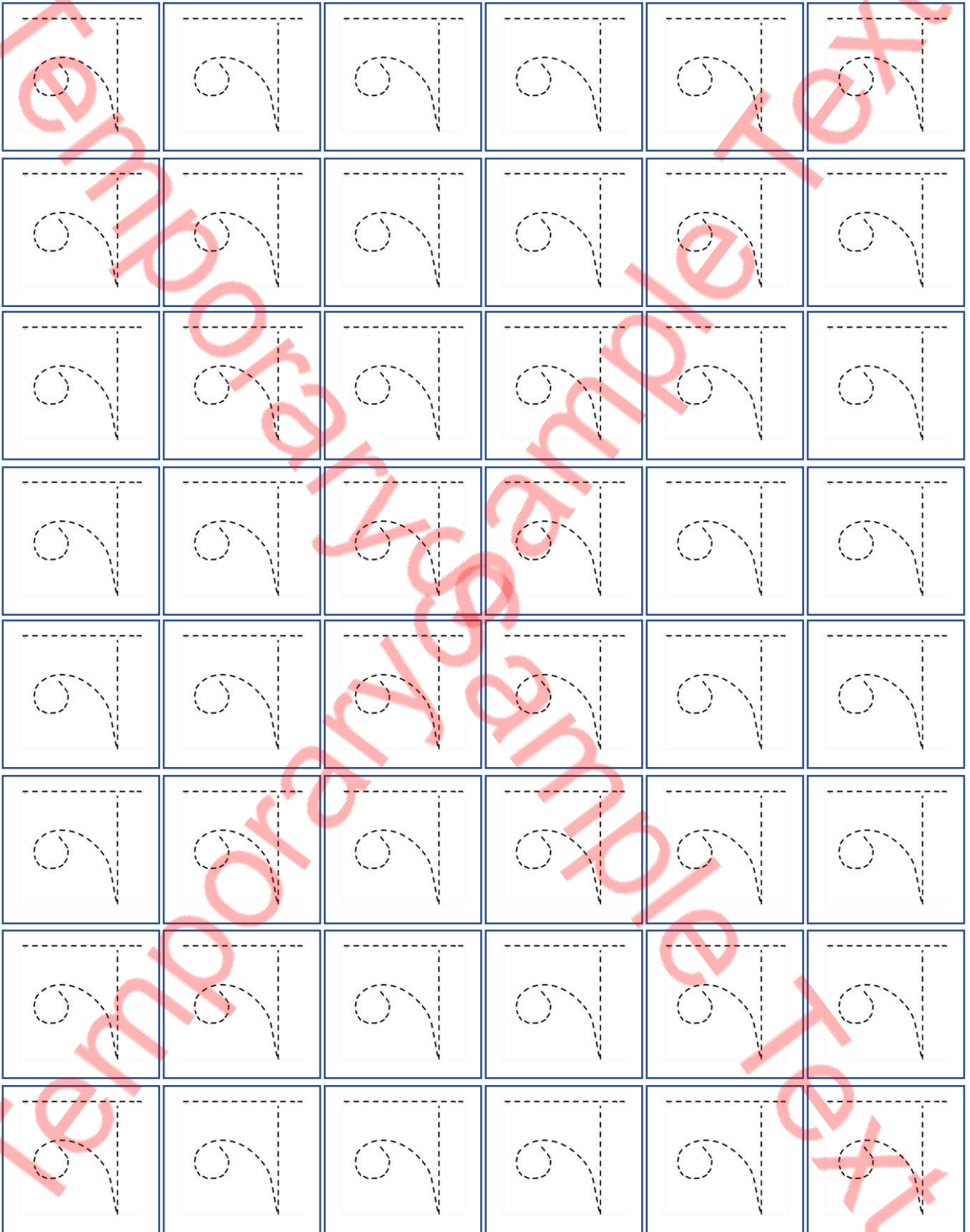

Student Name: _____

Verified By: _____

Class: _____

Date: _____

Write it

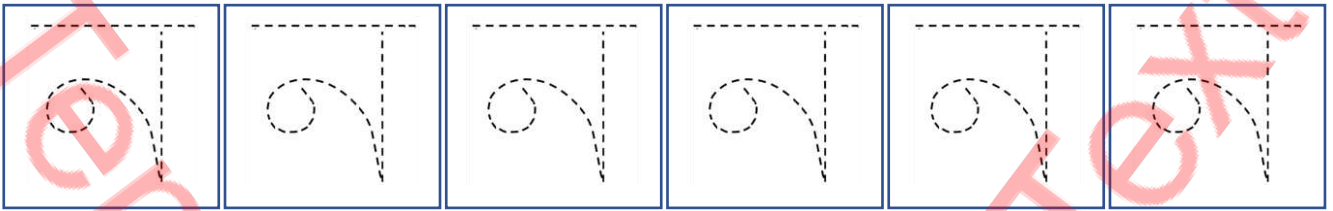

Student Name: _____

Verified By: _____

Class: _____

Date: _____

Copy Colour

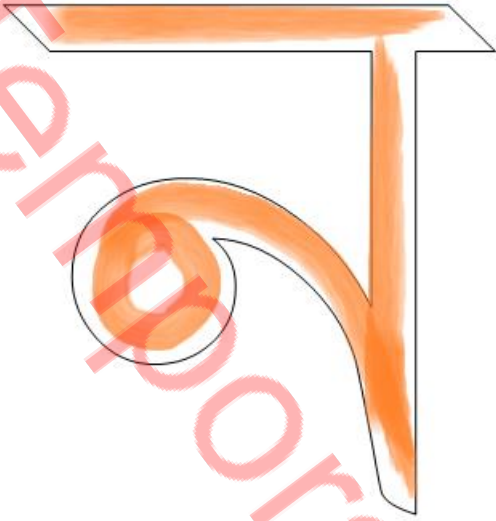

Colour it

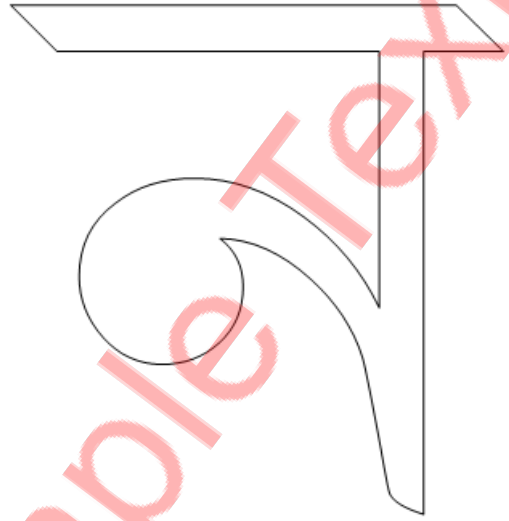

Write it

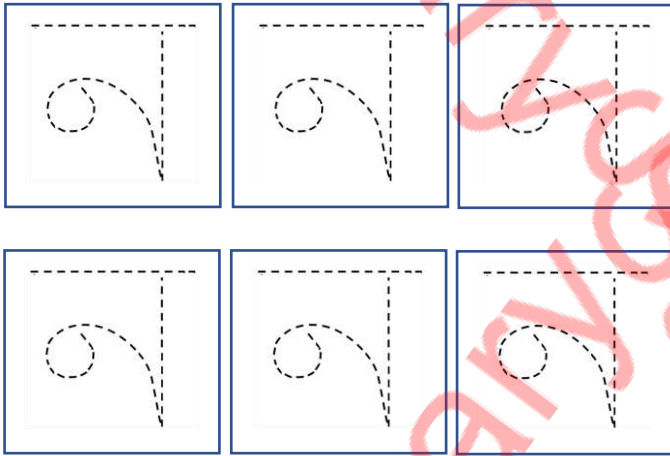

Find it

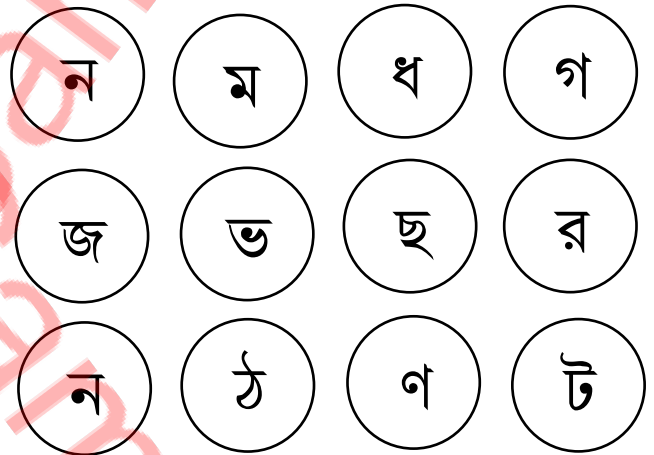

Connect the circle

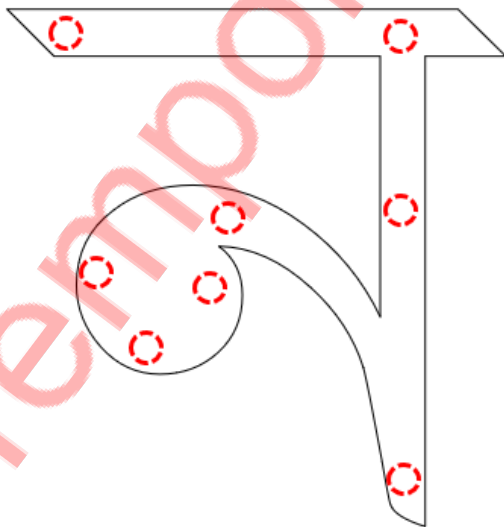

Do it

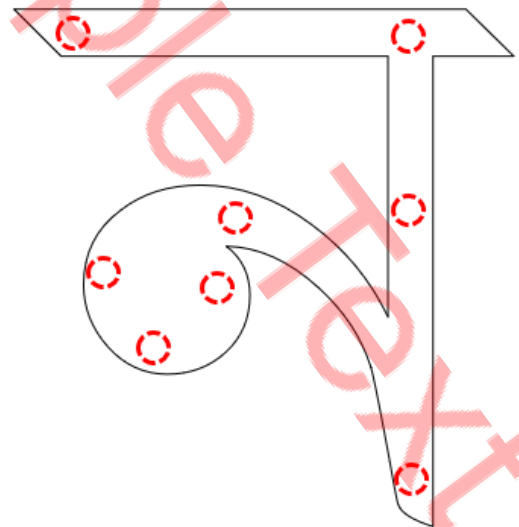

Student Name: _____

Verified By: _____

Class: _____

Date: _____

Pick the Path Find the Correct Alphabet

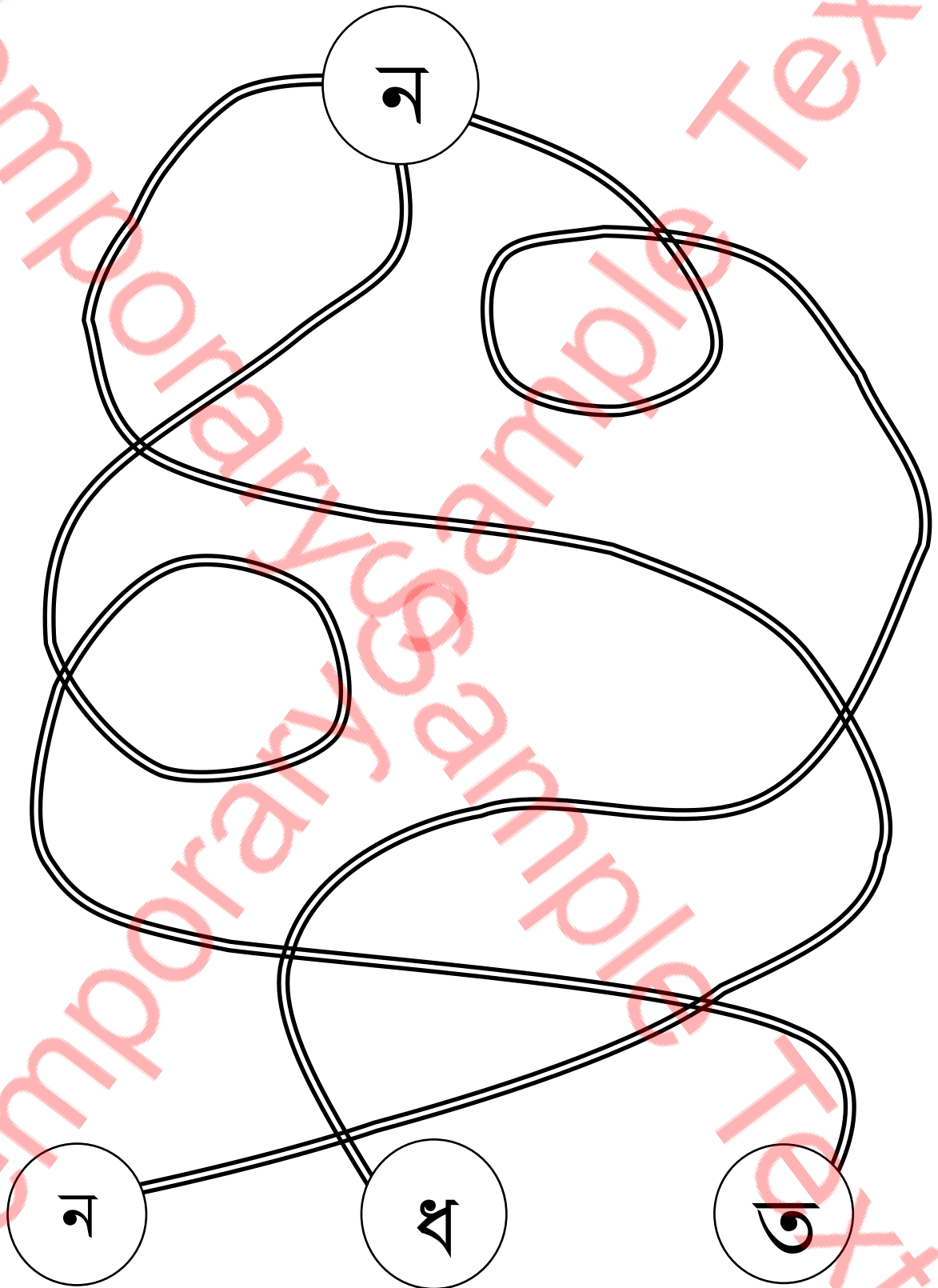

Student Name: _____

Verified By: _____

Class: _____

Date: _____

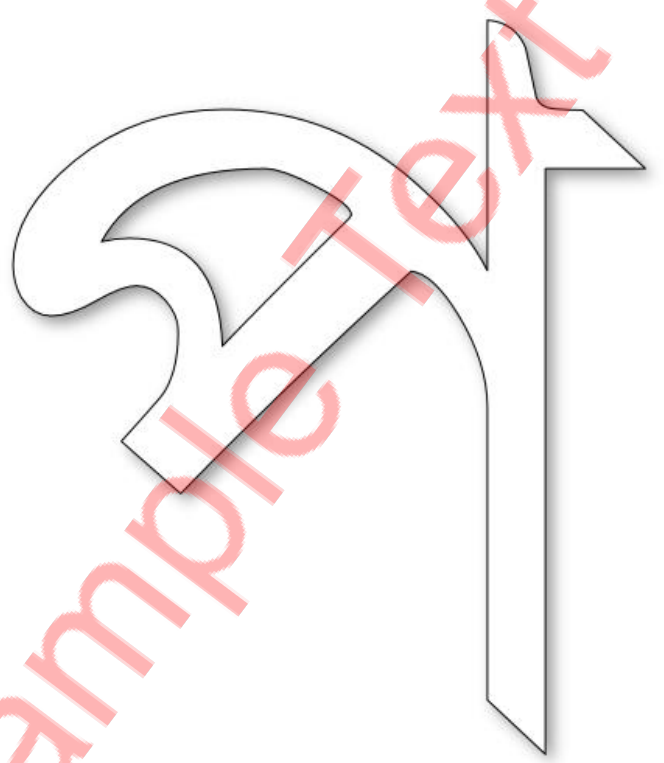
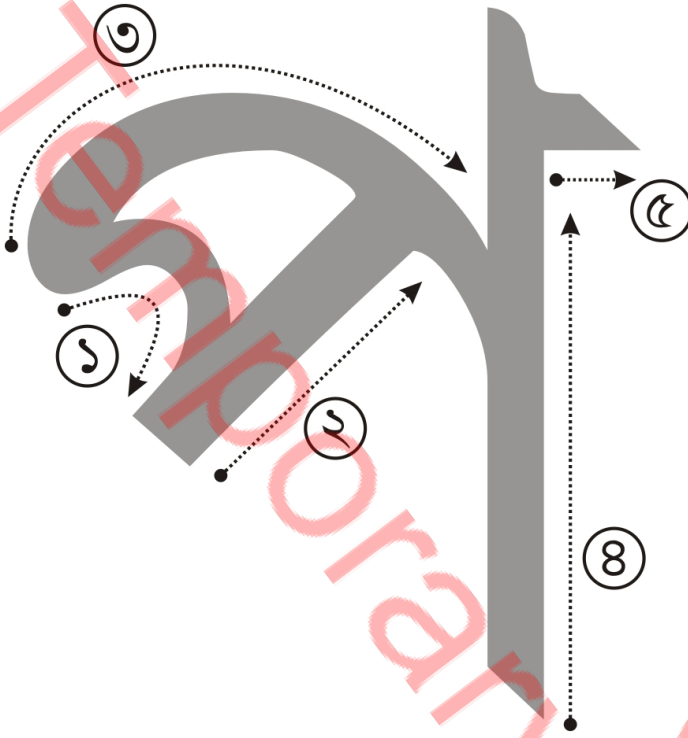

Follow the above steps

Colour it accordingly

ক	খ	গ	ঘ	ঙ	চ	ছ	জ
ঝ	ঞ	ট	ঠ	ড	ঢ	ণ	ত
থ	দ	ধ	ন	প	ফ	ব	ভ
ম	য	র	ল	শ	ষ	স	হ
ড়	ঢ়	য়	ৱ	৲	৳	৴	

Student Name: _____

Verified By: _____

Class: _____

Date: _____

Trace It

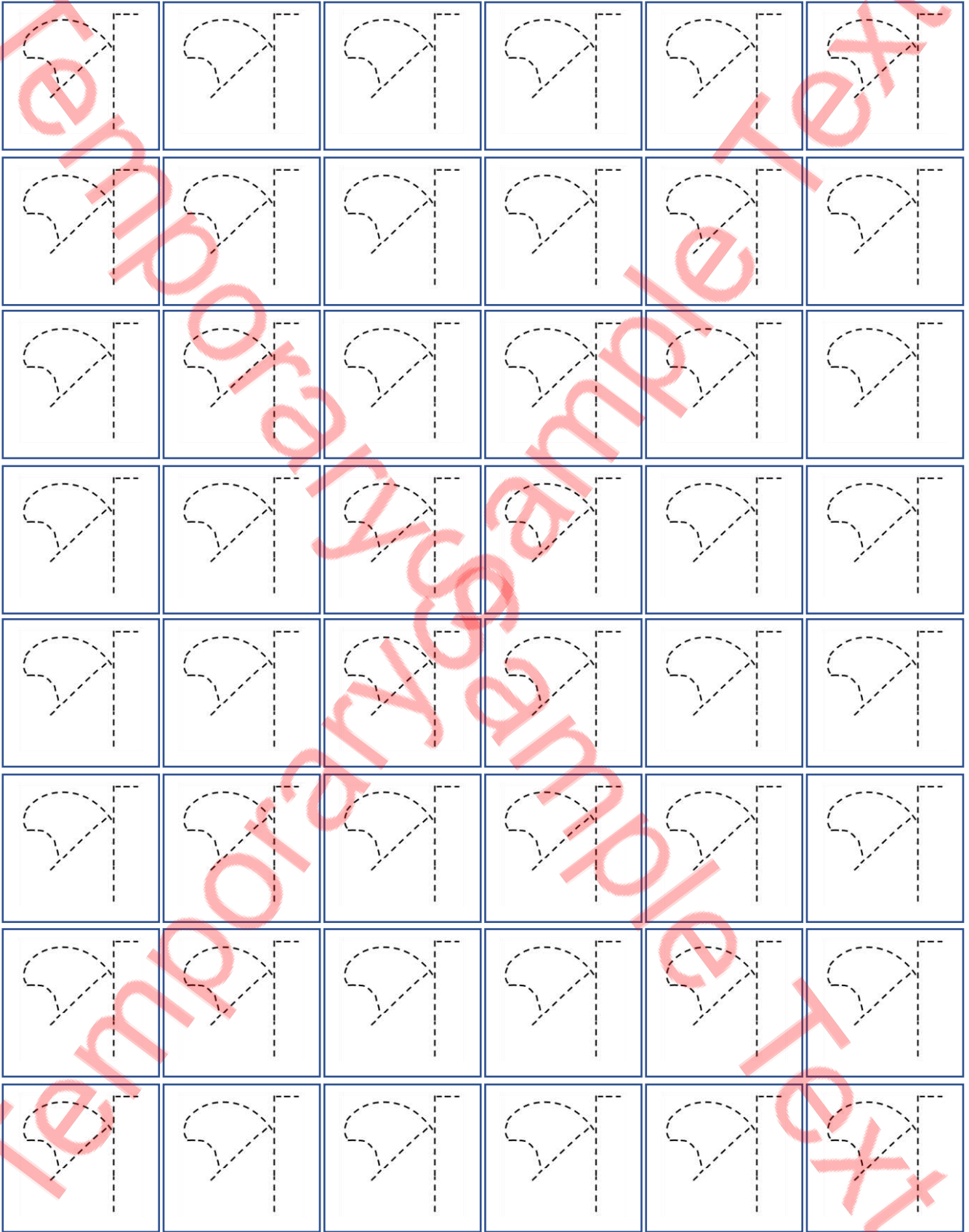

Student Name: _____

Verified By: _____

Class: _____

Date: _____

Trace it

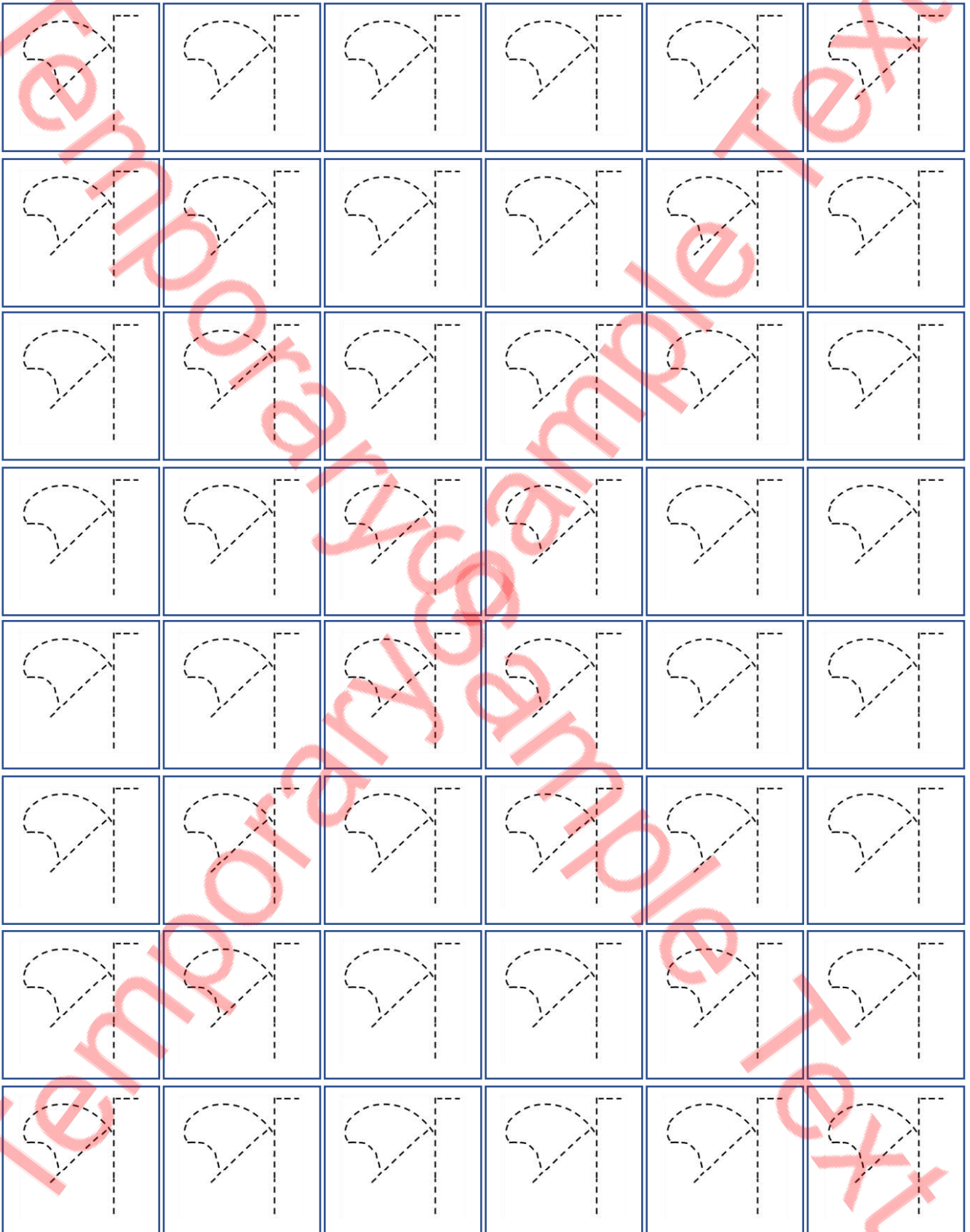

Student Name: _____

Verified By: _____

Class: _____

Date: _____

Write it

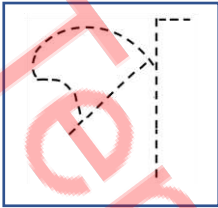
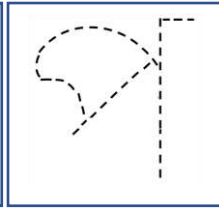
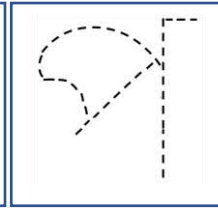
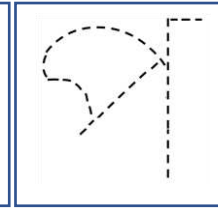
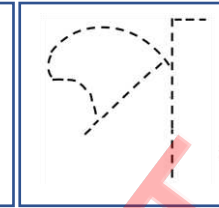
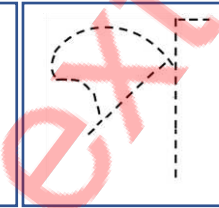
Student Name: _____

Verified By: _____

Class: _____

Date: _____

Copy Colour

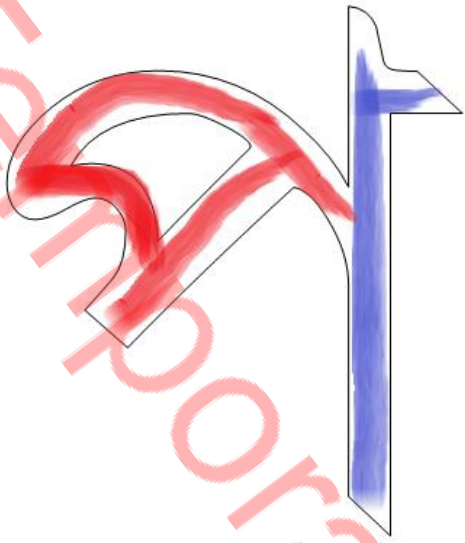

Colour it

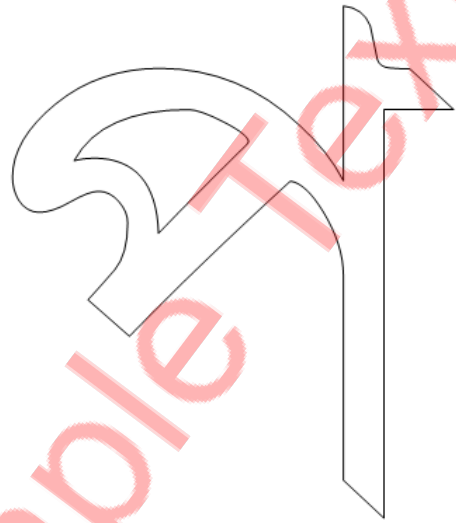

Write it

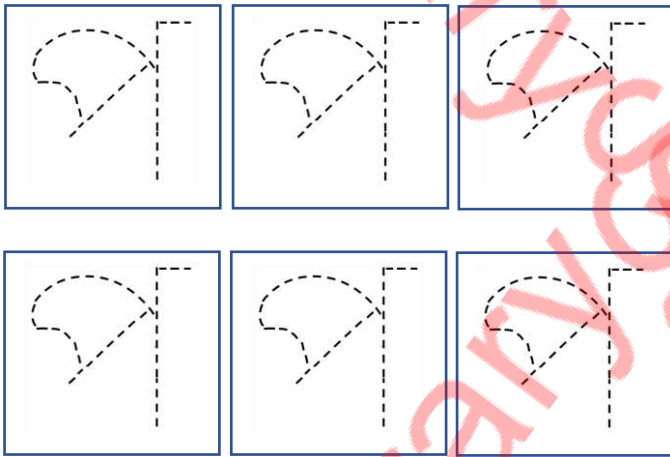

Find it

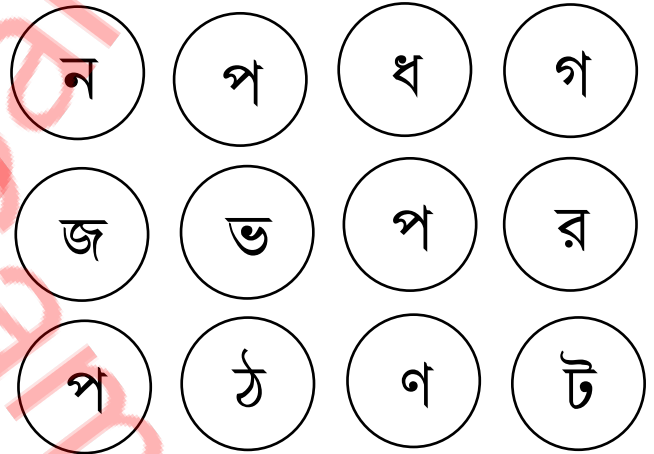

Connect the circle

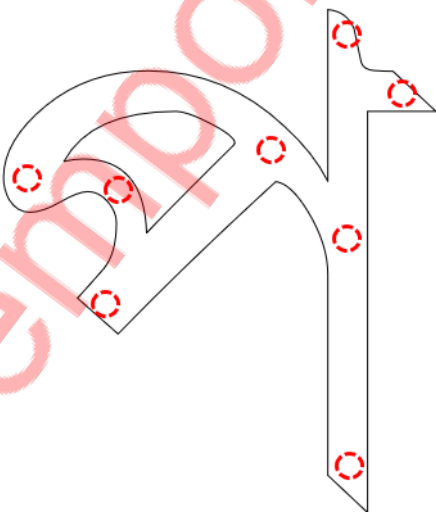

Do it

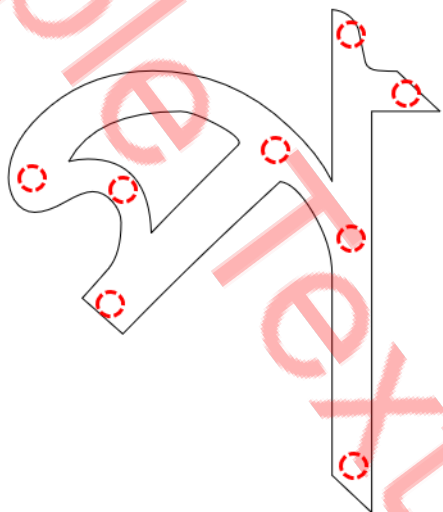

Student Name: _____

Verified By: _____

Class: _____

Date: _____

Pick the Path Find the Correct Alphabet

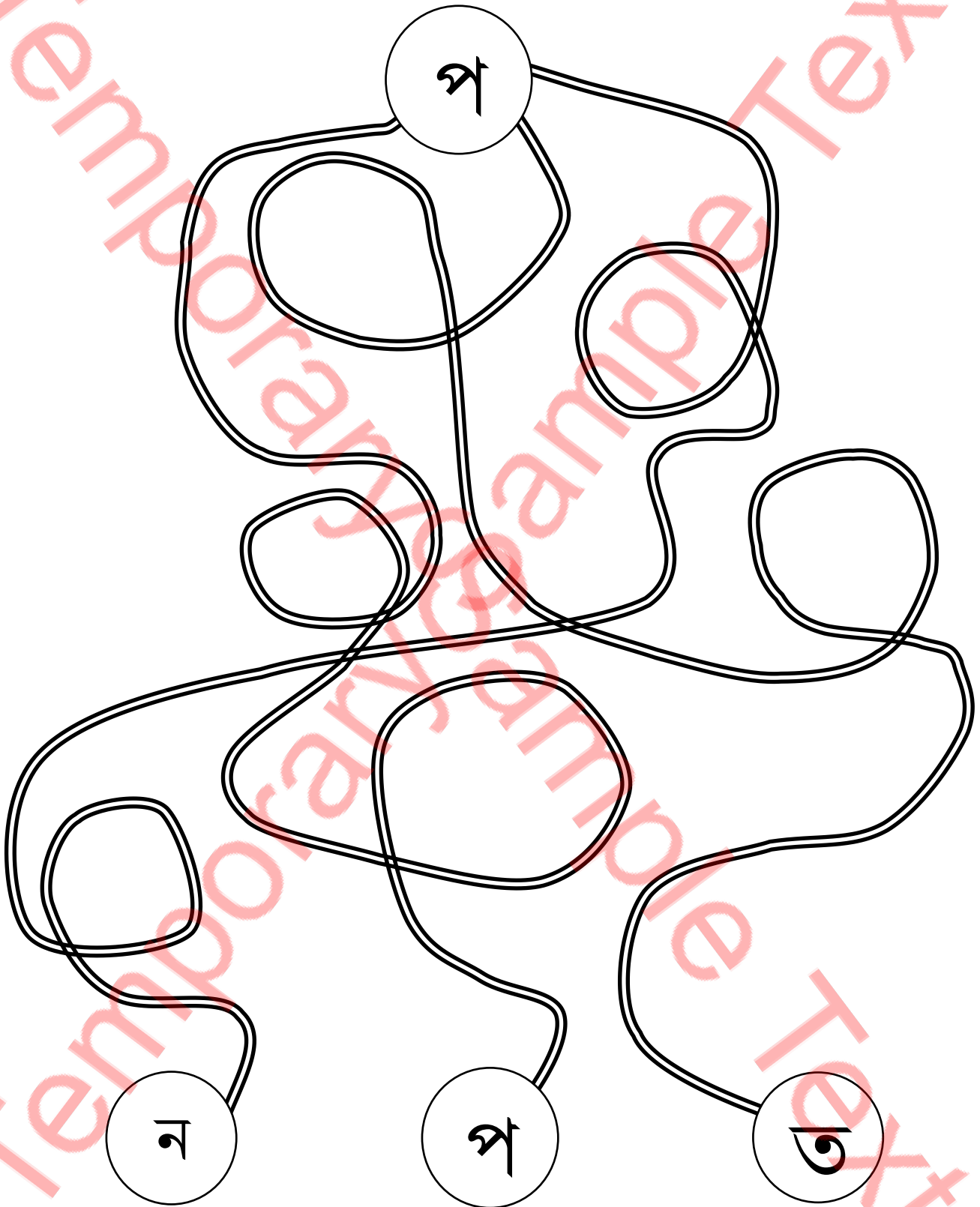

Student Name: _____

Verified By: _____

Class: _____

Date: _____

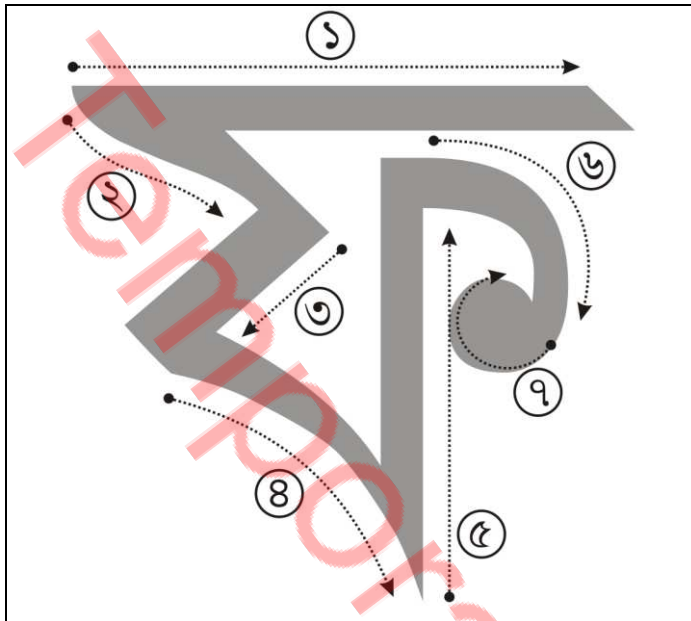

Follow the above steps

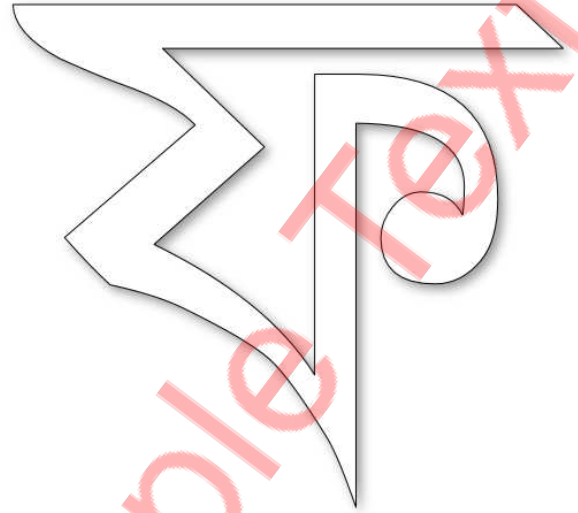

Colour it accordingly

ক	খ	গ	ঘ	ঙ	চ	ছ	জ
ঝ	ঞ	ট	ঠ	ড	ঢ	ণ	ত
থ	দ	ধ	ন	প	ফ	ব	ভ
ম	য	র	ল	শ	ষ	স	হ
ড়	ঢ়	য়	ৌ	্	ৎ	৏	

Student Name: _____

Verified By: _____

Class: _____

Date: _____

Trace It

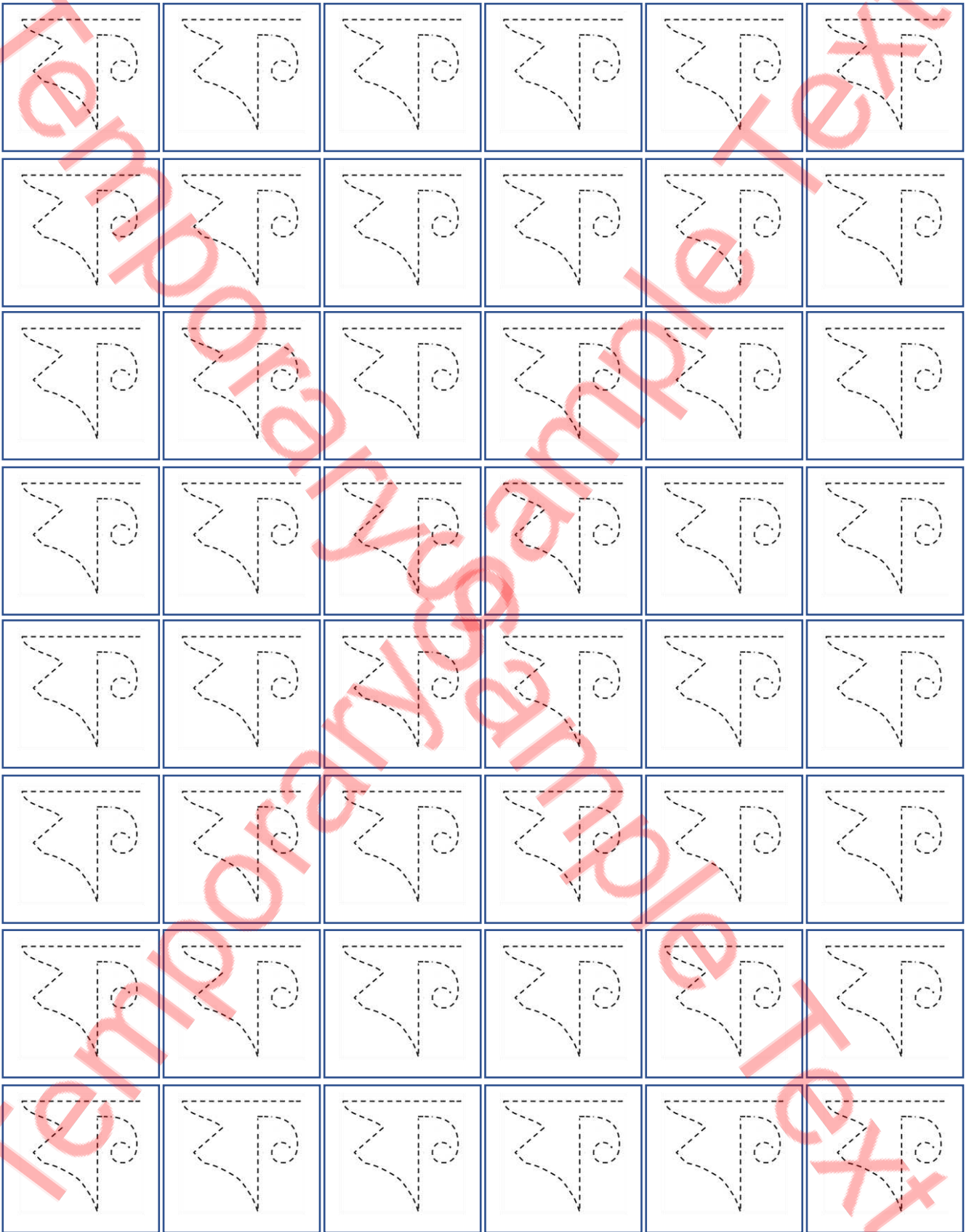

Student Name: _____

Verified By: _____

Class: _____

Date: _____

Trace it

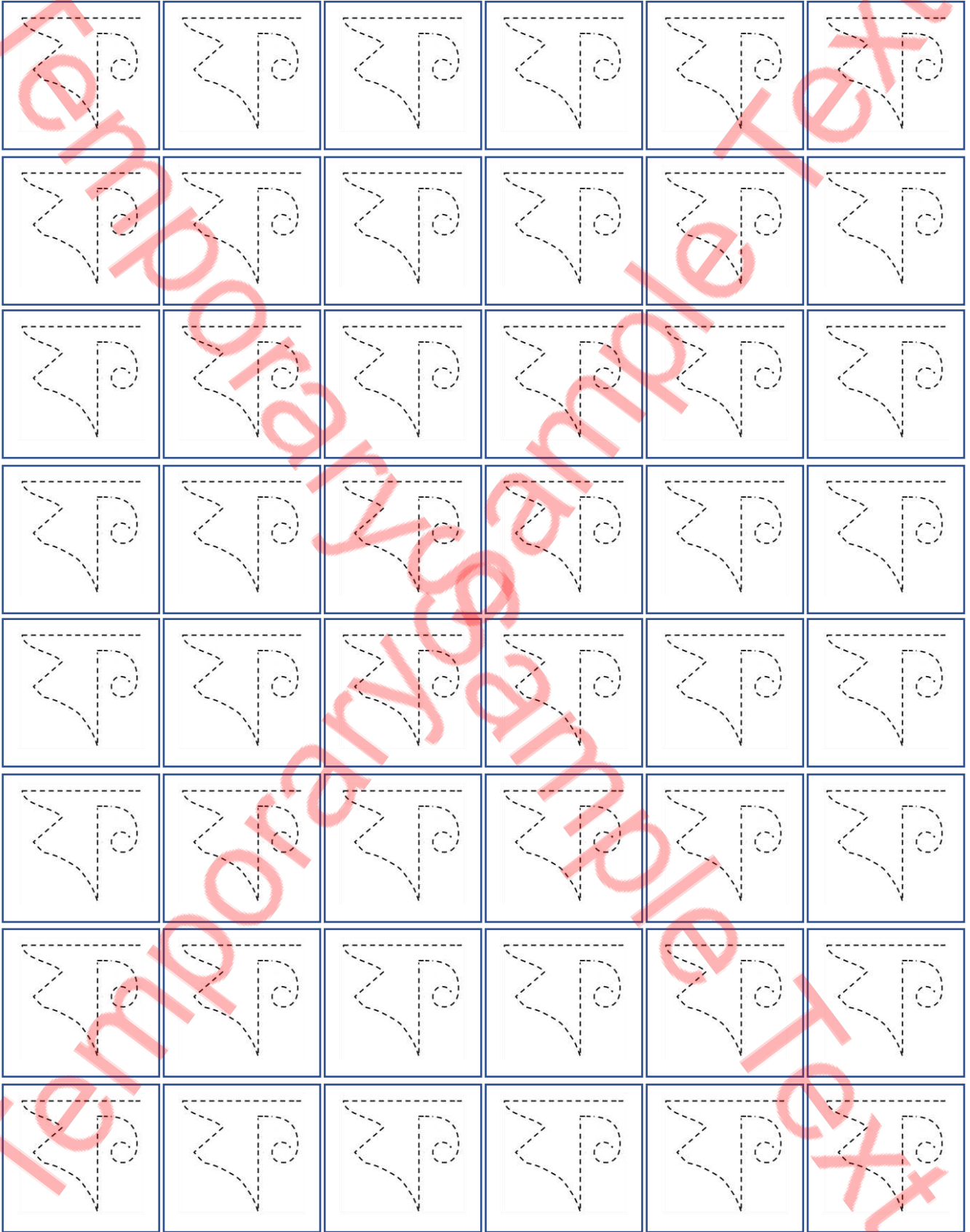

Student Name: _____

Verified By: _____

Class: _____

Date: _____

Write it

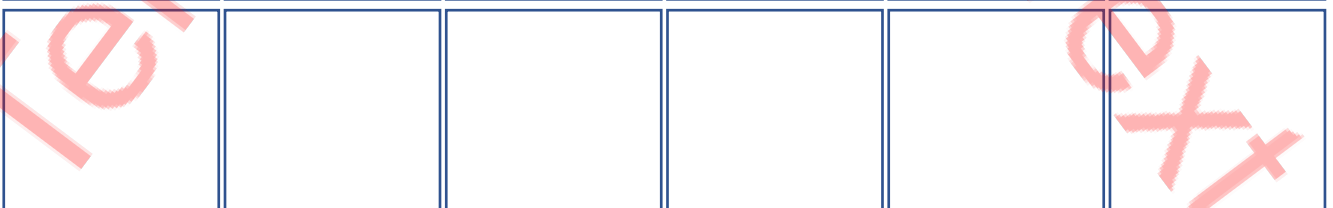
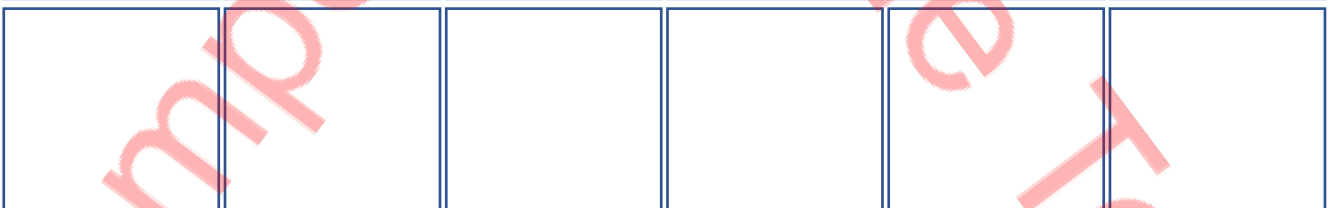
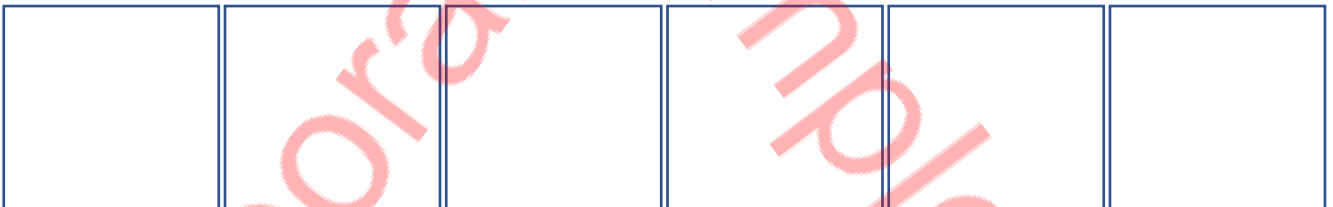
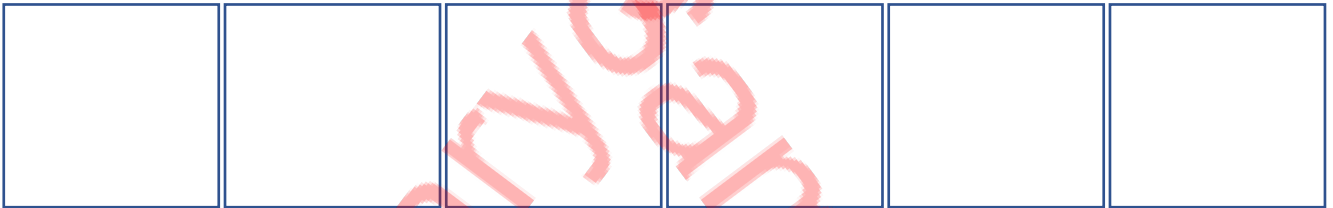
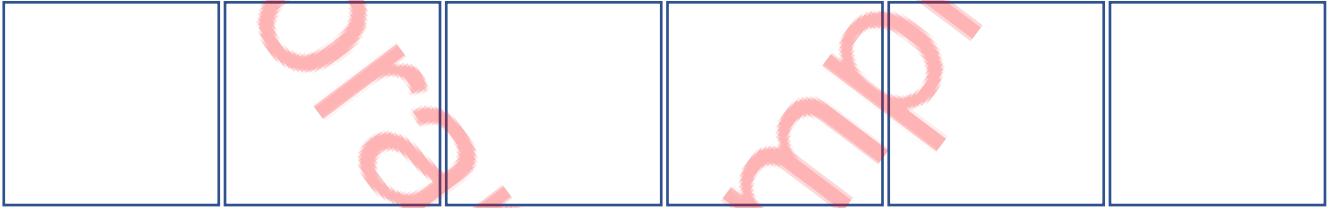
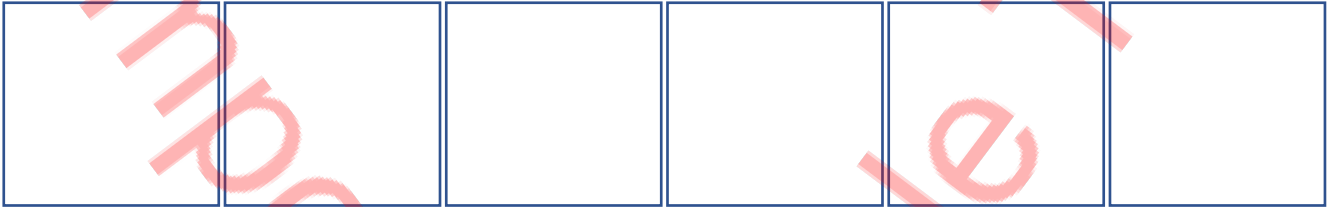
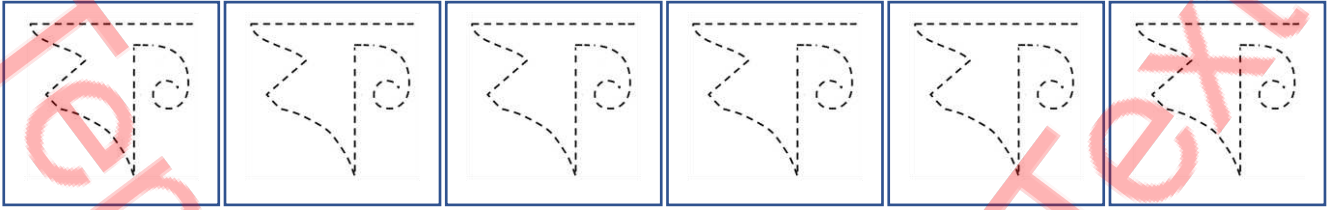

Student Name: _____

Verified By: _____

Class: _____

Date: _____

Copy Colour

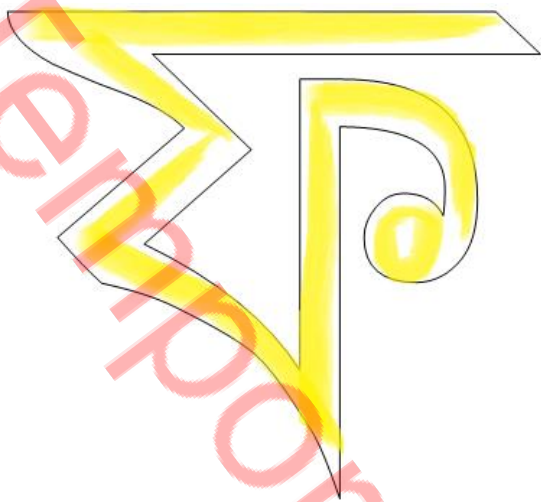

Colour it

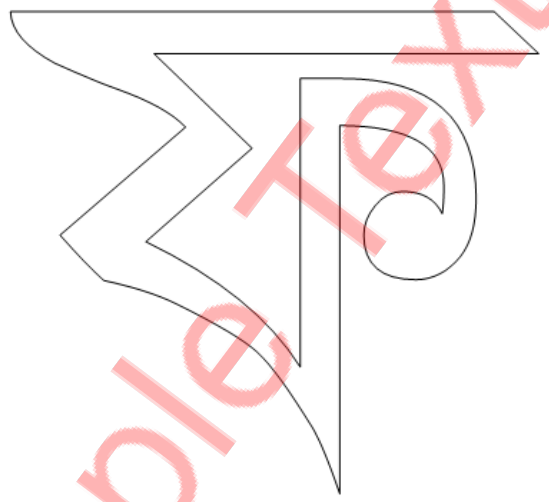

Write it

Find it

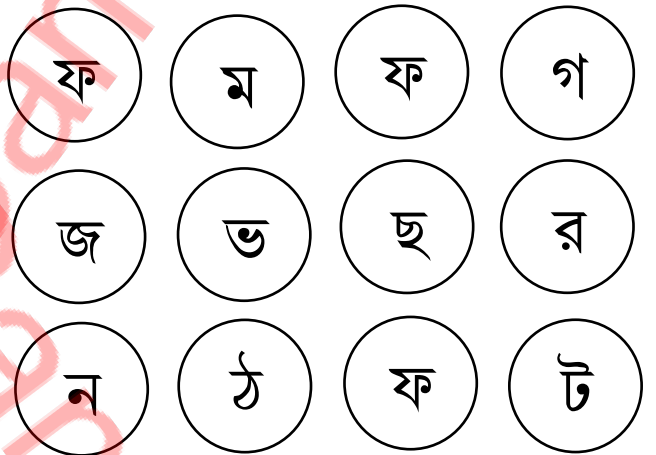
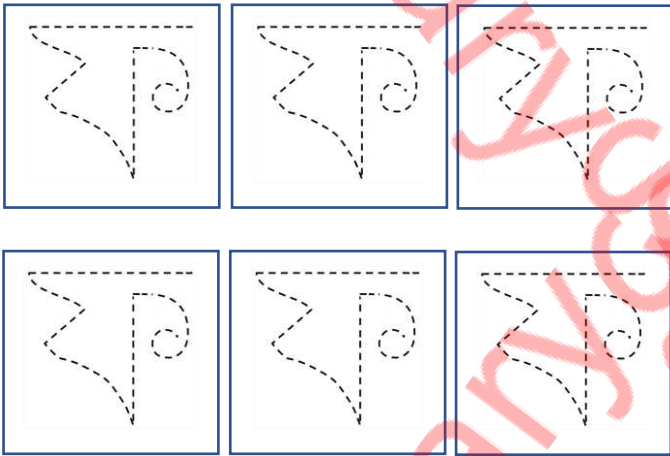

Connect the circle

Do it

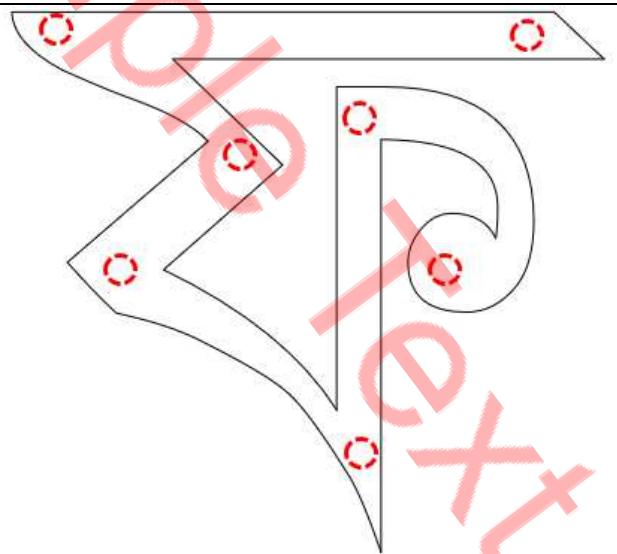
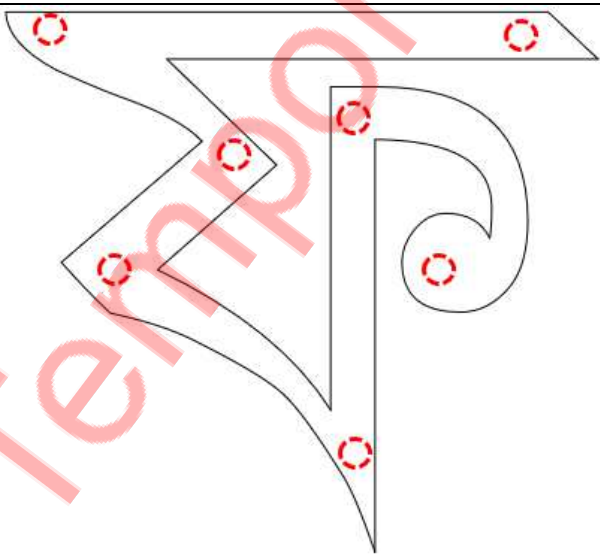

Student Name: _____

Verified By: _____

Class: _____

Date: _____

Pick the Path Find the Correct Alphabet

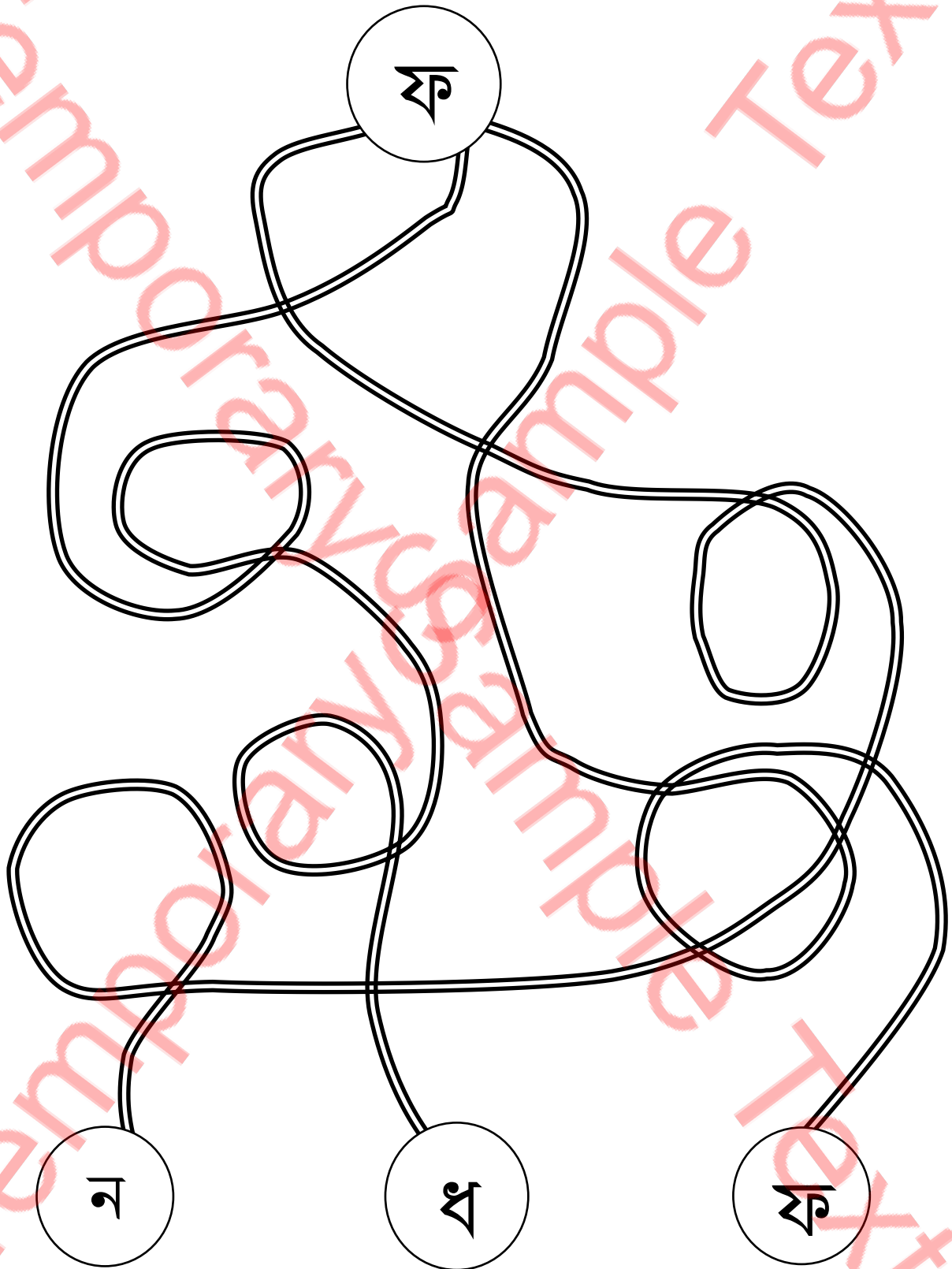

Student Name: _____

Verified By: _____

Class: _____

Date: _____

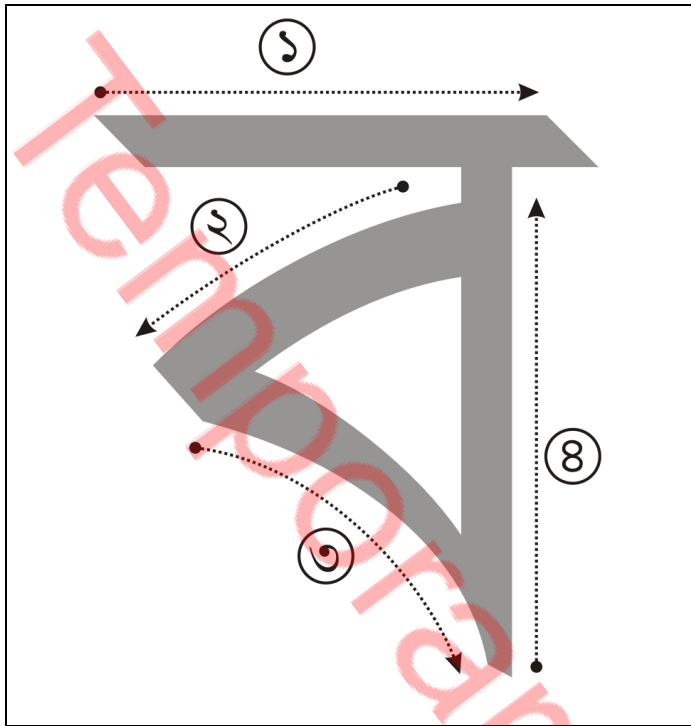

Follow the above steps

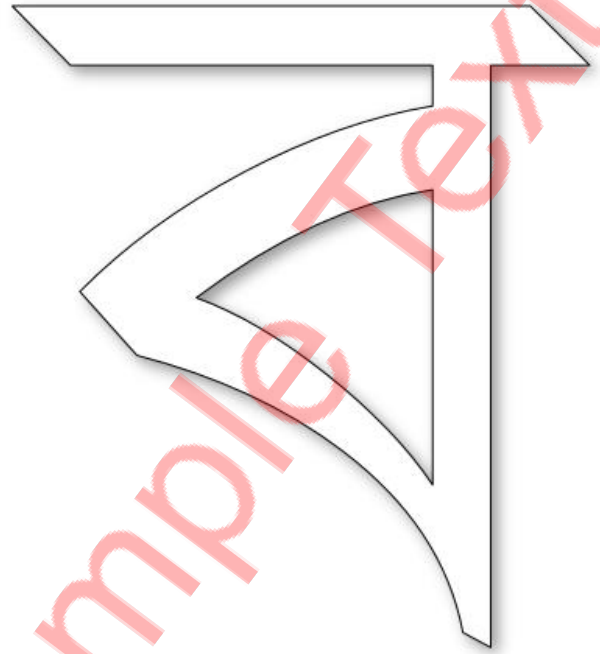

Colour it accordingly

ক	খ	গ	ঘ	ঙ	চ	ছ	জ
ঝ	ঞ	ট	ঠ	ড	ঢ	ণ	ত
থ	দ	ধ	ন	প	ফ	ব	ভ
ম	য	র	ল	শ	ষ	স	হ
ড়	ঢ়	য়	ৌ	্	ৎ	৏	

Student Name: _____

Verified By: _____

Class: _____

Date: _____

Trace It

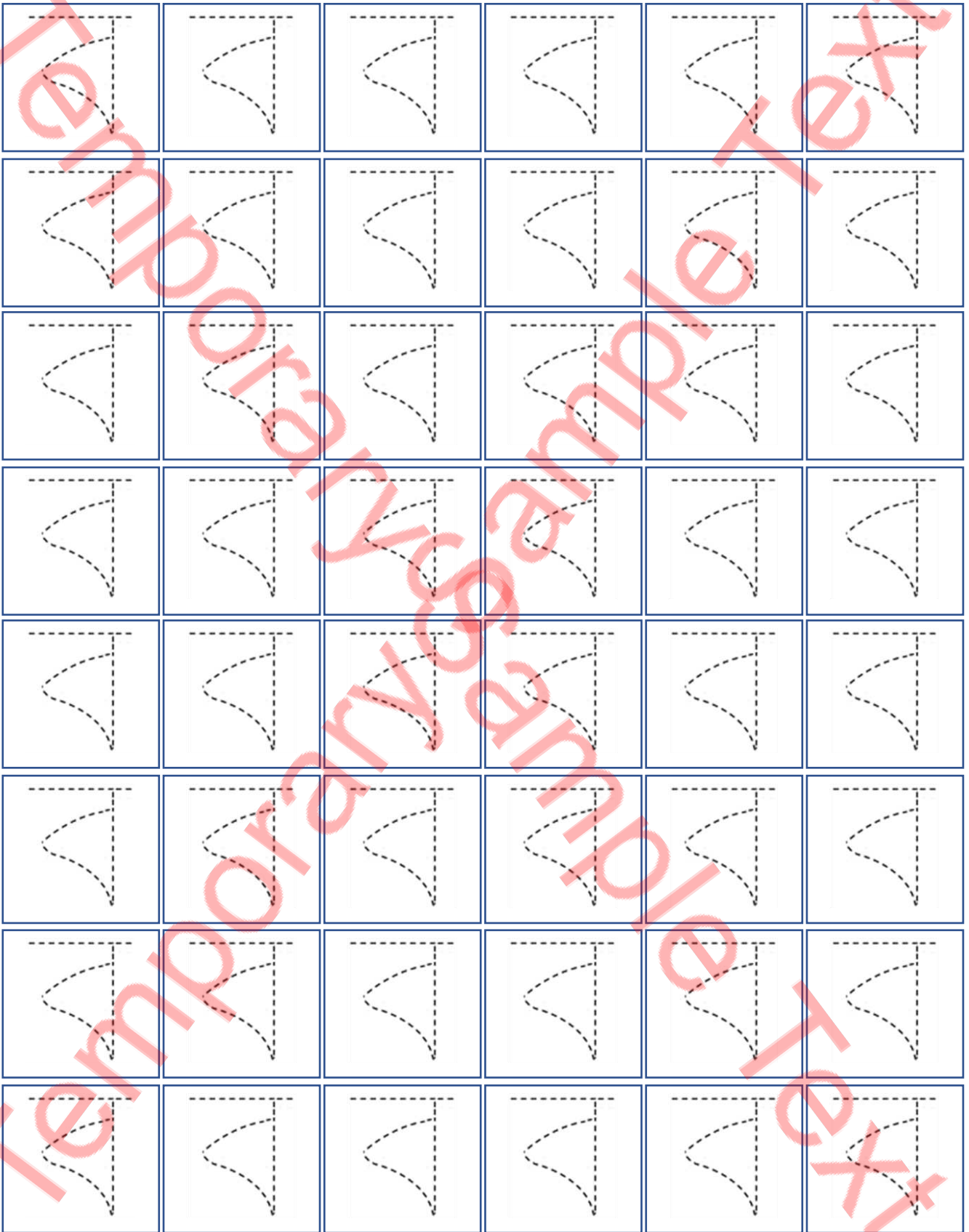

Student Name: _____

Verified By: _____

Class: _____

Date: _____

Trace it

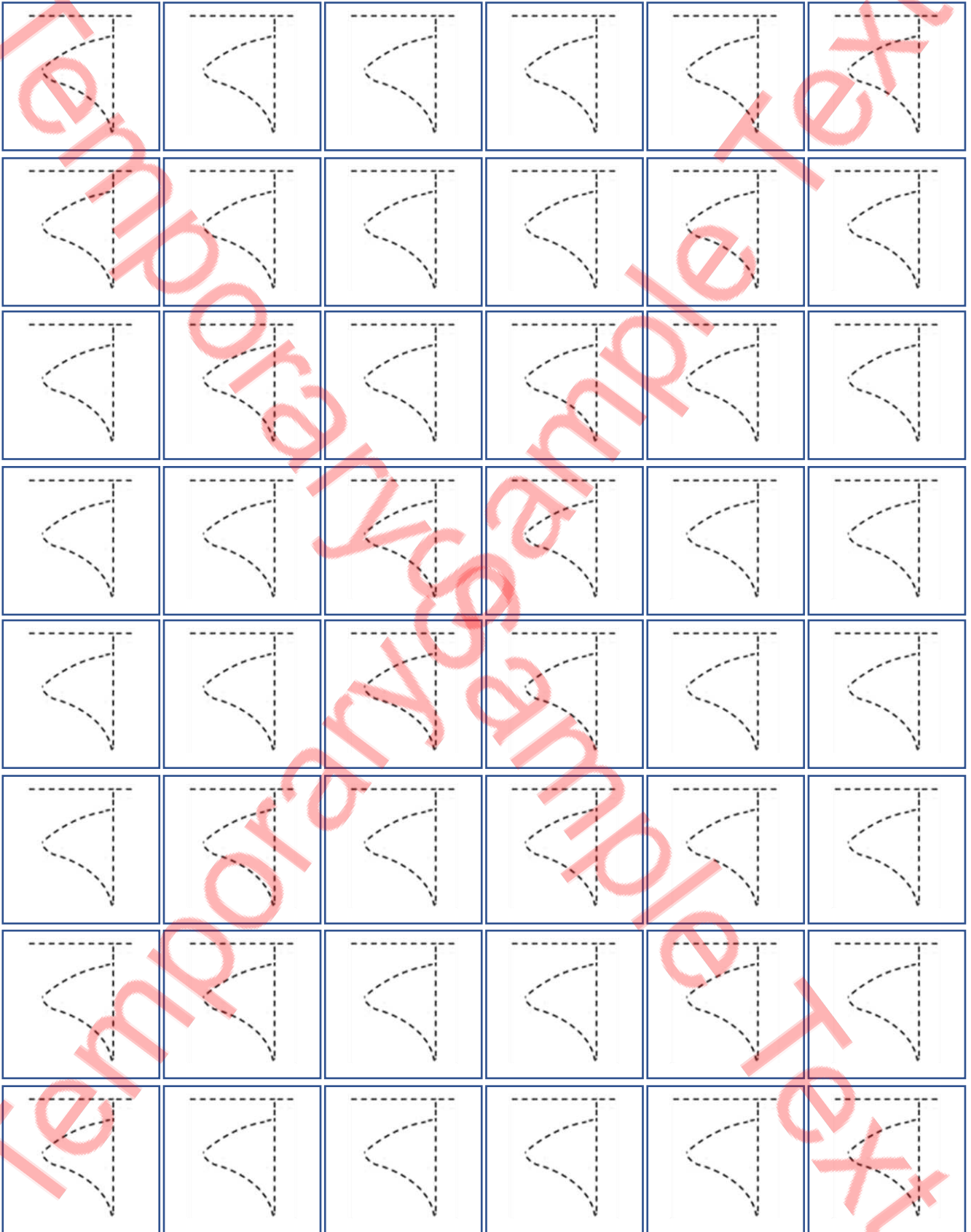

Student Name: _____

Verified By: _____

Class: _____

Date: _____

Write it

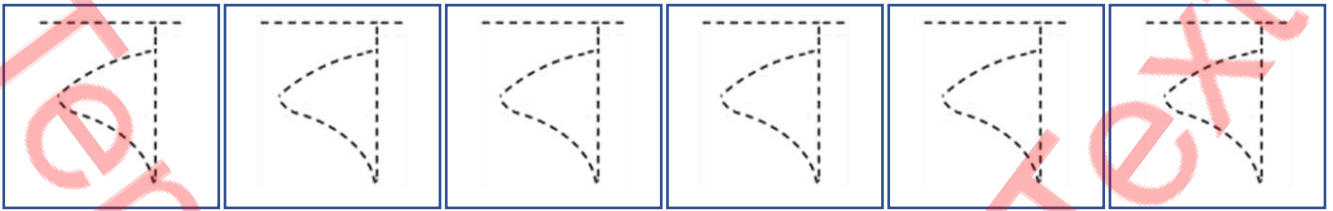

Student Name: _____

Verified By: _____

Class: _____

Date: _____

Copy Colour

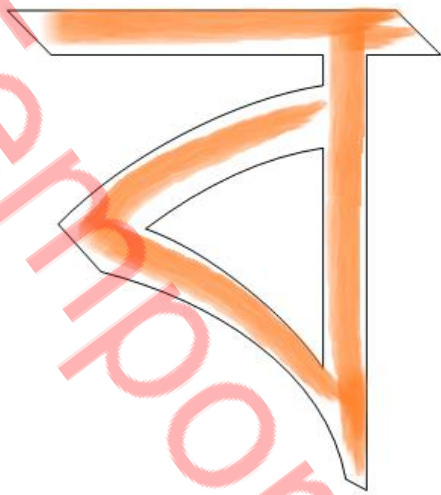

Colour it

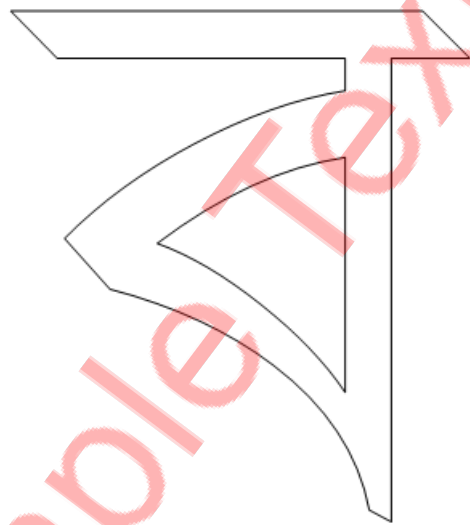

Write it

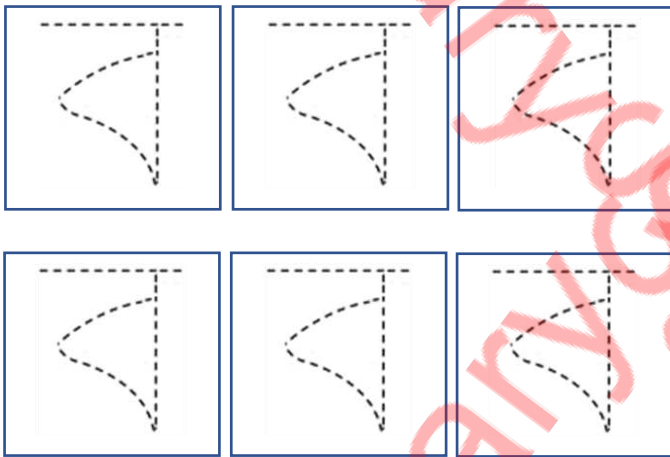

Find it

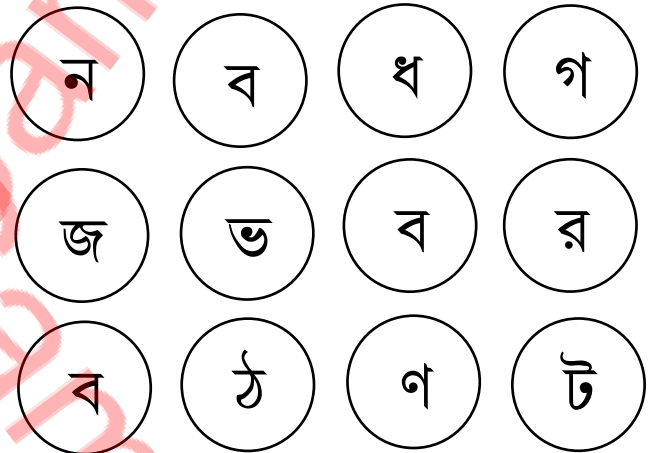

Connect the circle

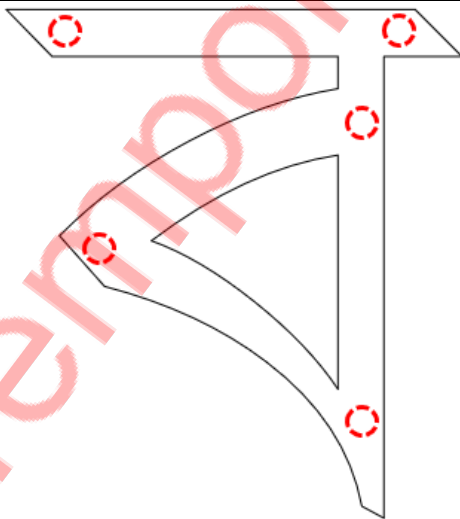

Do it

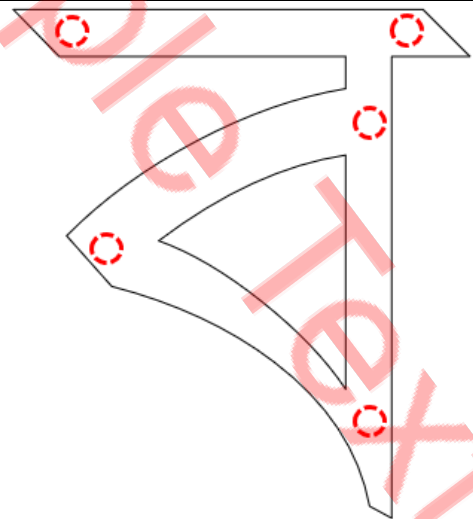

Student Name: _____

Verified By: _____

Class: _____

Date: _____

Pick the Path Find the Correct Alphabet

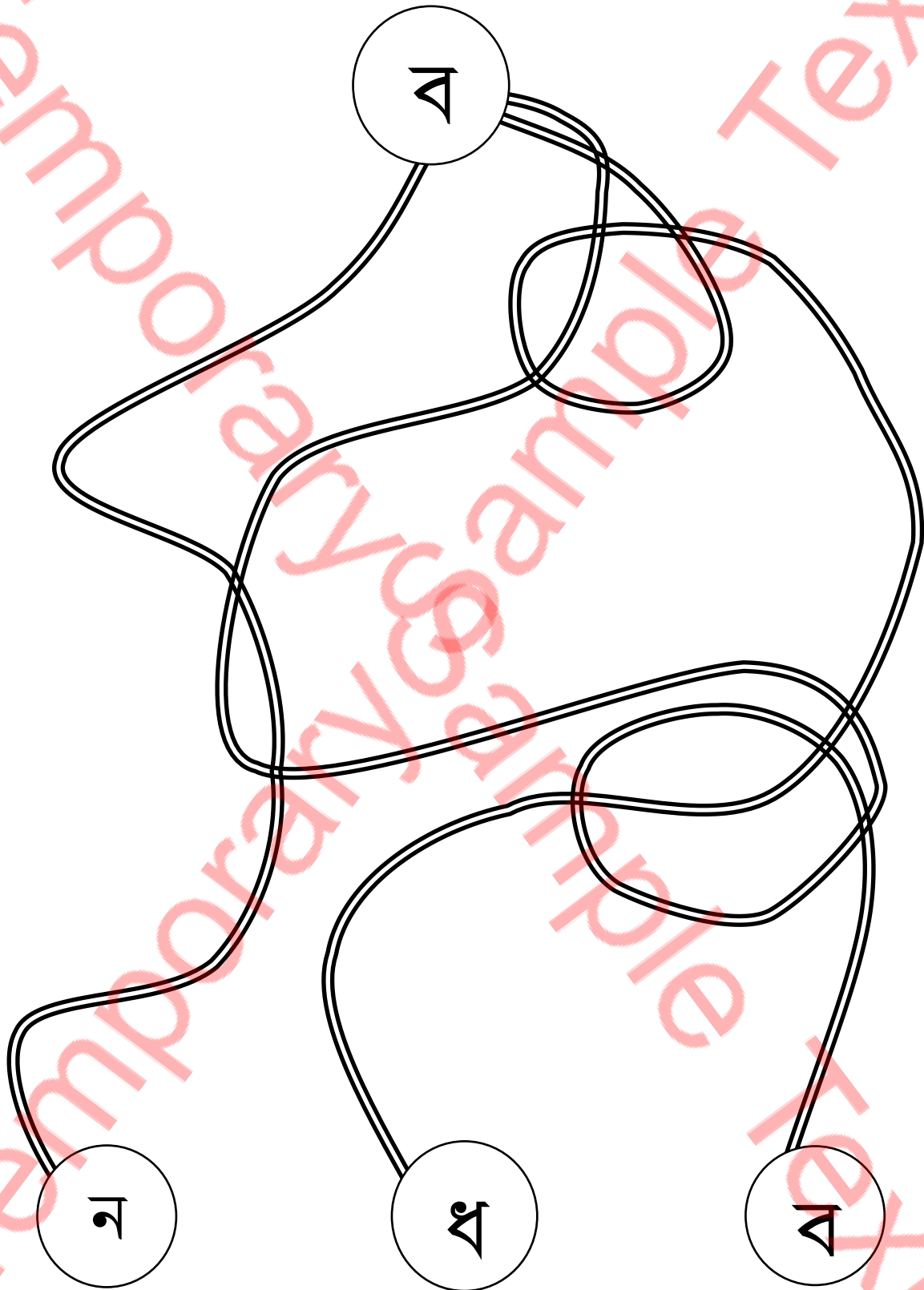

Student Name: _____

Verified By: _____

Class: _____

Date: _____

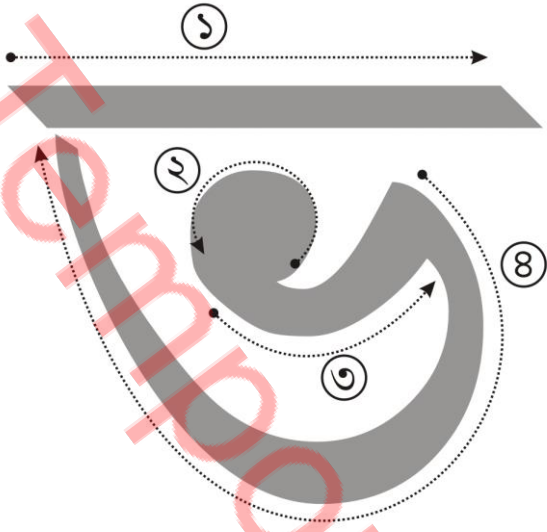

Follow the above steps

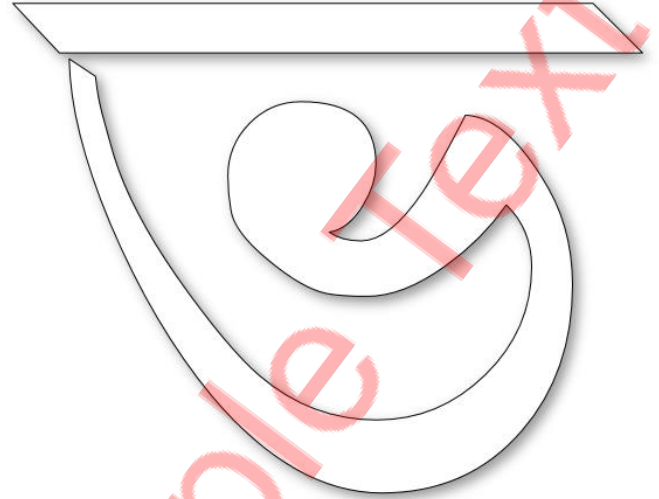

Colour it accordingly

ক	খ	গ	ঘ	ঙ	চ	ছ	জ
ঝ	ঞ	ট	ঠ	ড	ঢ	ণ	ত
থ	দ	ধ	ন	প	ফ	ব	ভ
ম	য	র	ত্র	শ	ষ	স	হ
ড়	ঢ়	য়	ৎ	ৎ	ঃ	ঁ	

Student Name: _____

Verified By: _____

Class: _____

Date: _____

Trace It



Student Name: _____

Verified By: _____

Class: _____

Date: _____

Trace it



Student Name: _____

Verified By: _____

Class: _____

Date: _____

Write it

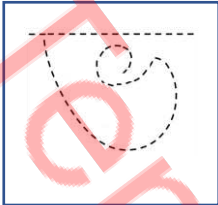
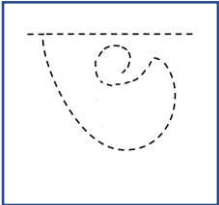
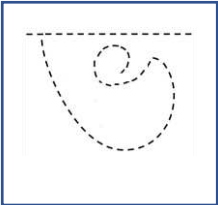
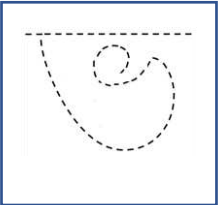
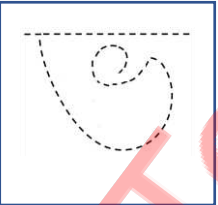
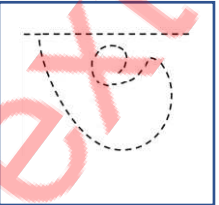
Student Name: _____

Verified By: _____

Class: _____

Date: _____

Copy Colour

Colour it

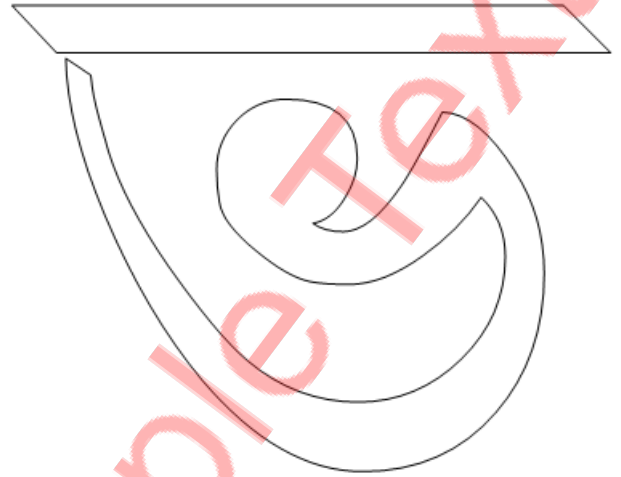

Write it

Find it

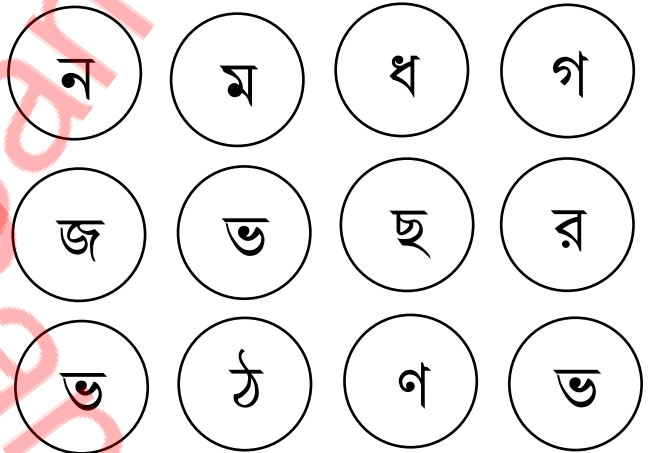
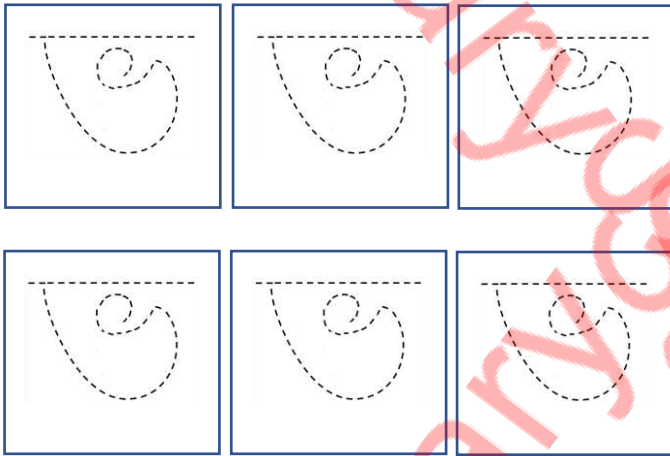

Connect the circle

Do it

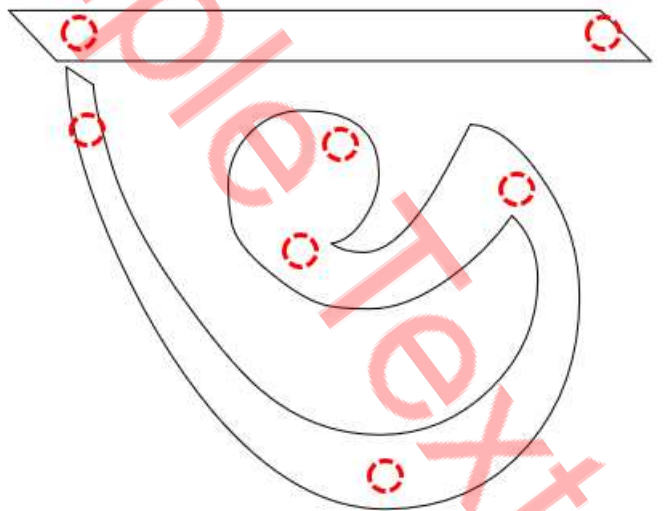
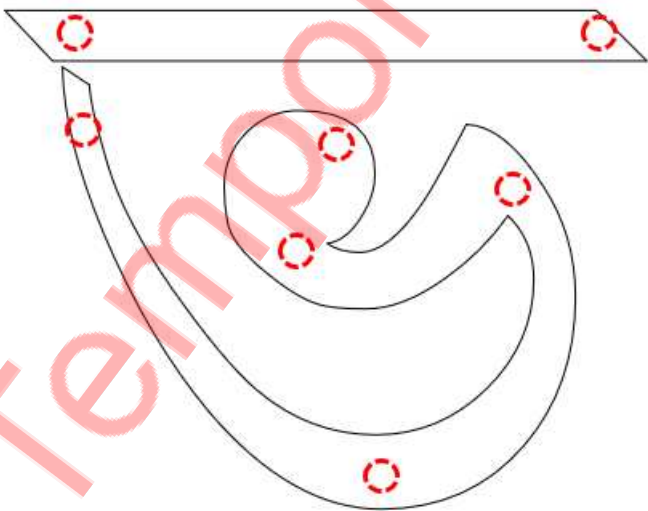

Student Name: _____

Verified By: _____

Class: _____

Date: _____

Pick the Path Find the Correct Alphabet

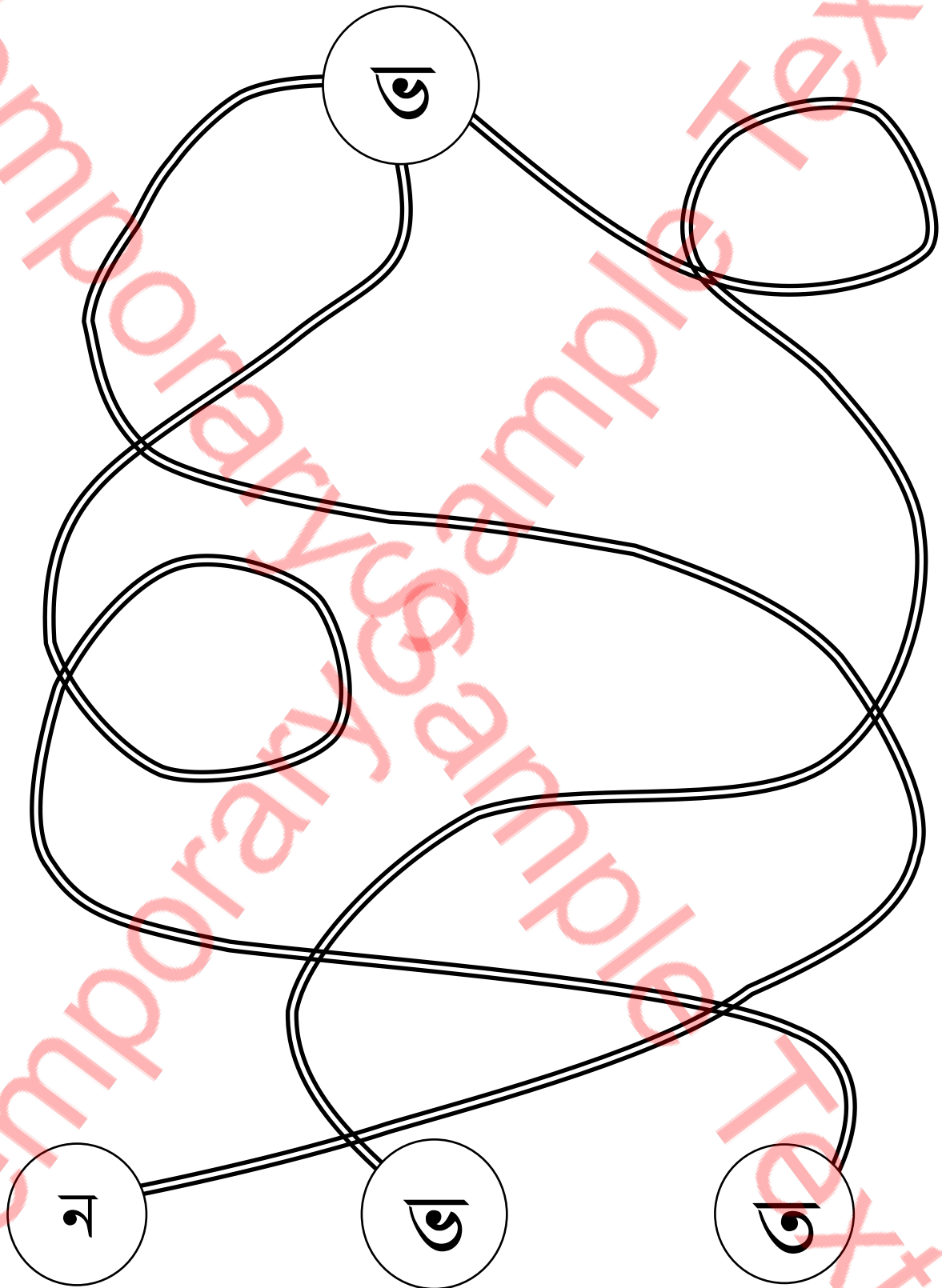

Student Name: _____

Verified By: _____

Class: _____

Date: _____

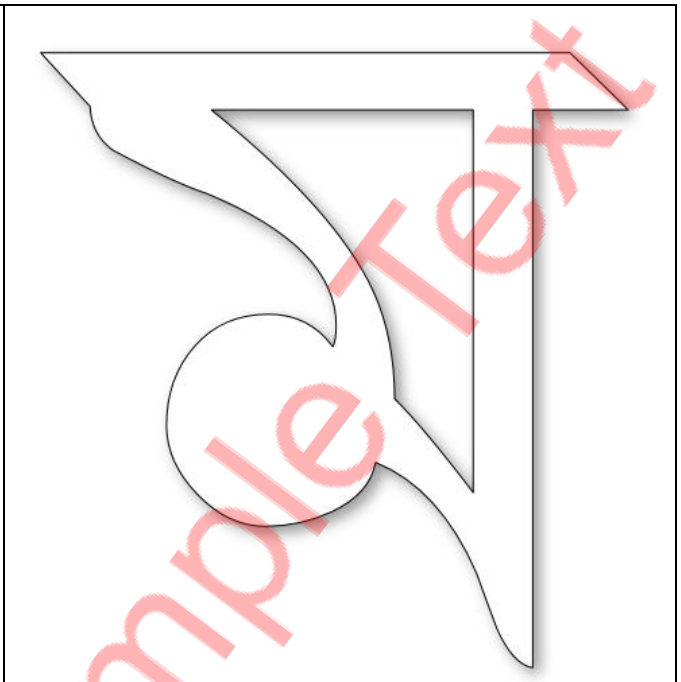
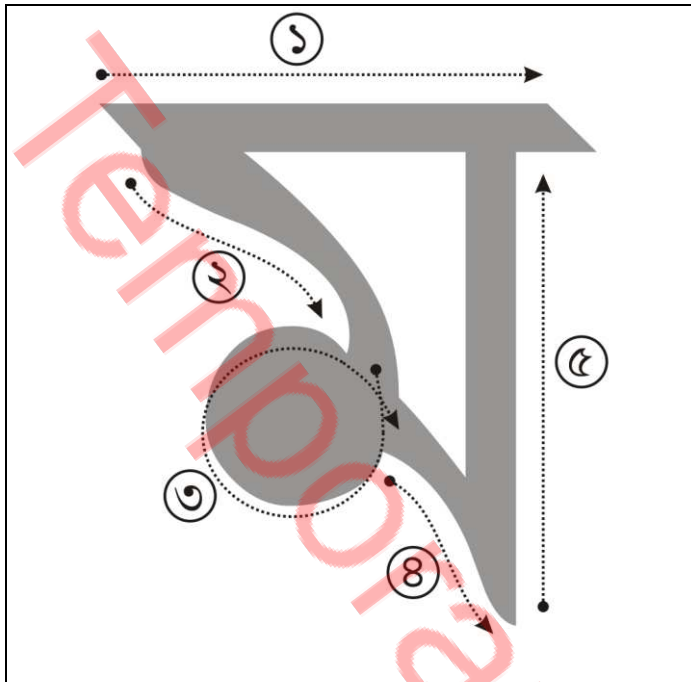

Follow the above steps

Colour it accordingly

ক	খ	গ	ঘ	ঙ	চ	ছ	জ
ঝ	ঞ	ট	ঠ	ড	ঢ	ণ	ত
থ	দ	ধ	ন	প	ফ	ব	ভ
ম	য	র	ল	শ	ষ	স	হ
ড়	ঢ়	য়	ৌ	্	ৎ	৏	

Student Name: _____

Verified By: _____

Class: _____

Date: _____

Trace It



Student Name: _____

Verified By: _____

Class: _____

Date: _____

Trace it



Student Name: _____

Verified By: _____

Class: _____

Date: _____

Write it

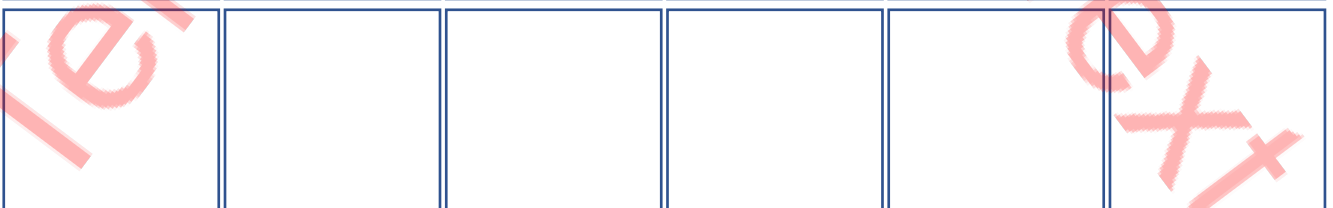
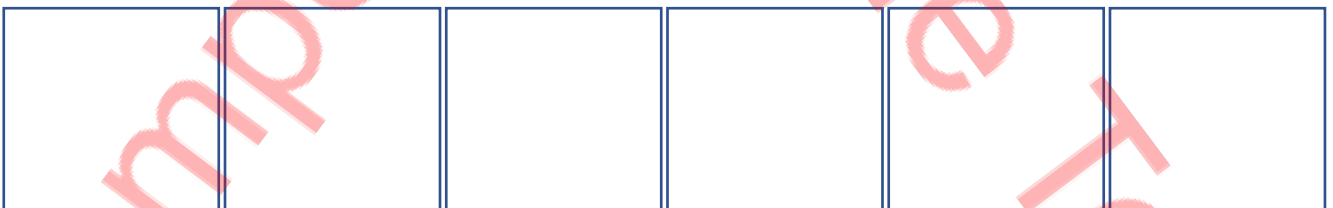
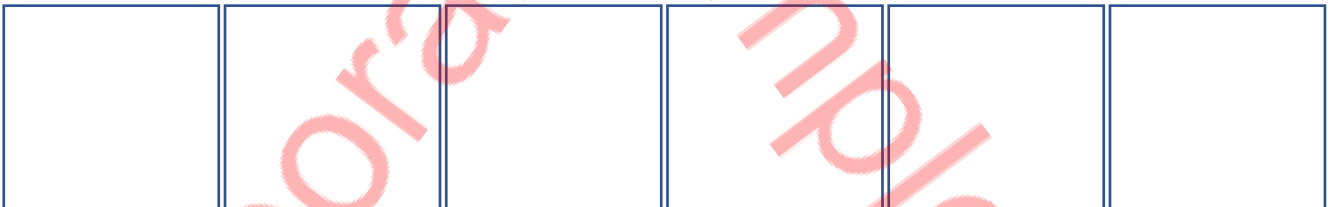
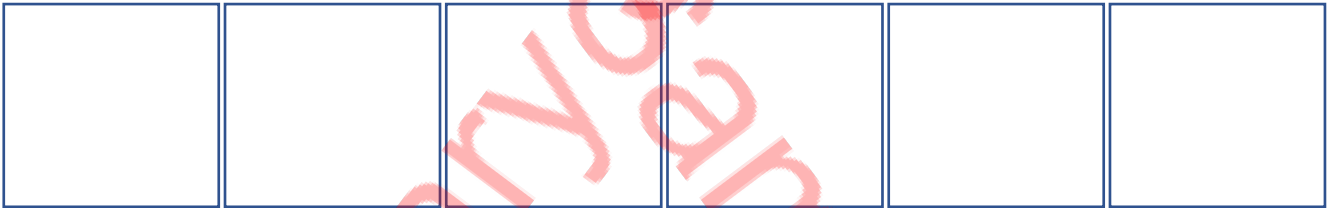
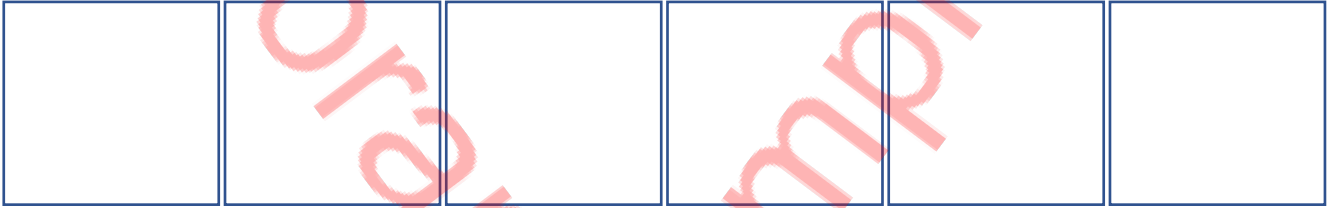
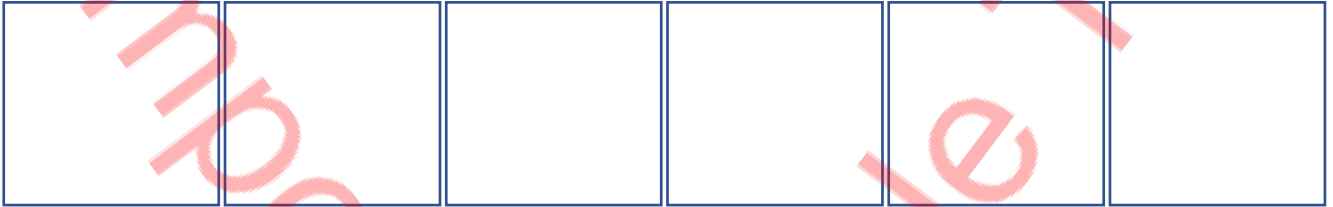
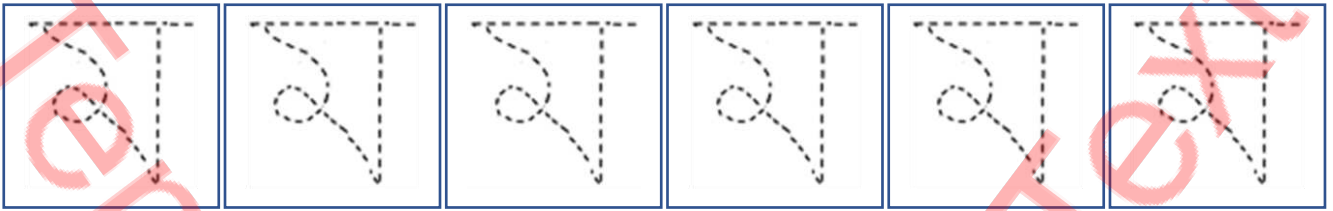

Student Name: _____

Verified By: _____

Class: _____

Date: _____

Copy Colour

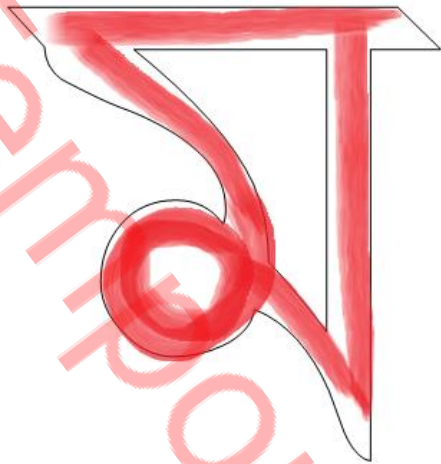

Colour it

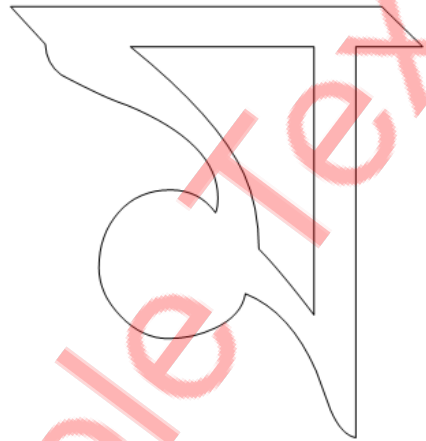

Write it

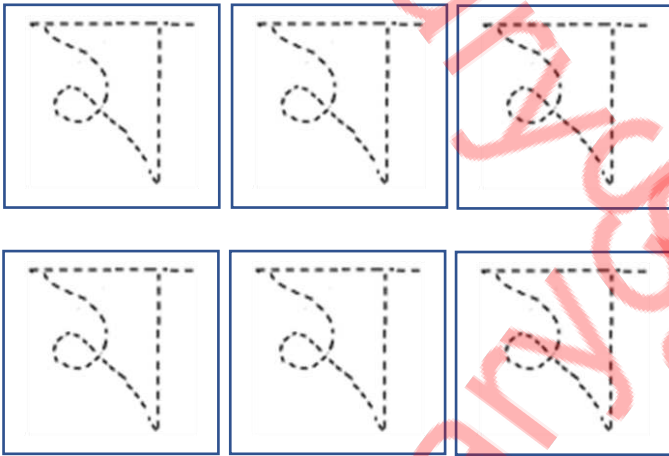

Find it

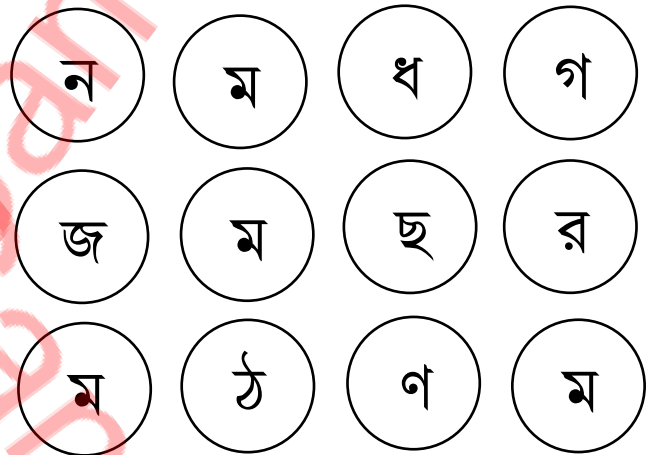

Connect the circle

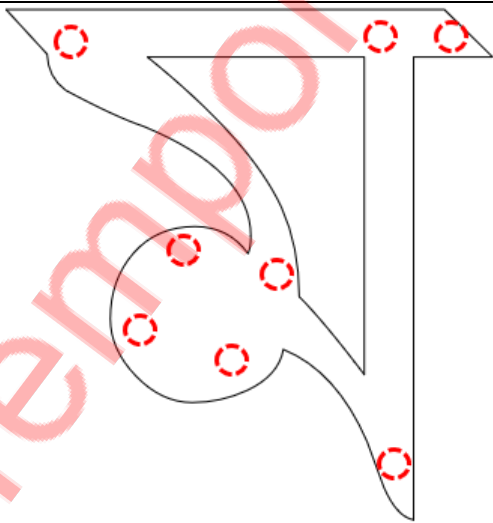

Do it

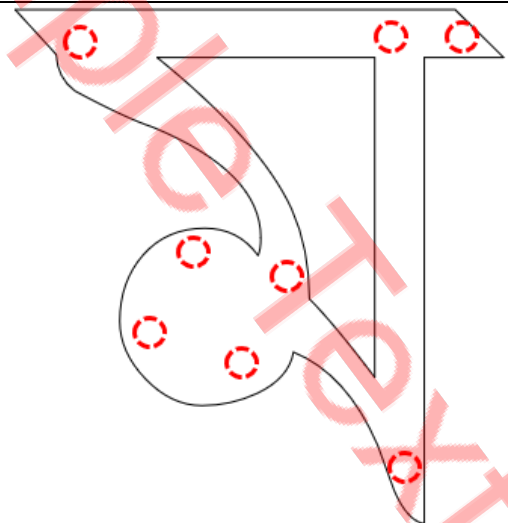

Student Name: _____

Verified By: _____

Class: _____

Date: _____

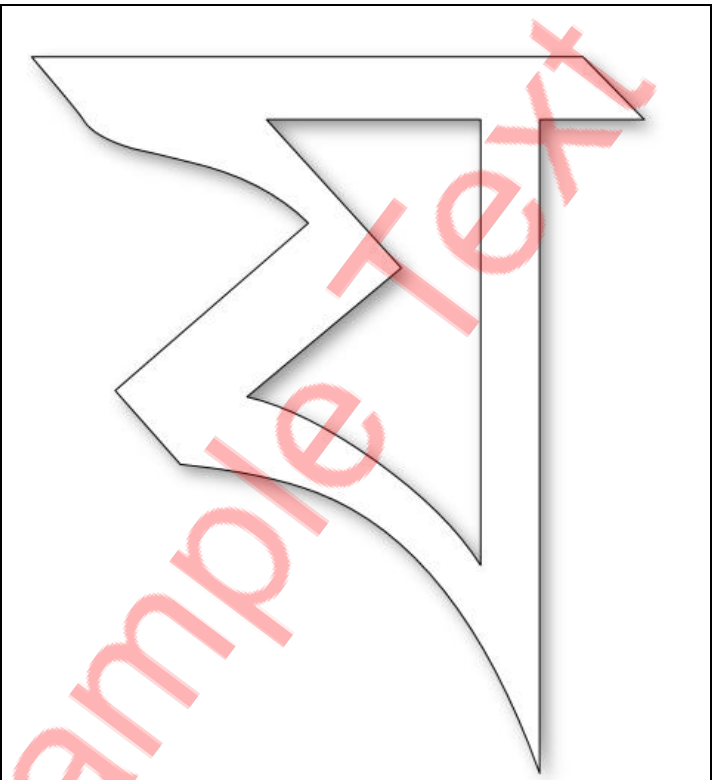
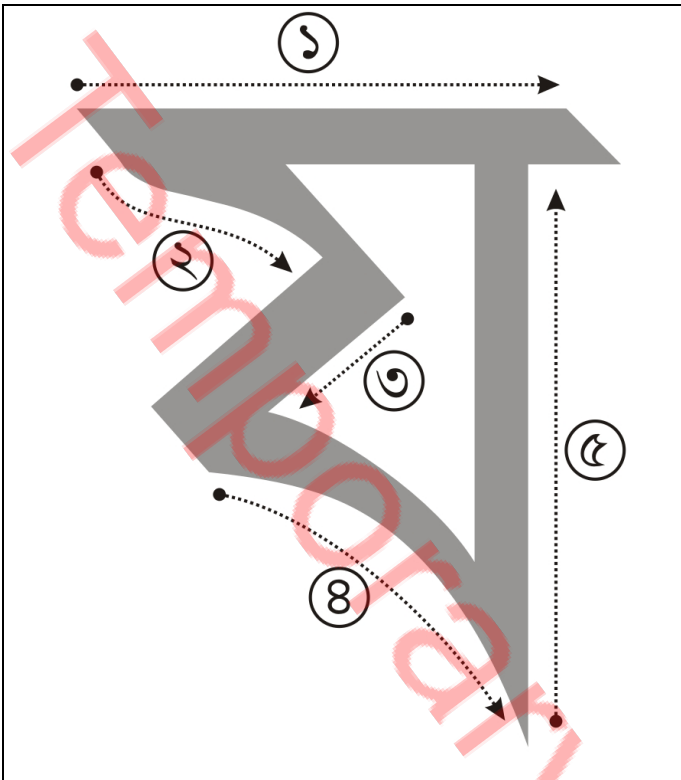

Follow the above steps

Colour it accordingly

ক	খ	গ	ঘ	ঙ	চ	ছ	জ
ঝ	ঞ	ট	ঠ	ড	ঢ	ণ	ত
থ	দ	ধ	ন	প	ফ	ব	ভ
ম	য	র	ল	শ	ষ	স	হ
ড়	ঢ়	য়	ৌ	্	ৎ	৏	

Student Name: _____

Verified By: _____

Class: _____

Date: _____

Trace It



Student Name: _____

Verified By: _____

Class: _____

Date: _____

Trace it



Student Name: _____

Verified By: _____

Class: _____

Date: _____

Write it

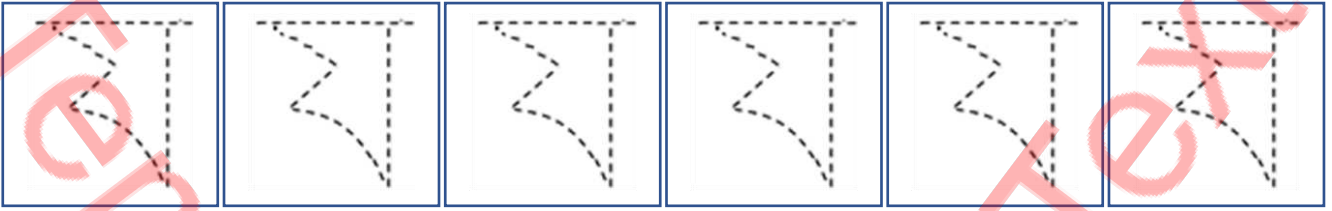

Student Name: _____

Verified By: _____

Class: _____

Date: _____

Copy Colour



Colour it

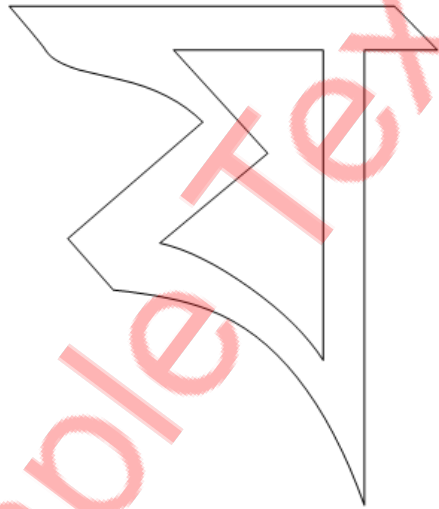

Write it

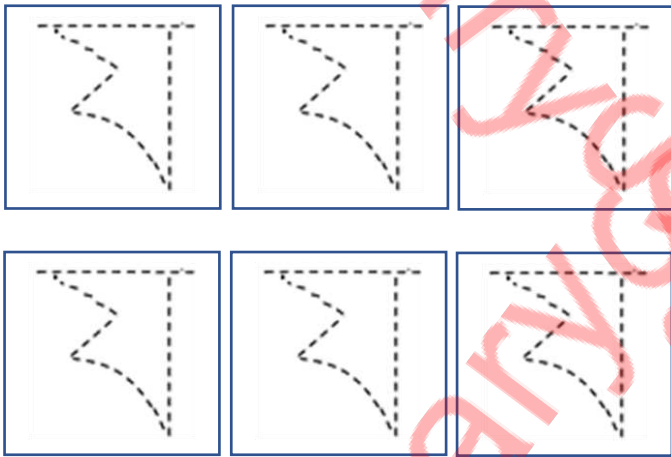

Find it

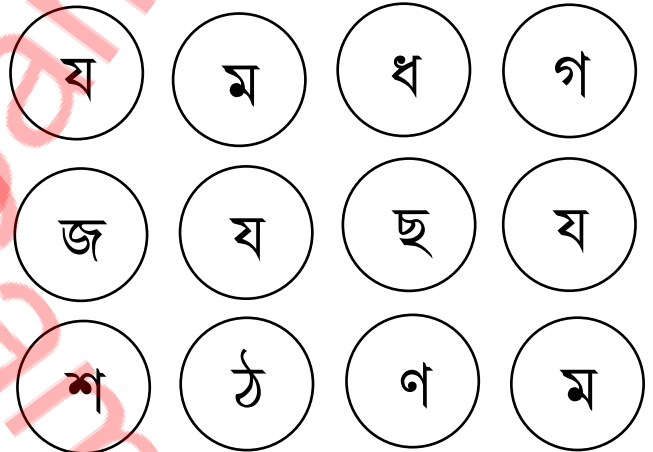

Connect the circle

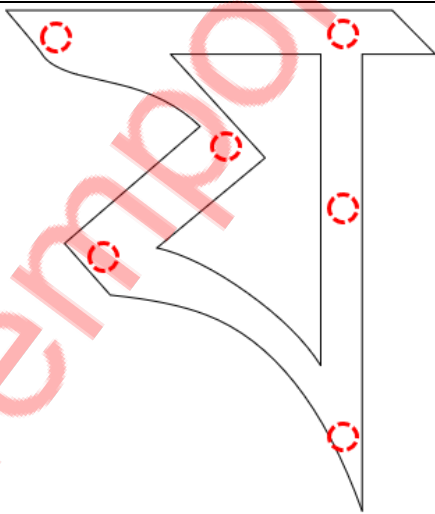

Do it

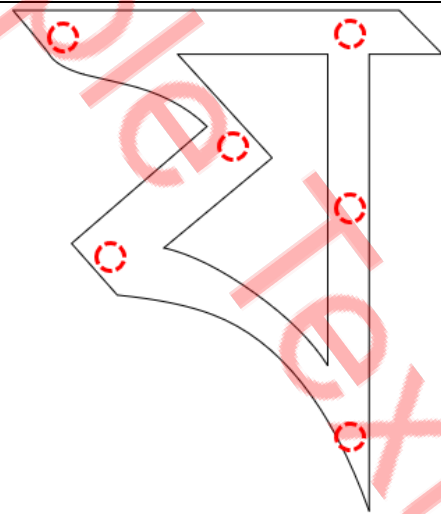

Student Name: _____

Verified By: _____

Class: _____

Date: _____

Pick the Path Find the Correct Alphabet

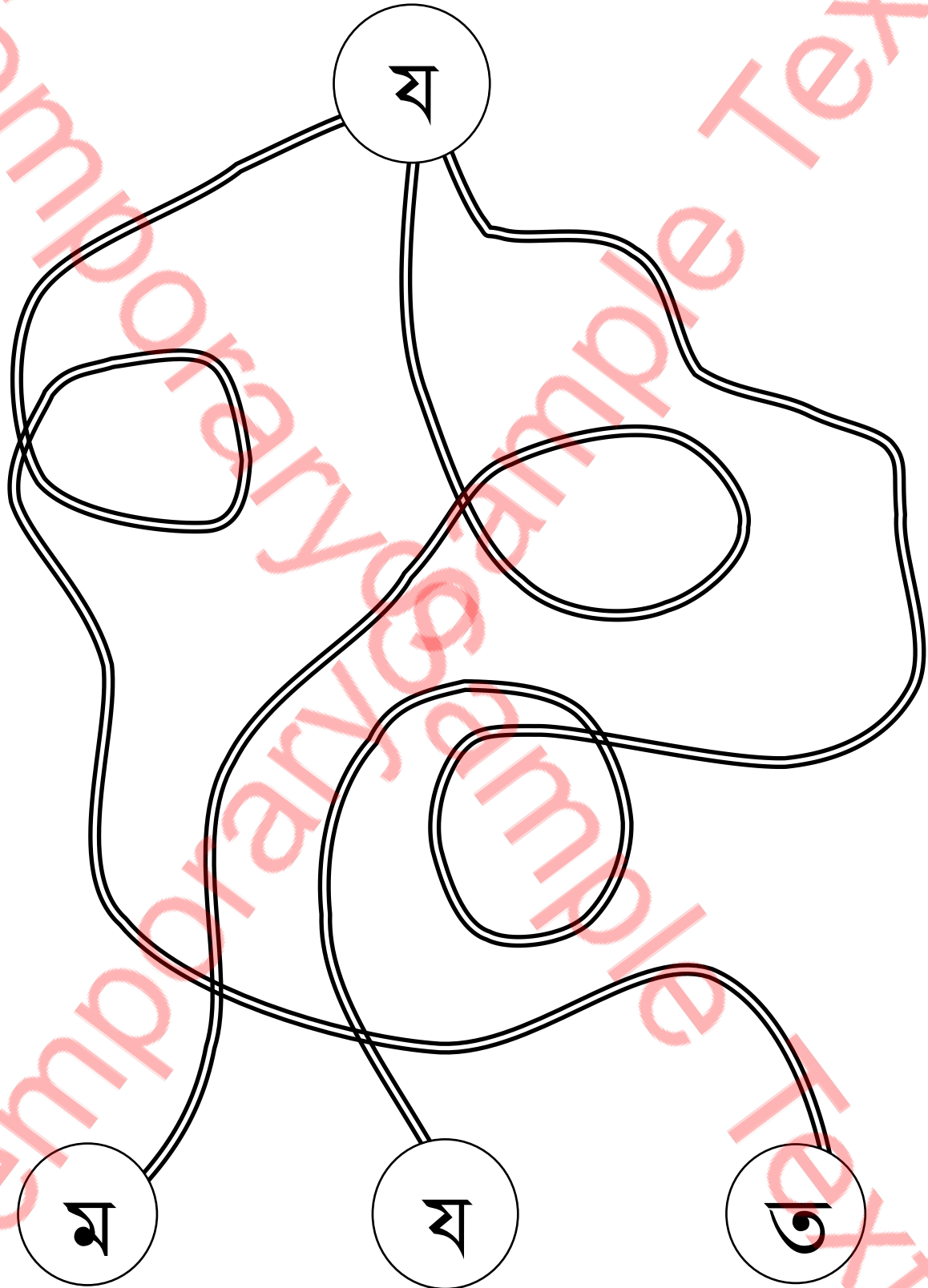

Student Name: _____

Verified By: _____

Class: _____

Date: _____

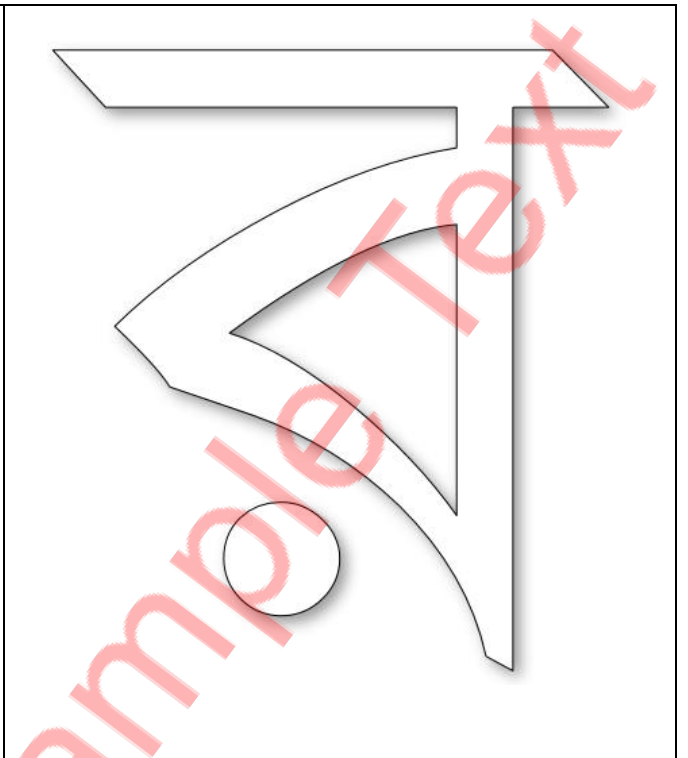
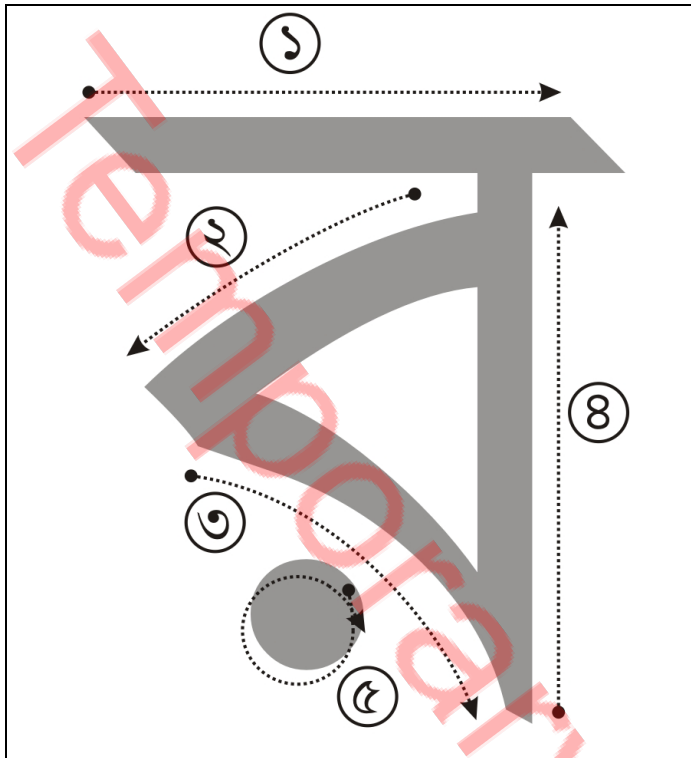

Follow the above steps

Colour it accordingly

ক	খ	গ	ঘ	ঙ	চ	ছ	জ
ঝ	ঞ	ট	ঠ	ড	ঢ	ণ	ত
থ	দ	ধ	ন	প	ফ	ব	ভ
ম	য	র	ল	শ	ষ	স	হ
ড়	ঢ়	য়	ৱ	৲	৳	৴	

Student Name: _____

Verified By: _____

Class: _____

Date: _____

Trace It

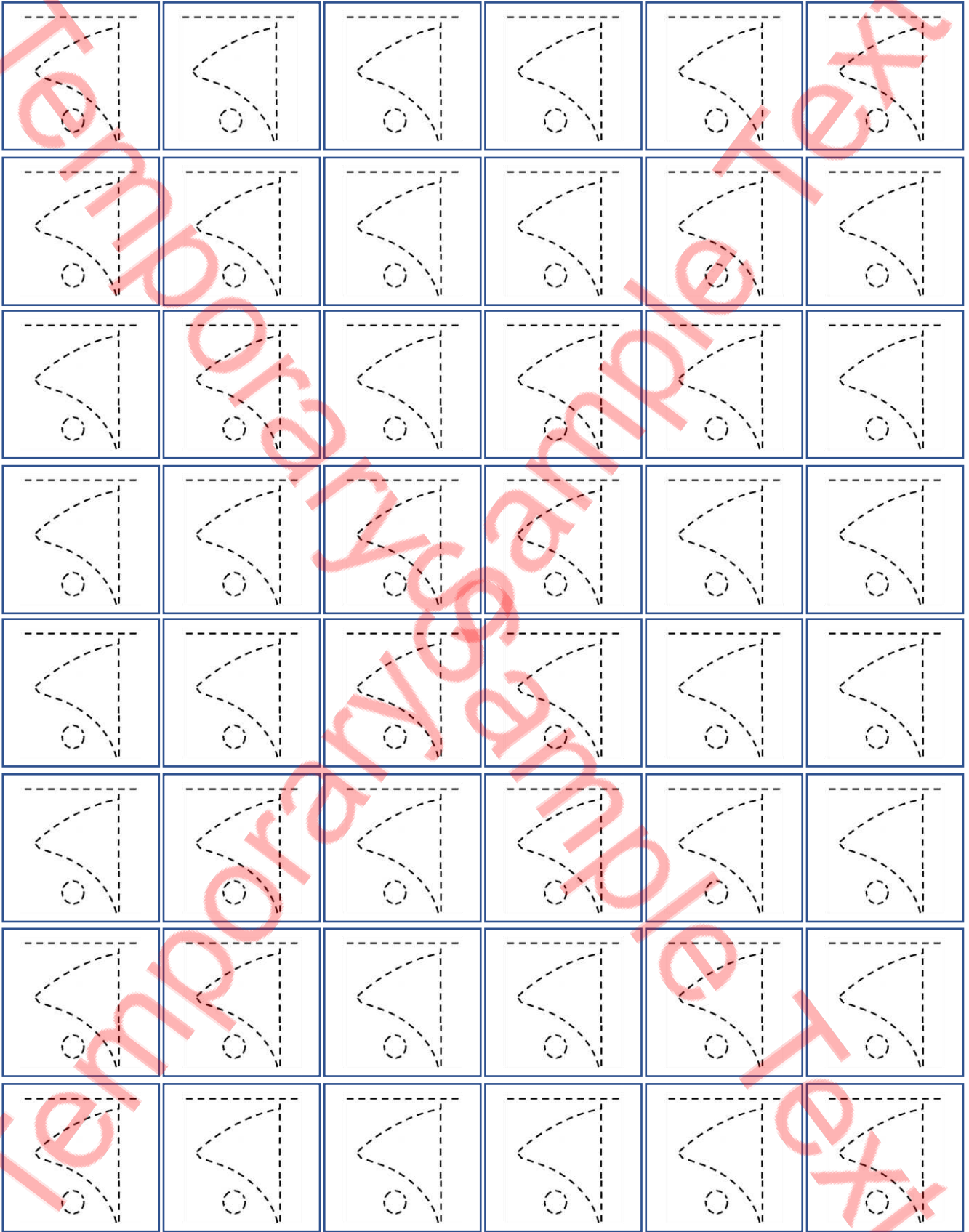

Student Name: _____

Verified By: _____

Class: _____

Date: _____

Trace it

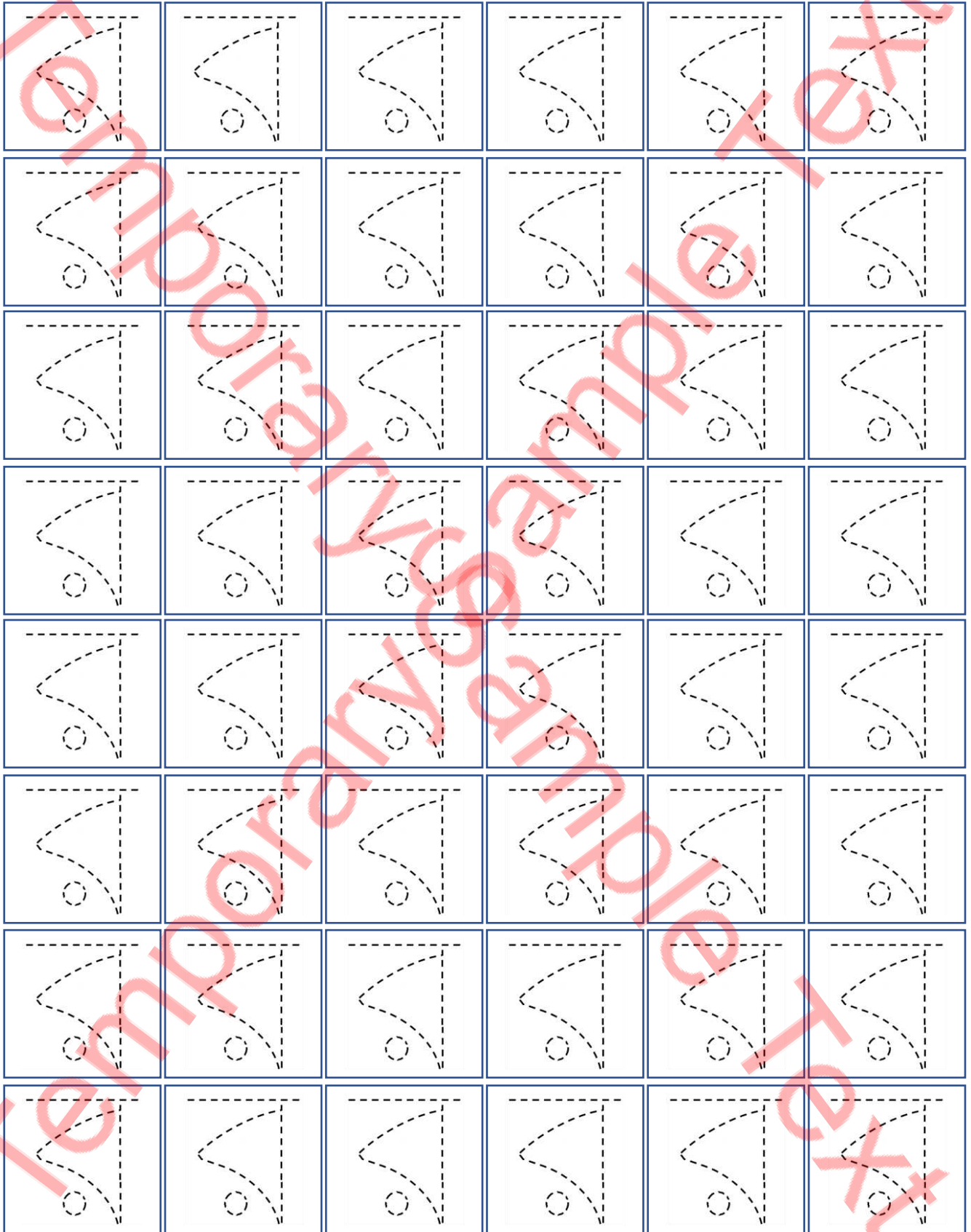

Student Name: _____

Verified By: _____

Class: _____

Date: _____

Write it

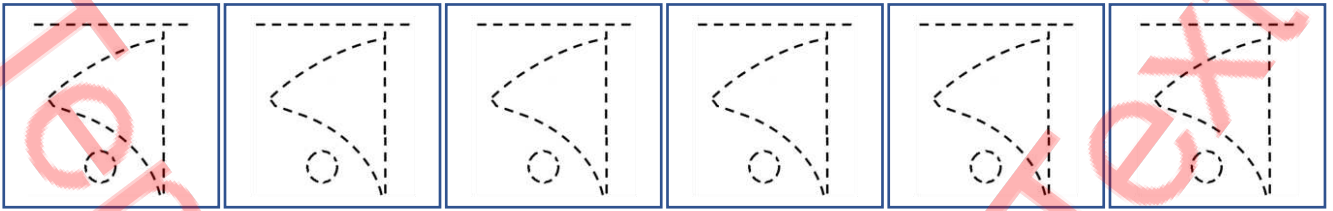

Student Name: _____

Verified By: _____

Class: _____

Date: _____

Copy Colour

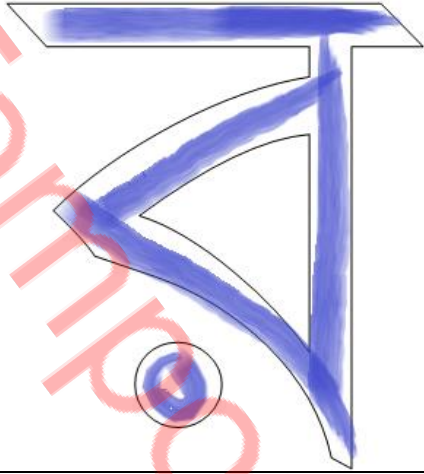

Colour it

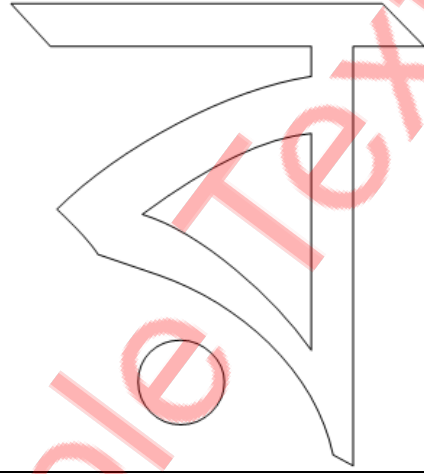

Write it

Find it

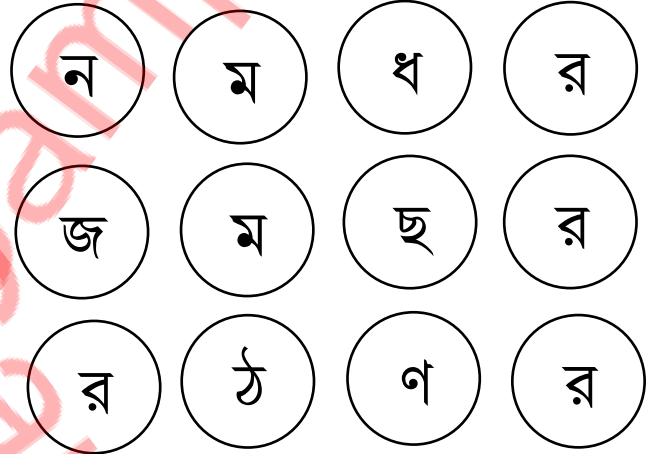
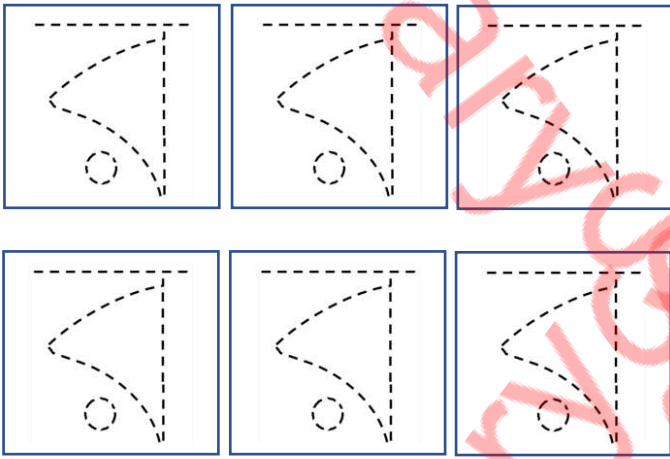

Connect the circle

Do it

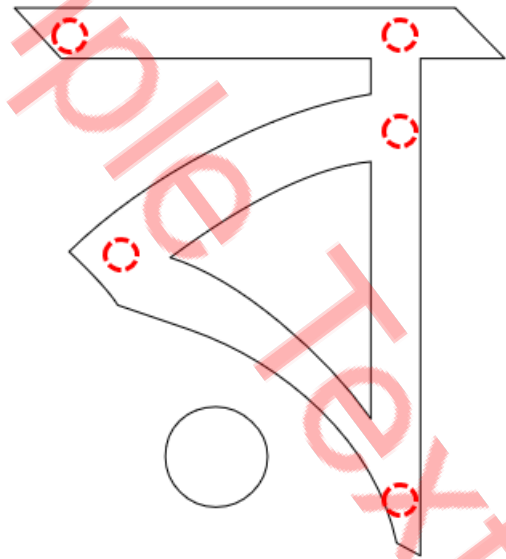
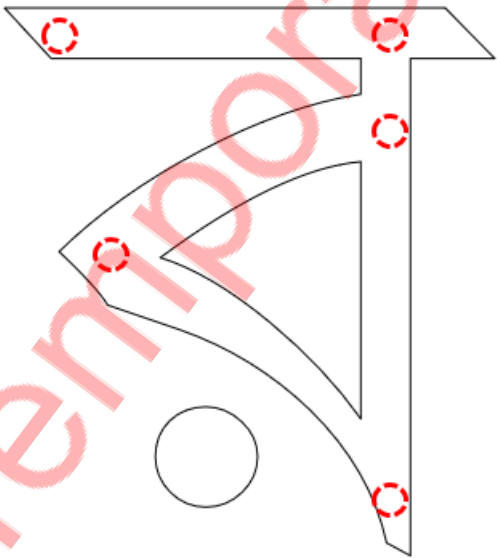

Student Name: _____

Verified By: _____

Class: _____

Date: _____

Pick the Path Find the Correct Alphabet

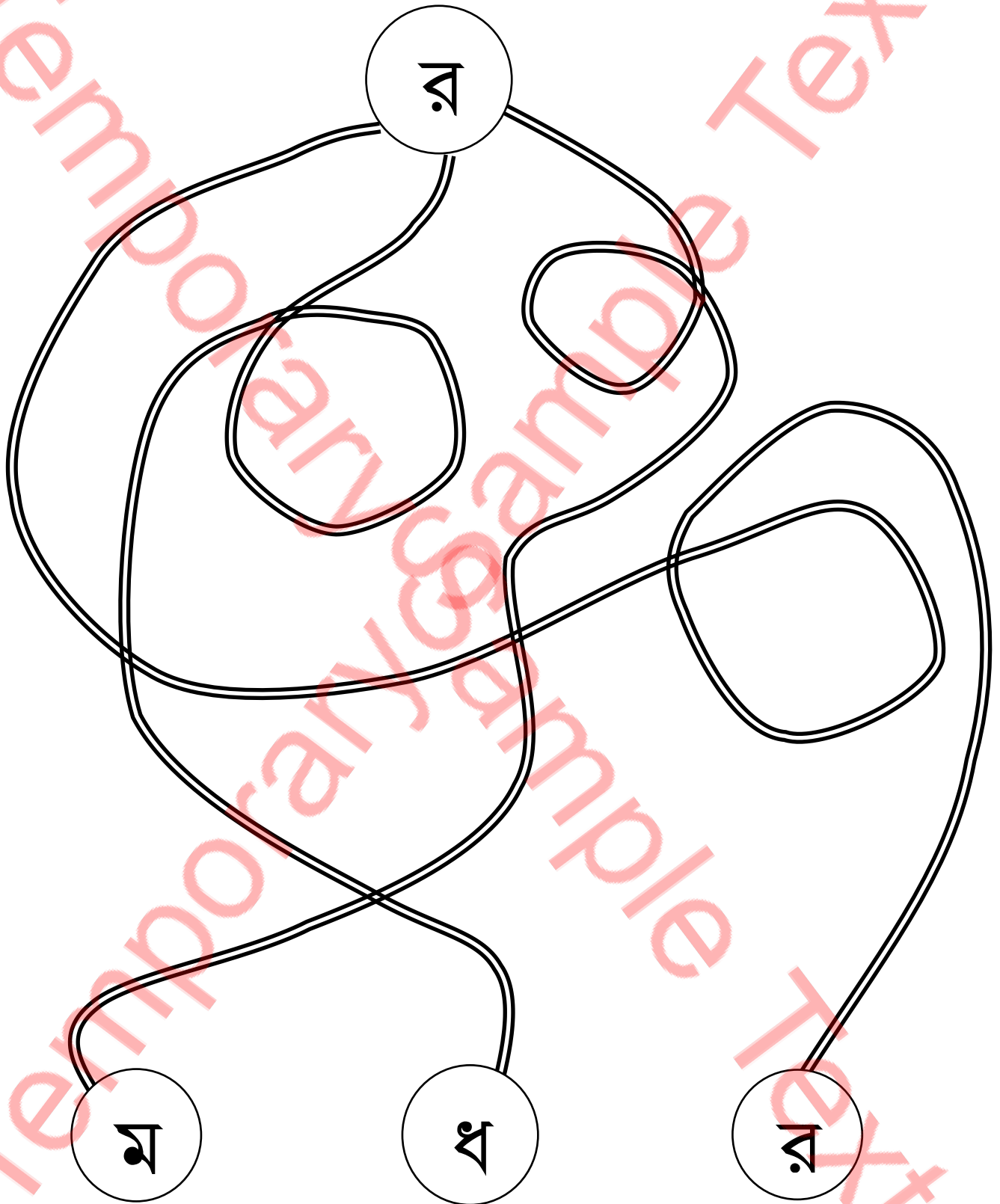

Student Name: _____

Verified By: _____

Class: _____

Date: _____

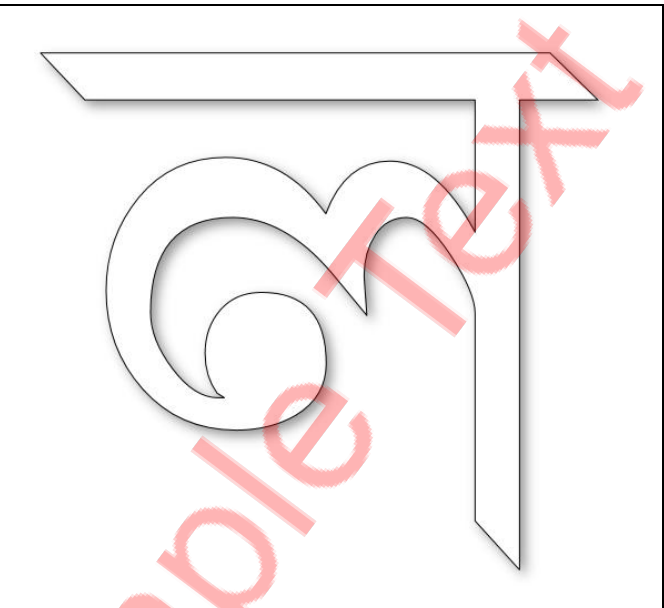
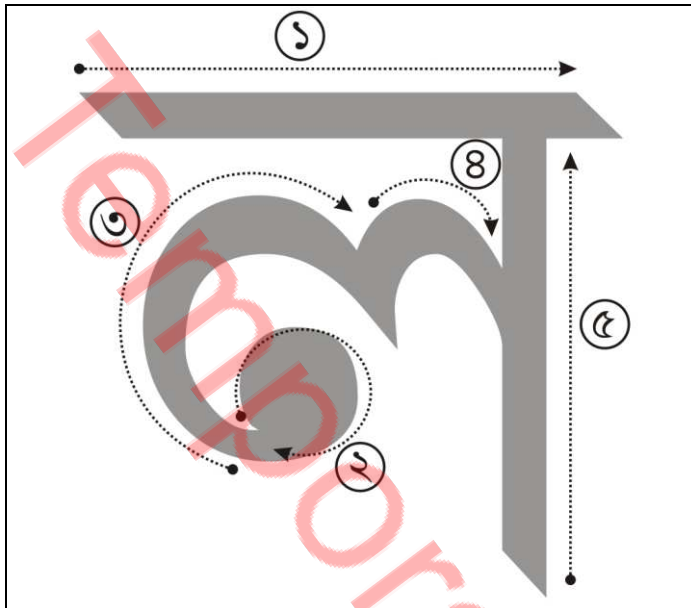

Follow the above steps

Colour it accordingly

ক	খ	গ	ঘ	ঙ	চ	ছ	জ
ঝ	ঞ	ট	ঠ	ড	ঢ	ণ	ত
থ	দ	ধ	ন	প	ফ	ব	ভ
ম	য	র	ল	শ	ষ	স	হ
ড়	ঢ়	য়	ৱ	৲	৳	৴	

Student Name: _____

Verified By: _____

Class: _____

Date: _____

Trace It

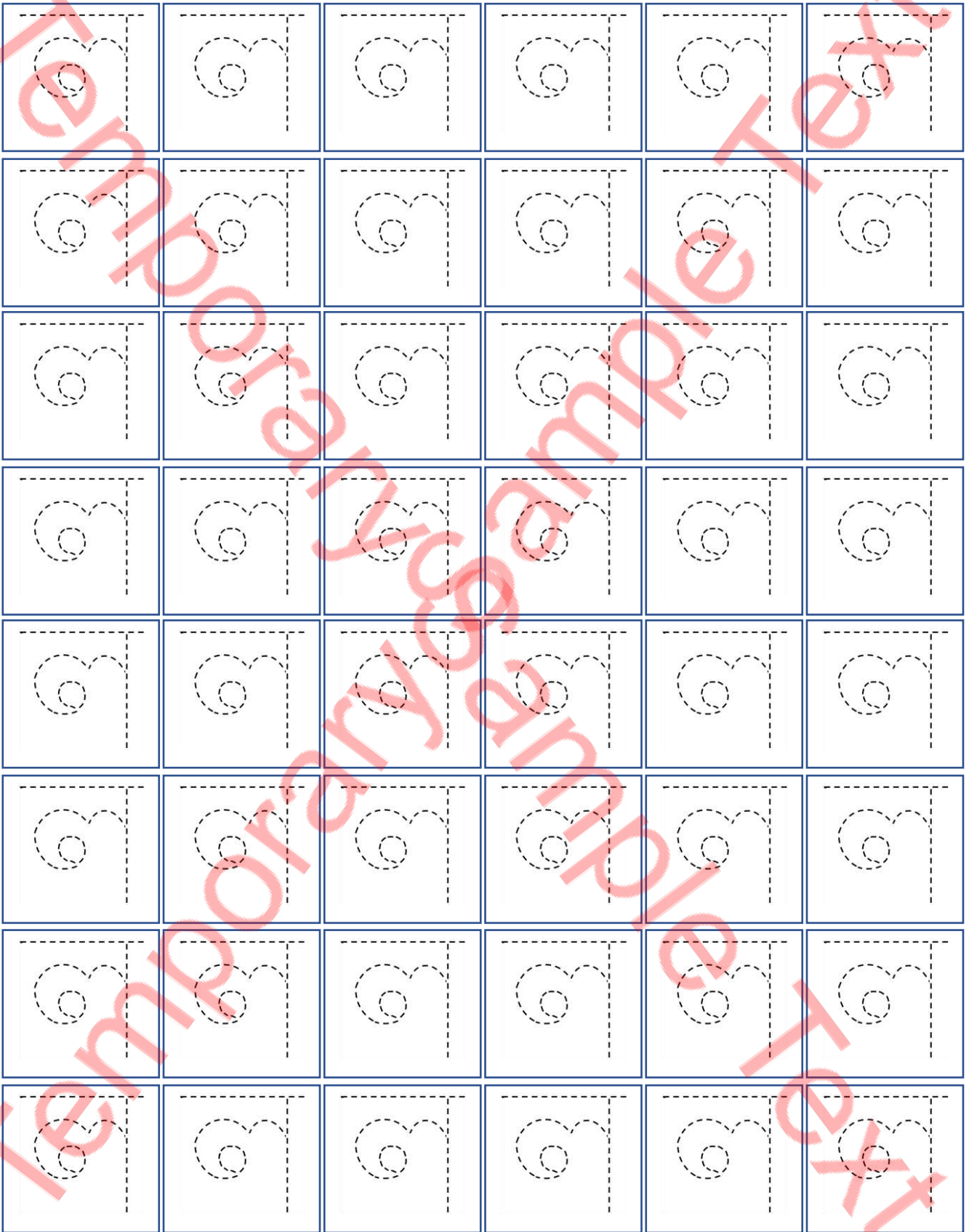

Student Name: _____

Verified By: _____

Class: _____

Date: _____

Trace it

Student Name: _____

Verified By: _____

Class: _____

Date: _____

Write it

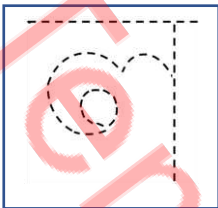
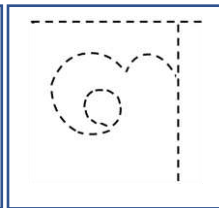
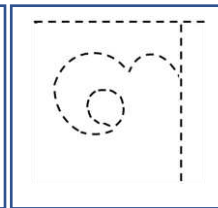
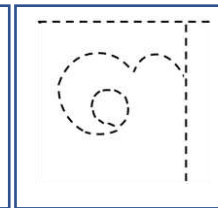
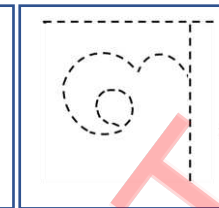
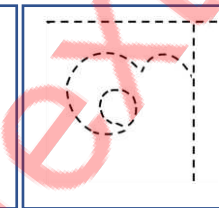
Student Name: _____

Verified By: _____

Class: _____

Date: _____

Copy Colour

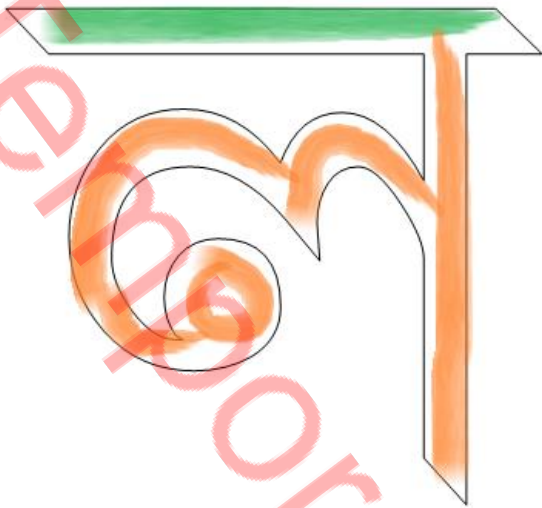

Colour it

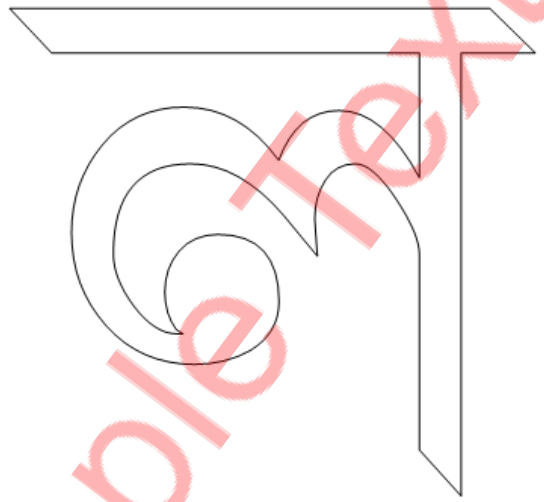

Write it

Find it

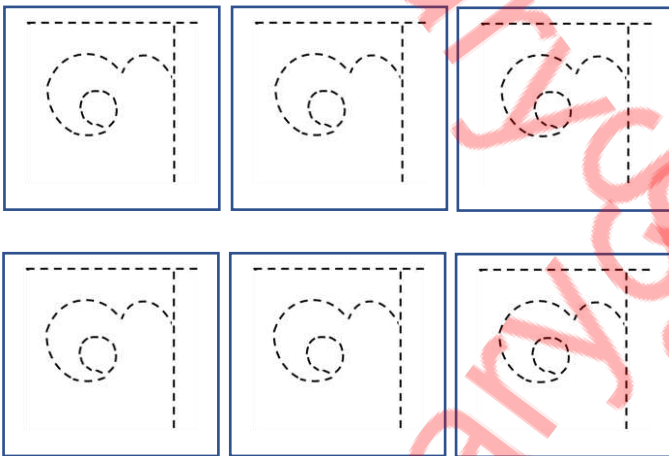

Connect the circle

Do it

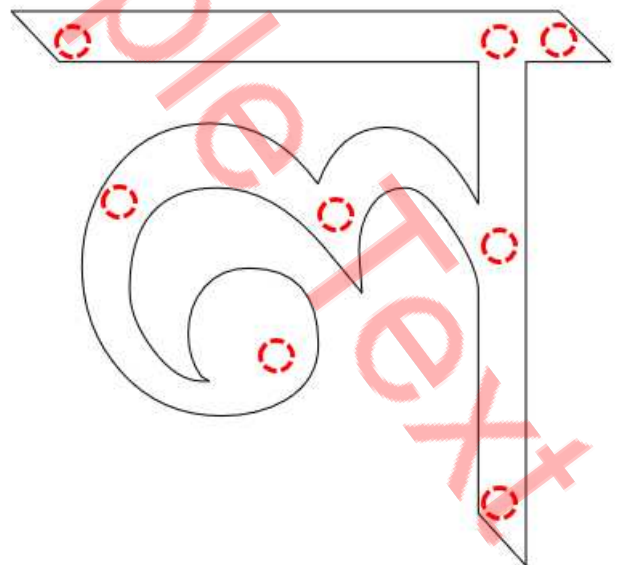
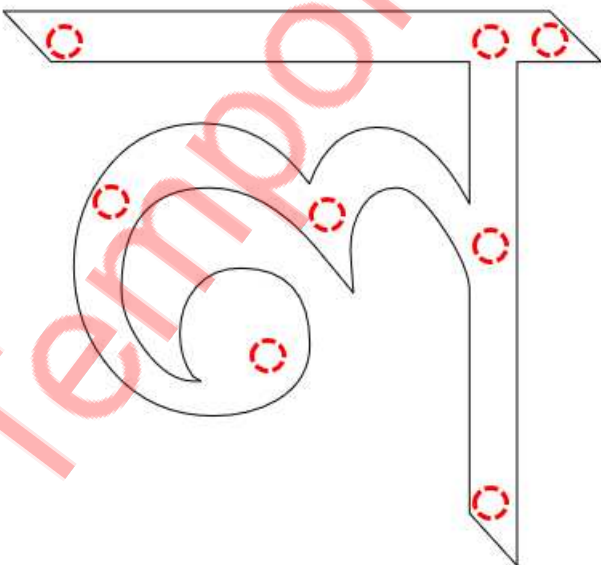

Student Name: _____

Verified By: _____

Class: _____

Date: _____

Pick the Path Find the Correct Alphabet

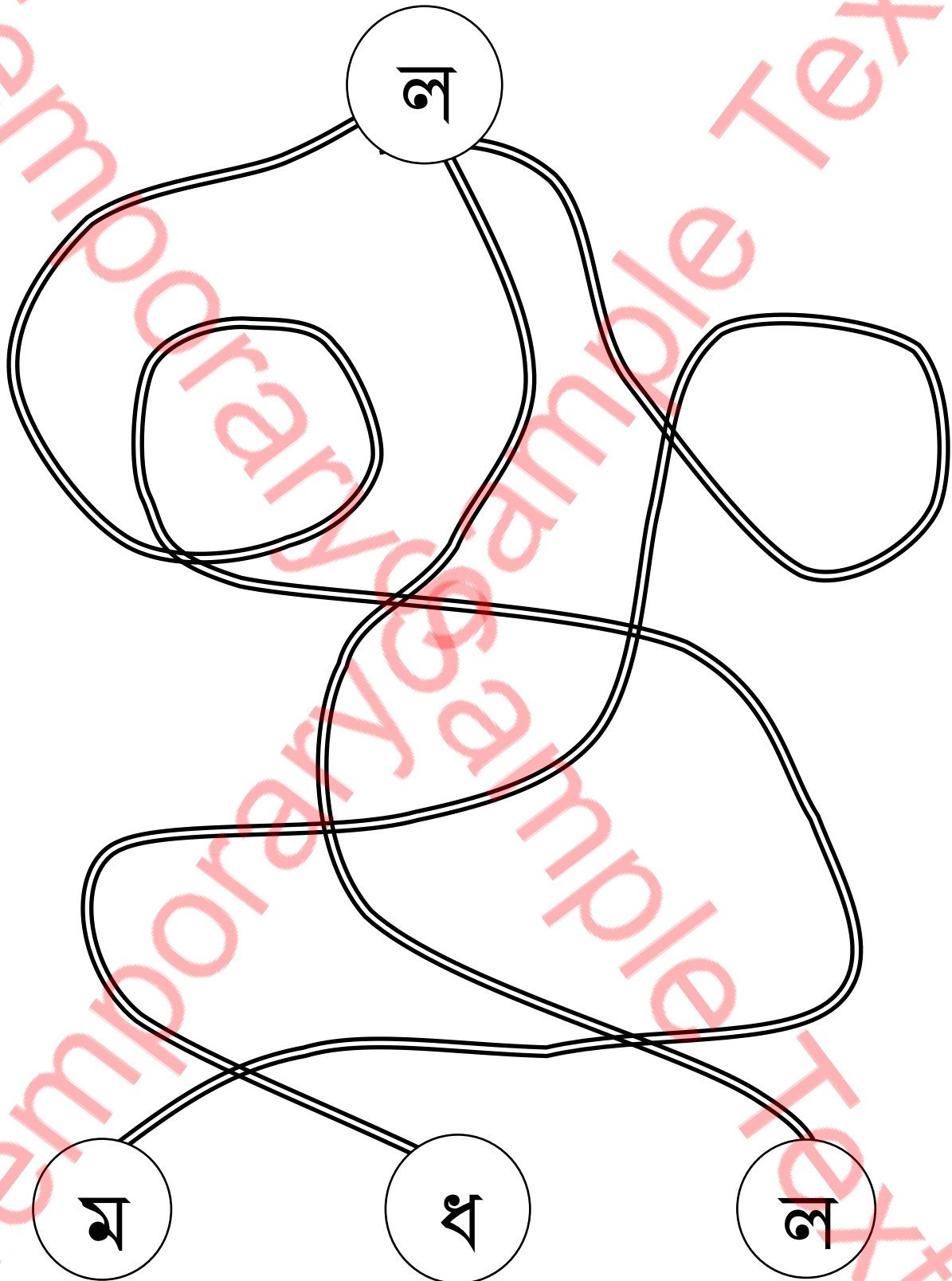

Student Name: _____

Verified By: _____

Class: _____

Date: _____

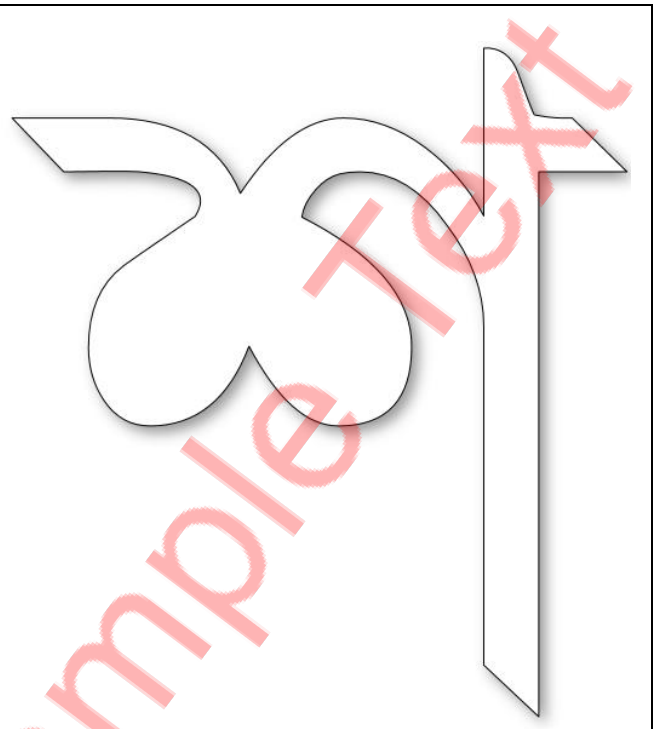
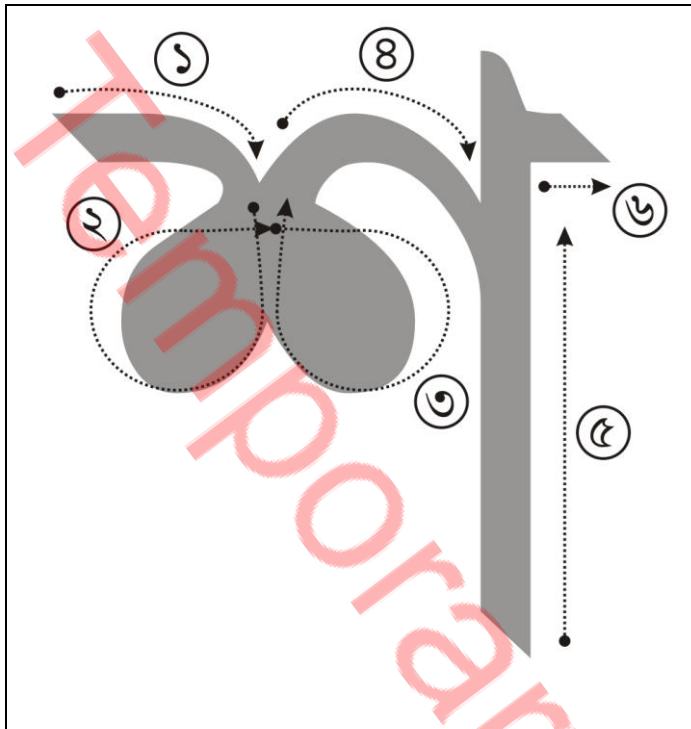

Follow the above steps

Colour it accordingly

ক	খ	গ	ঘ	ঙ	চ	ছ	জ
ঝ	ঞ	ট	ঠ	ড	ঢ	ণ	ত
থ	দ	ধ	ন	প	ফ	ব	ভ
ম	য	র	ল	শ	ষ	স	হ
ড়	ঢ়	য়	৐	৑	৒	৓	

Student Name: _____

Verified By: _____

Class: _____

Date: _____

Trace It

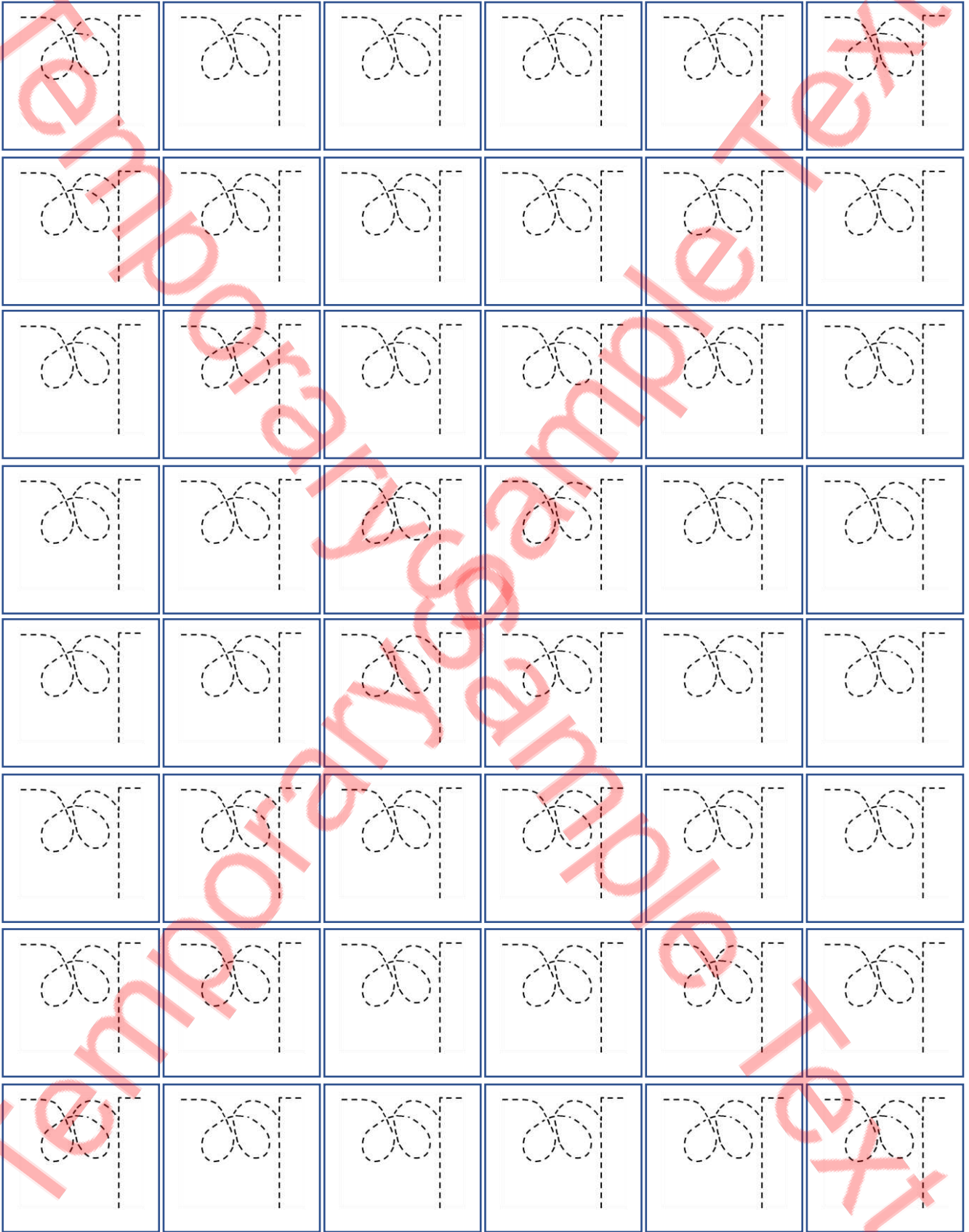

Student Name: _____

Verified By: _____

Class: _____

Date: _____

Trace it

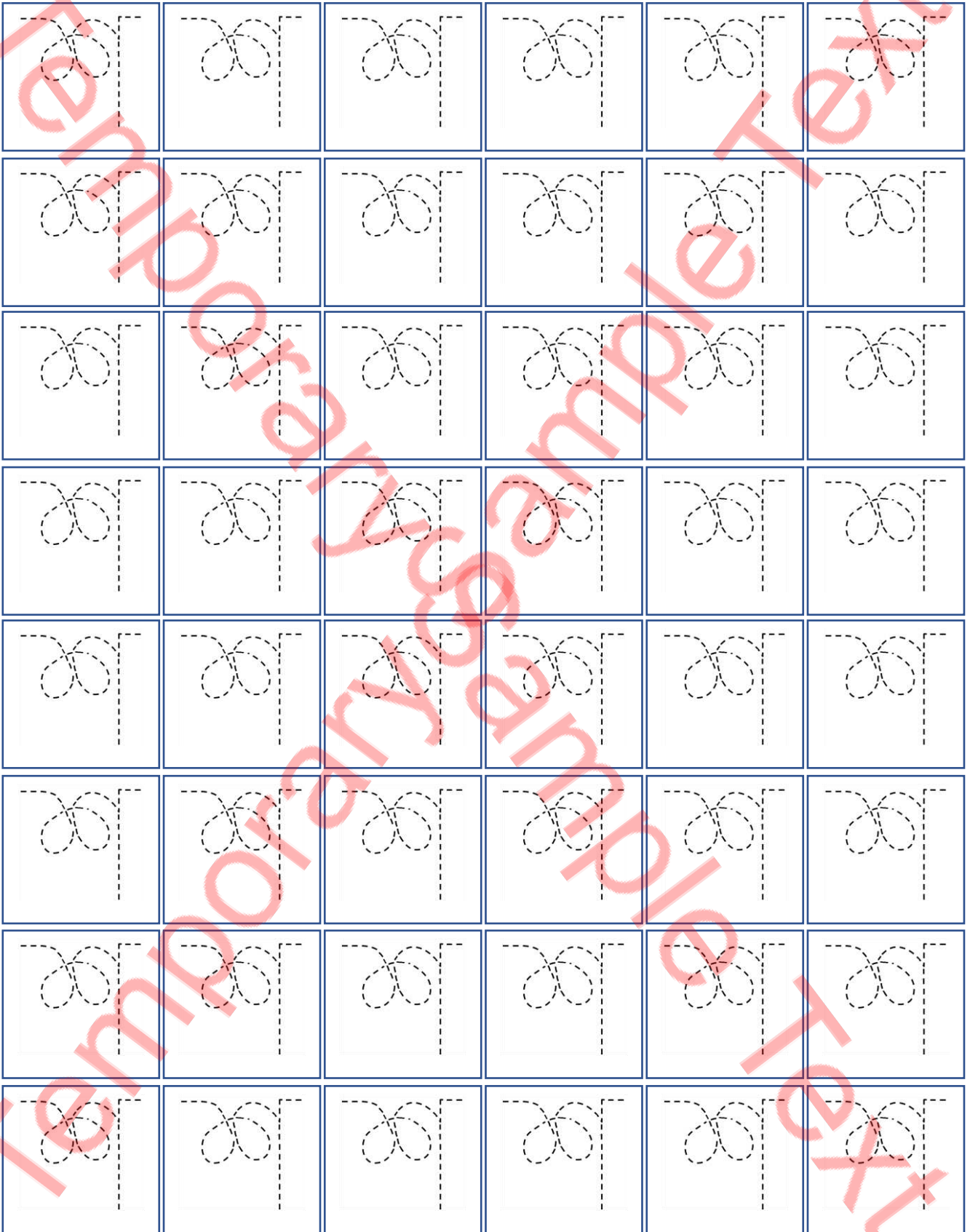

Student Name: _____

Verified By: _____

Class: _____

Date: _____

Write it

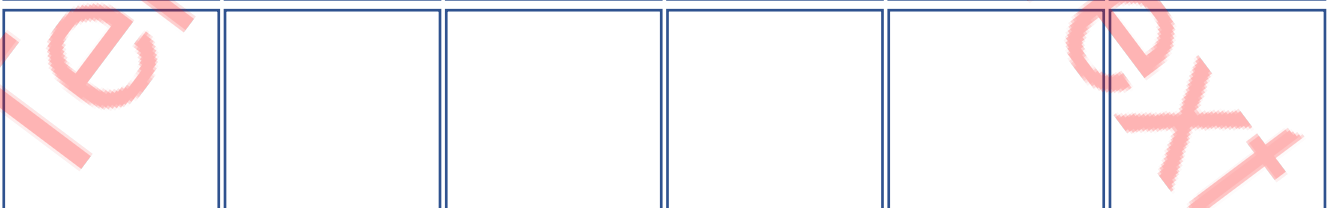
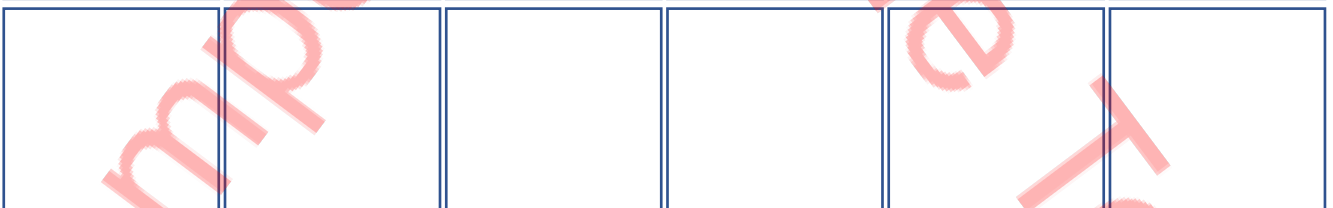
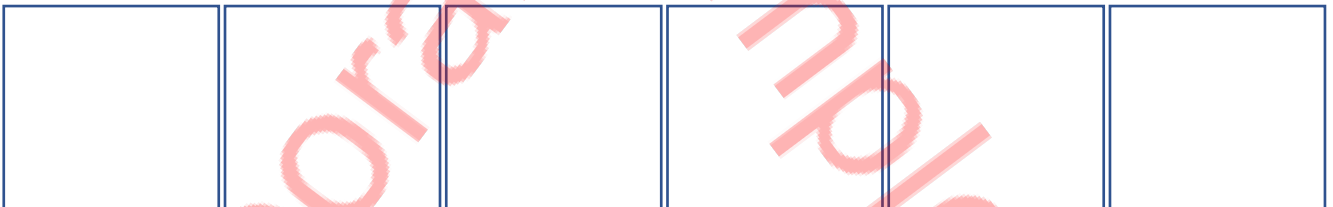
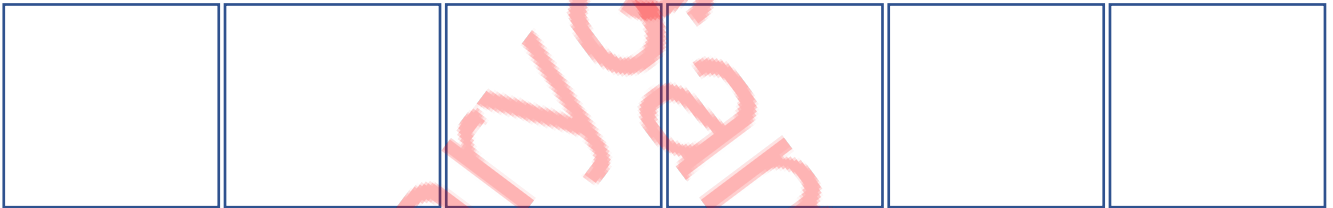
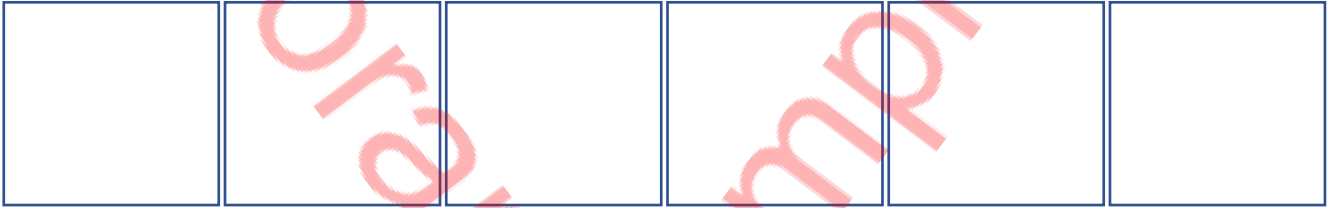
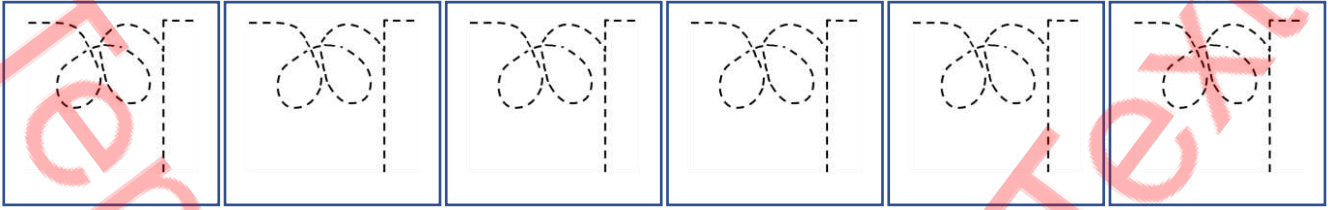

Student Name: _____

Verified By: _____

Class: _____

Date: _____

Copy Colour

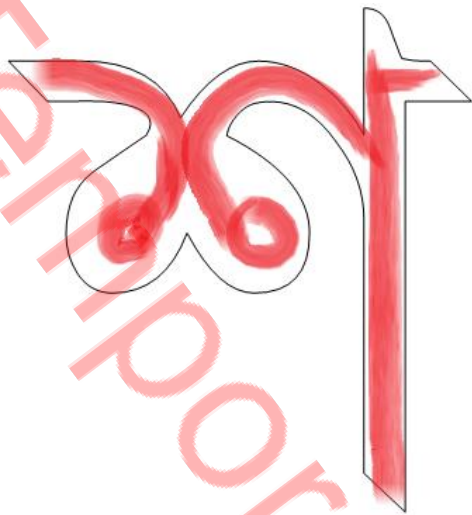

Colour it

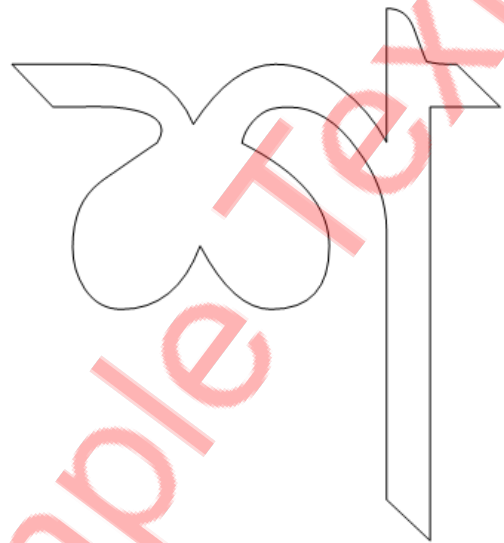

Write it

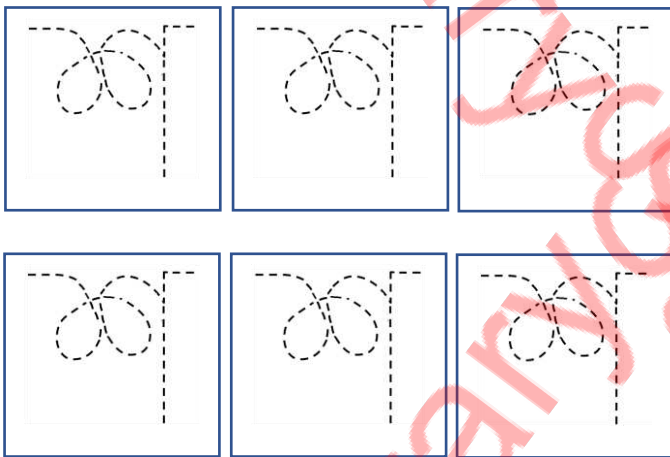

Find it

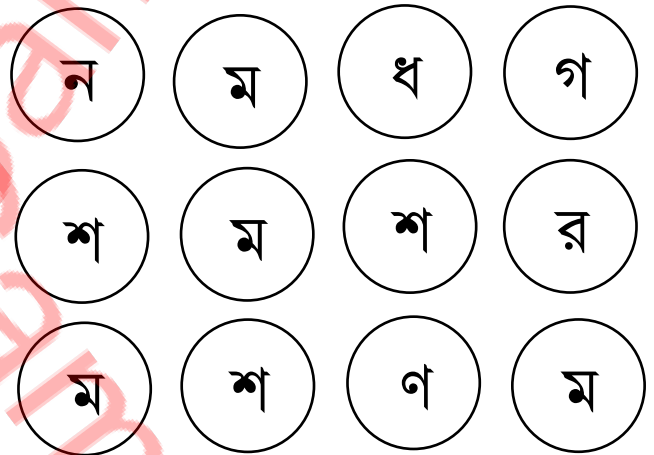

Connect the circle

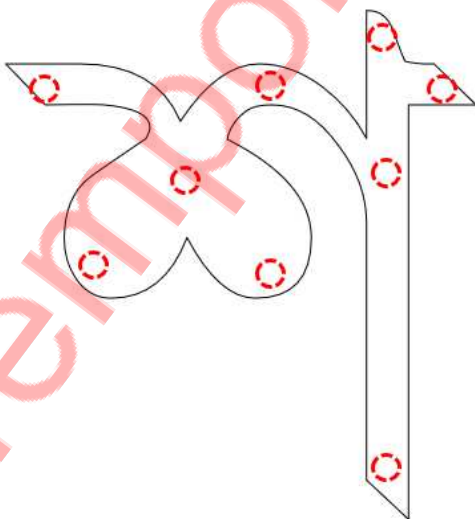

Do it

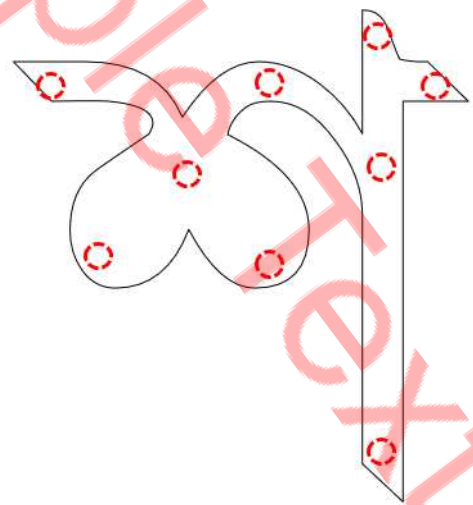

Student Name: _____

Verified By: _____

Class: _____

Date: _____

Pick the Path Find the Correct Alphabet

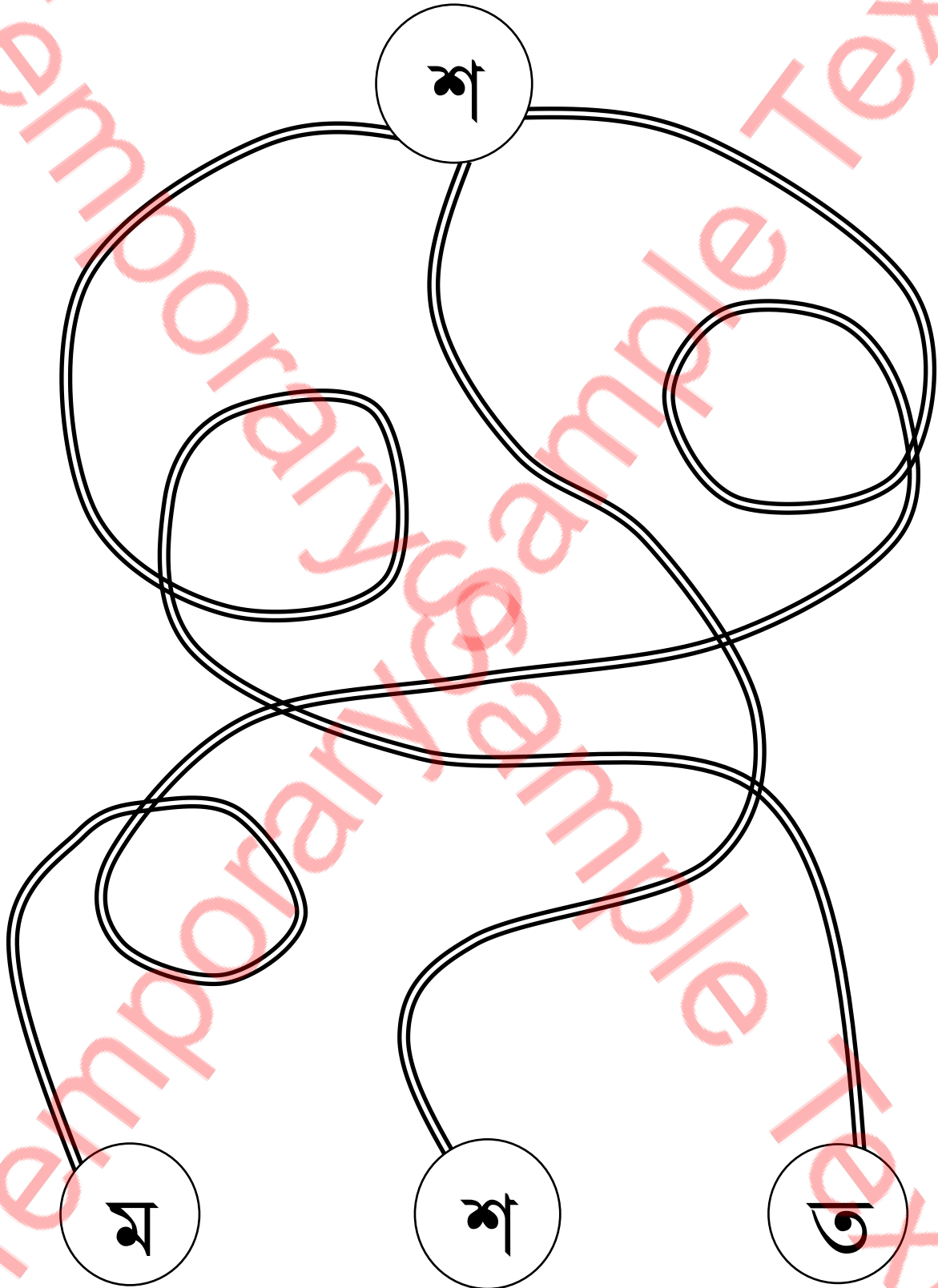

Student Name: _____

Verified By: _____

Class: _____

Date: _____

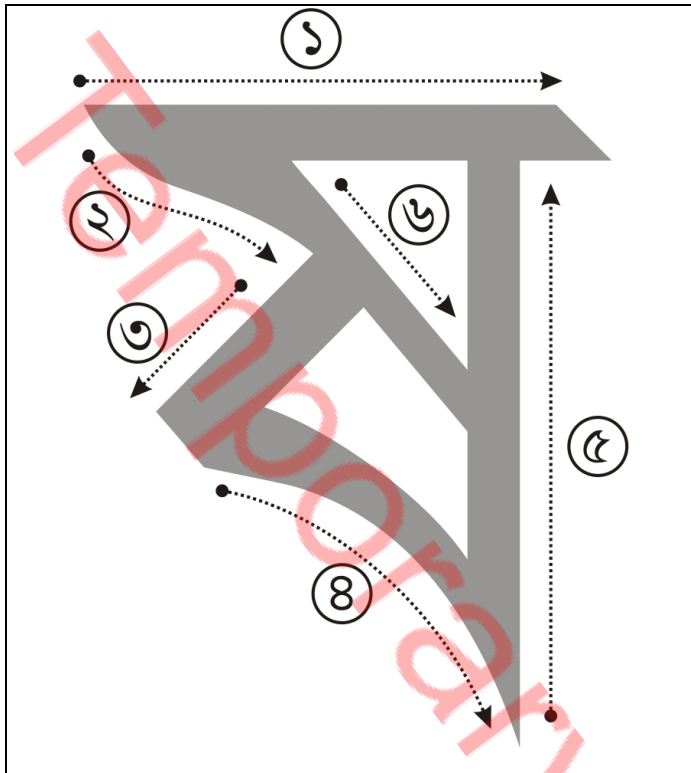

Follow the above steps

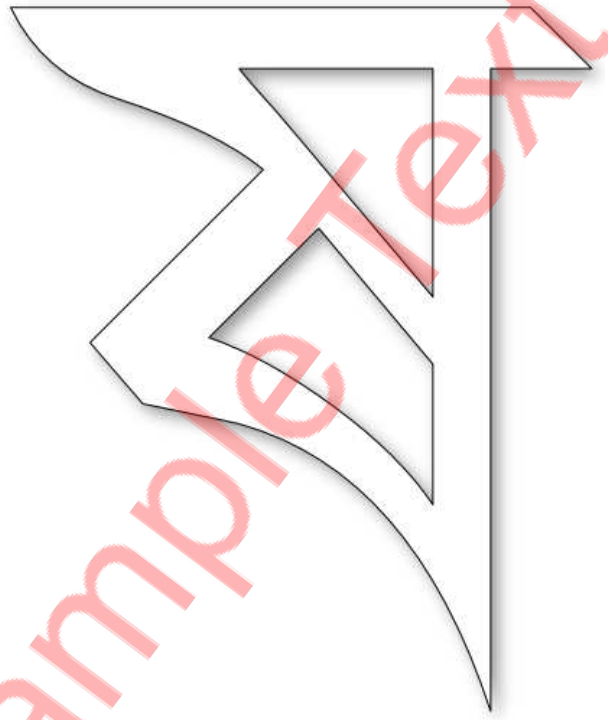

Colour it accordingly

ক	খ	গ	ঘ	ঙ	চ	ছ	জ
ঝ	ঞ	ট	ঠ	ড	ঢ	ণ	ত
থ	দ	ধ	ন	প	ফ	ব	ভ
ম	য	র	ল	শ	ষ	স	হ
ড়	ঢ়	য়	ৱ	৲	৳	৴	

Student Name: _____

Verified By: _____

Class: _____

Date: _____

Trace It



Student Name: _____

Verified By: _____

Class: _____

Date: _____

Trace it



Student Name: _____

Verified By: _____

Class: _____

Date: _____

Write it

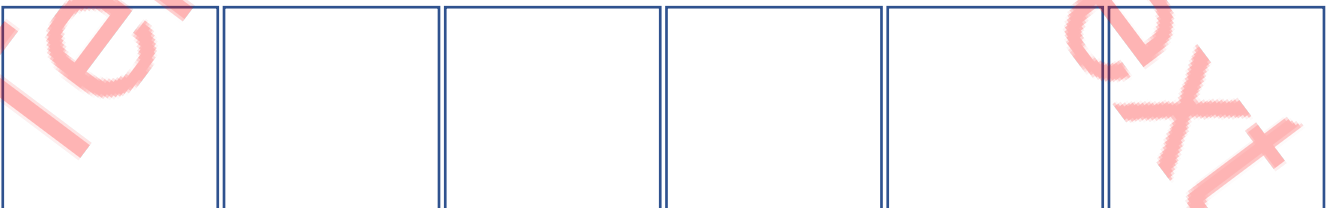
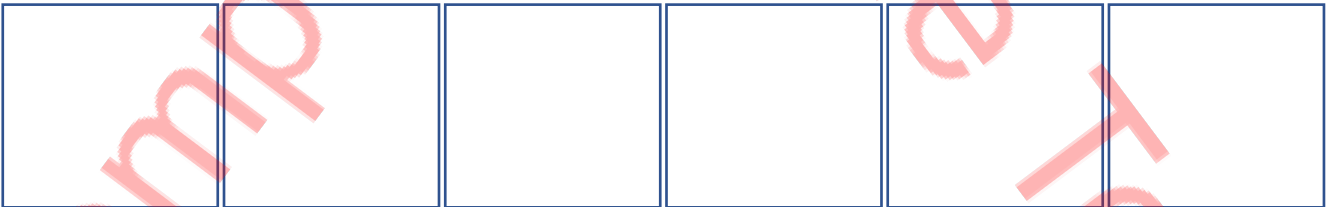
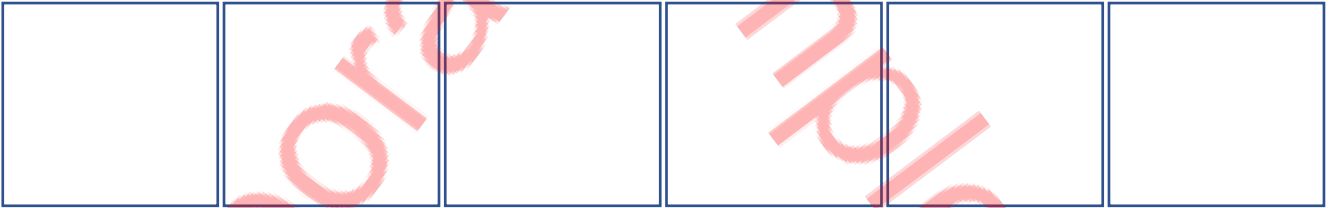
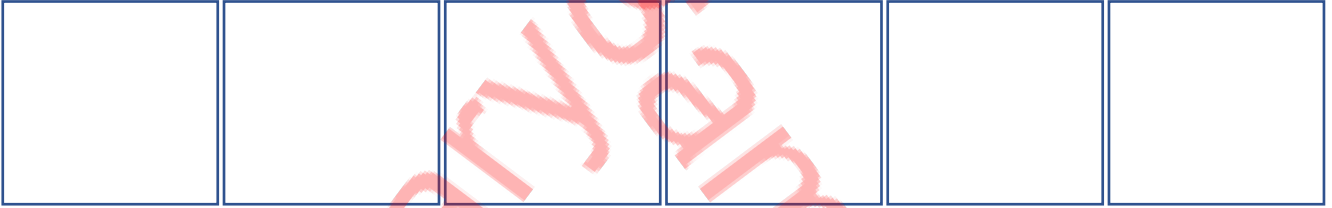
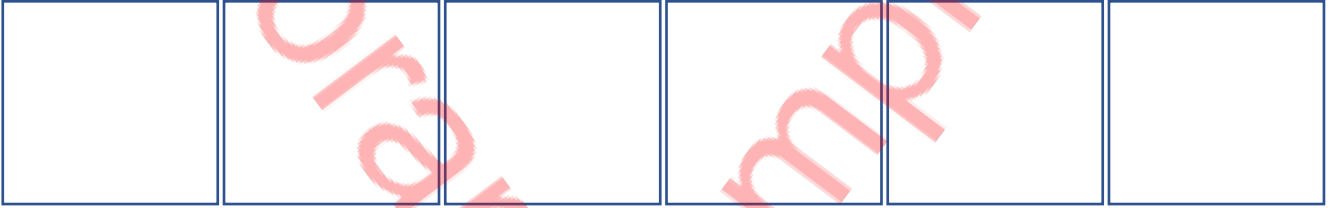
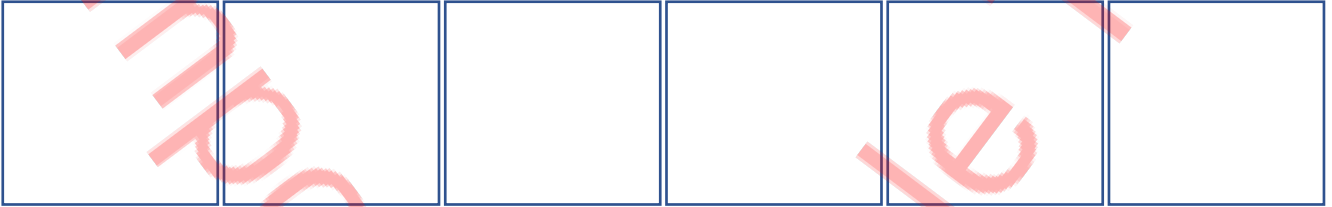
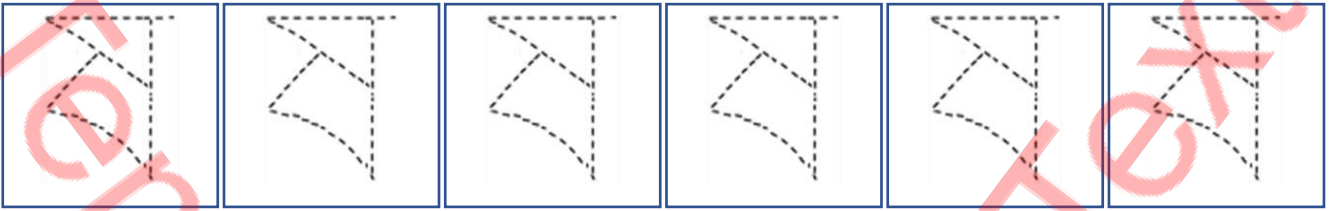

Student Name: _____

Verified By:

Class: _____

Date:

Copy Colour

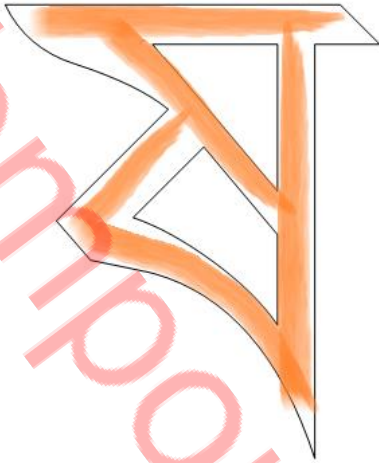

Colour it



Write it

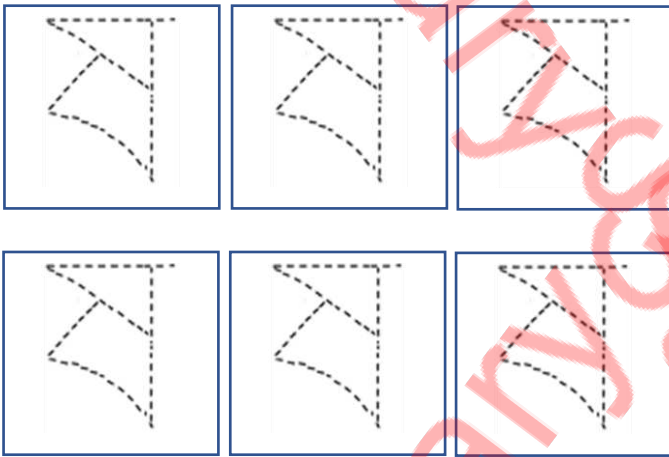

Find it

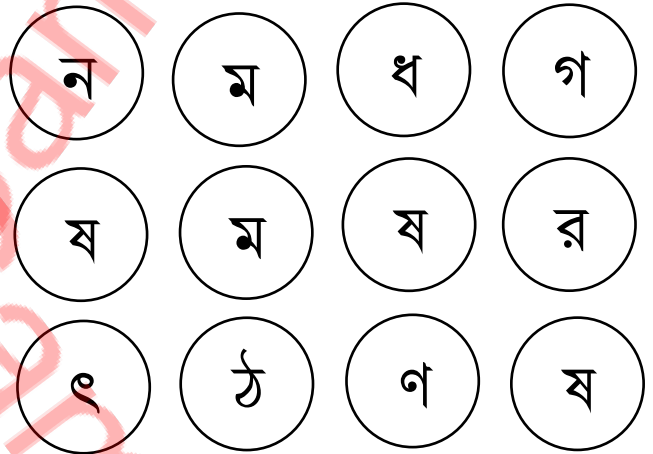

Connect the circle

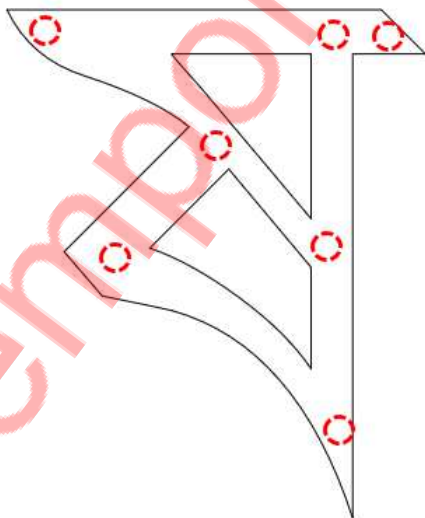

Do it

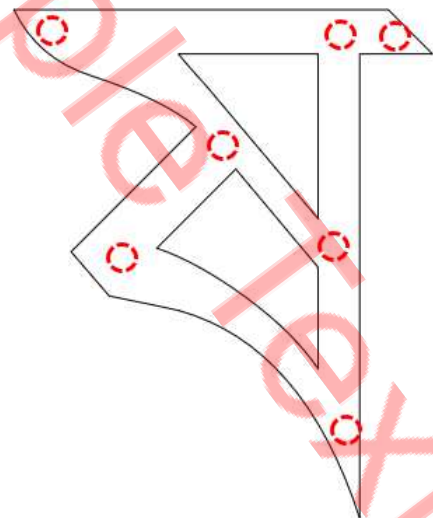

Student Name: _____

Verified By: _____

Class: _____

Date: _____

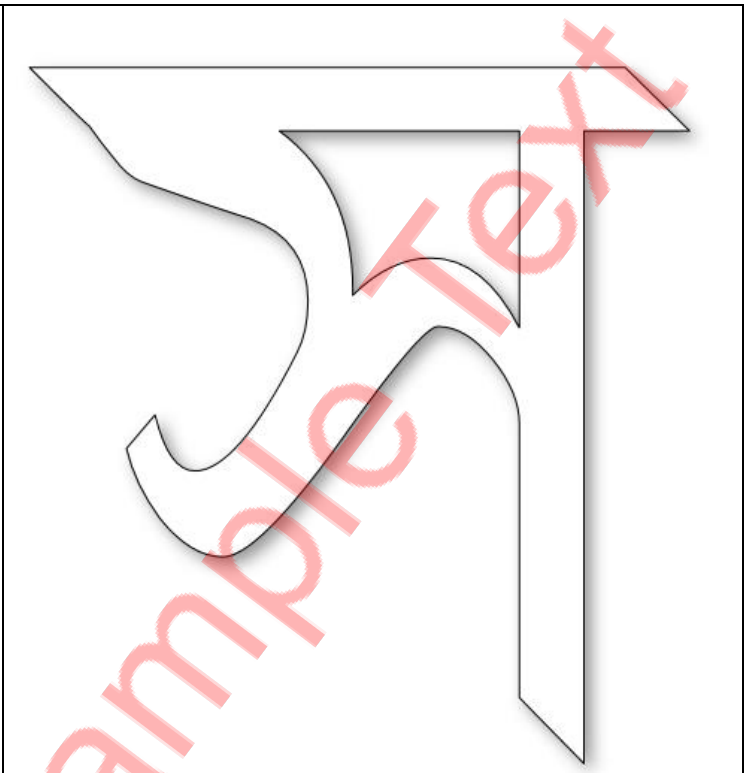
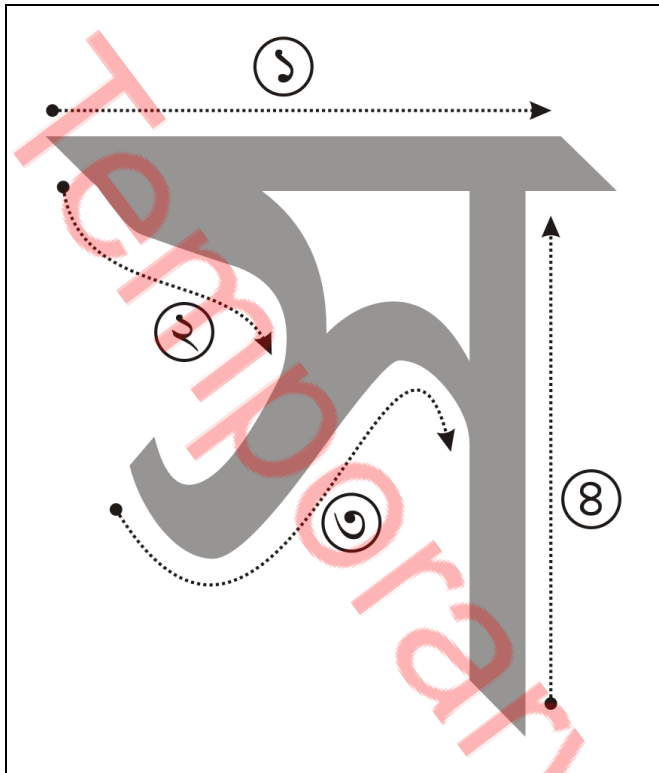

Follow the above steps

Colour it accordingly

ক	খ	গ	ঘ	ঙ	চ	ছ	জ
ঝ	ঞ	ট	ঠ	ড	ঢ	ণ	ত
থ	দ	ধ	ন	প	ফ	ব	ভ
ম	য	র	ল	শ	ষ	স	হ
ড়	ঢ়	য়	ৎ	ৎ	ঃ	ৎ	

Student Name: _____

Verified By: _____

Class: _____

Date: _____

Trace It

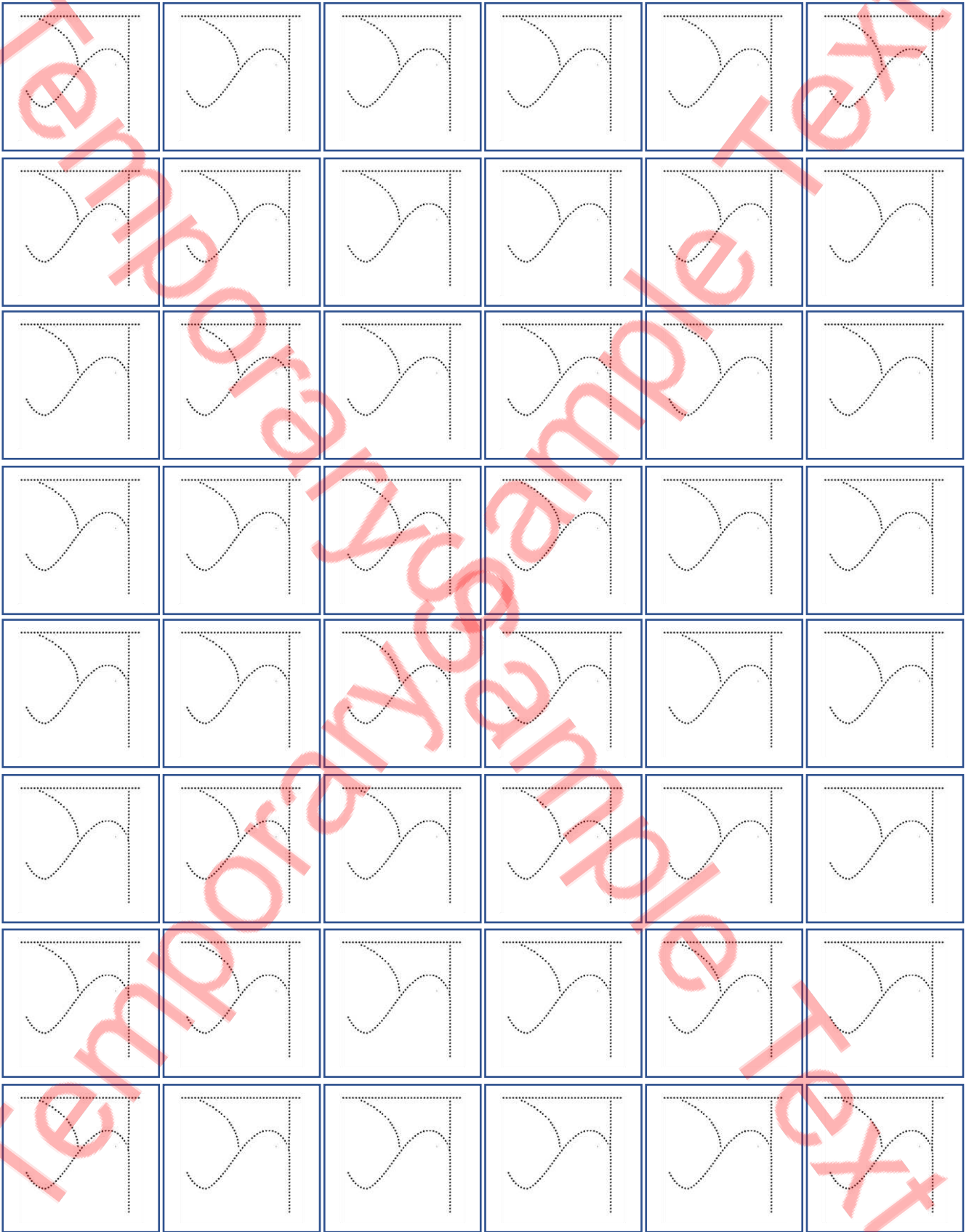

Student Name: _____

Verified By: _____

Class: _____

Date: _____

Trace it

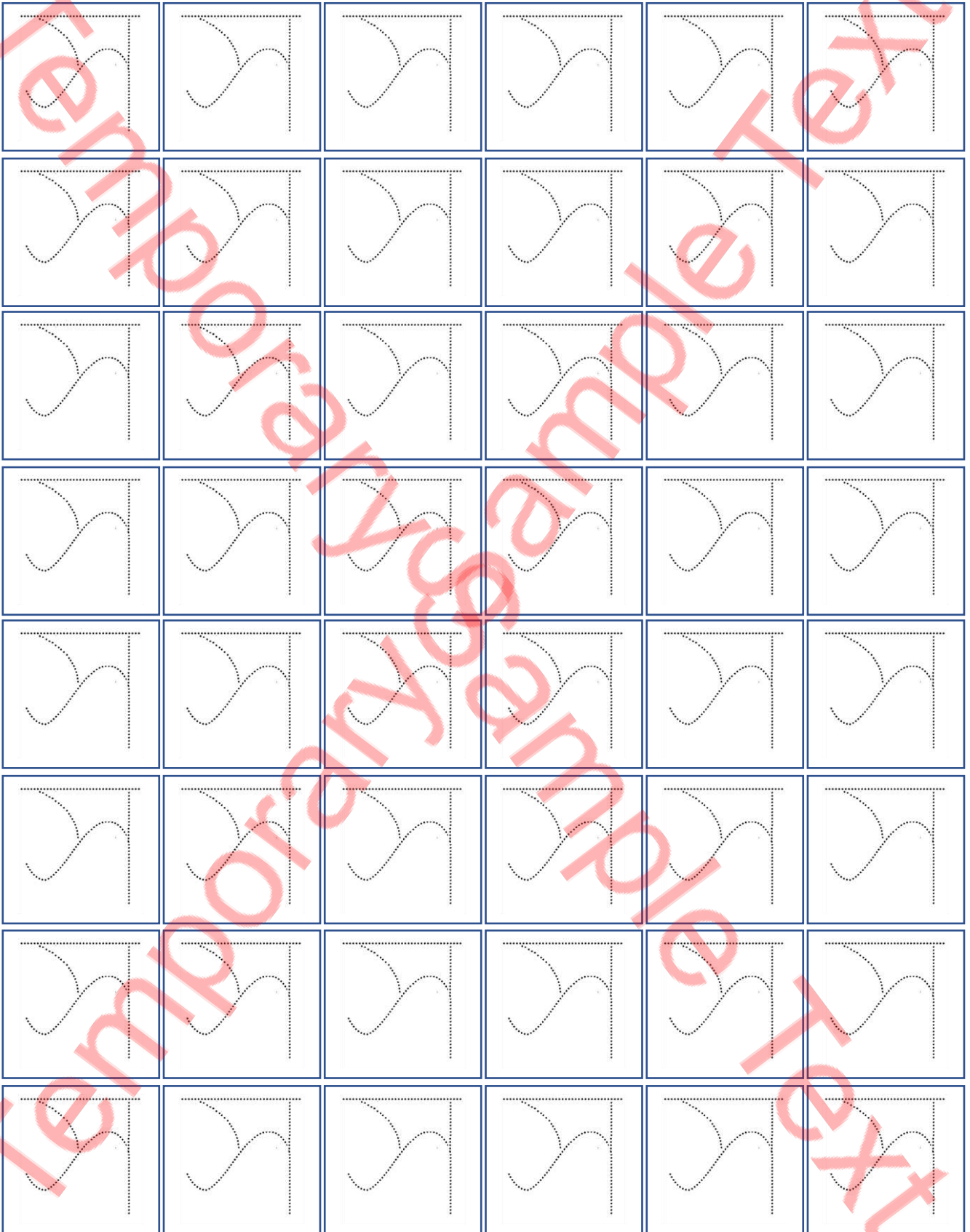

Student Name: _____

Verified By: _____

Class: _____

Date: _____

Write it

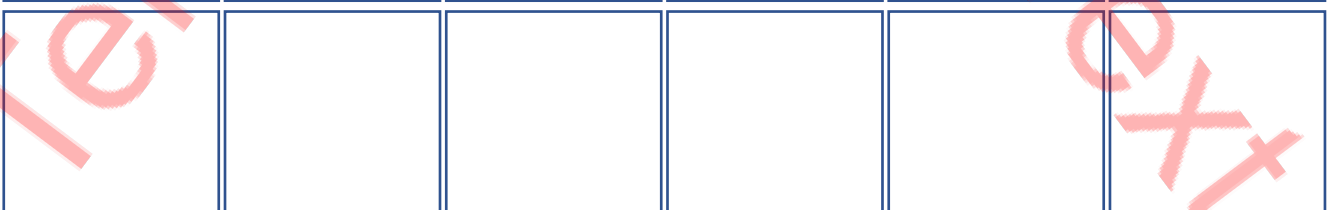
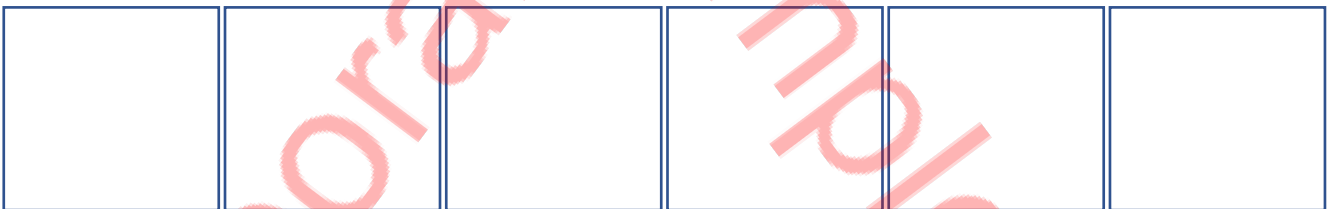
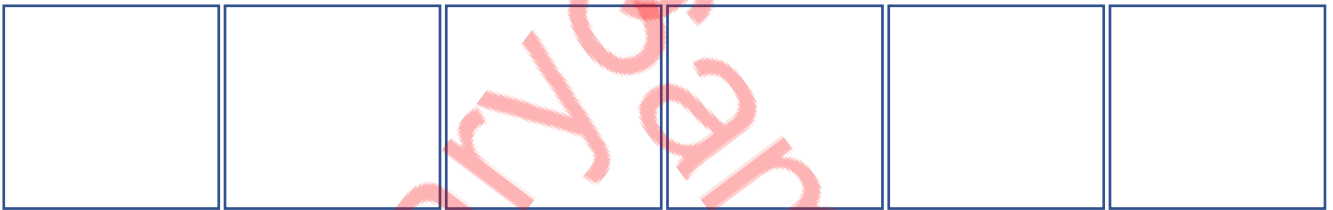
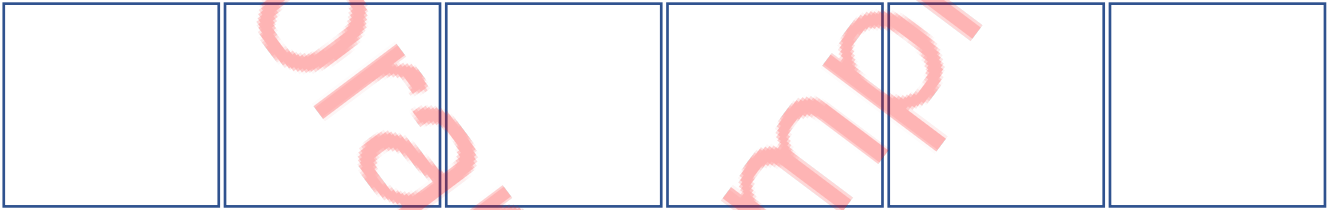
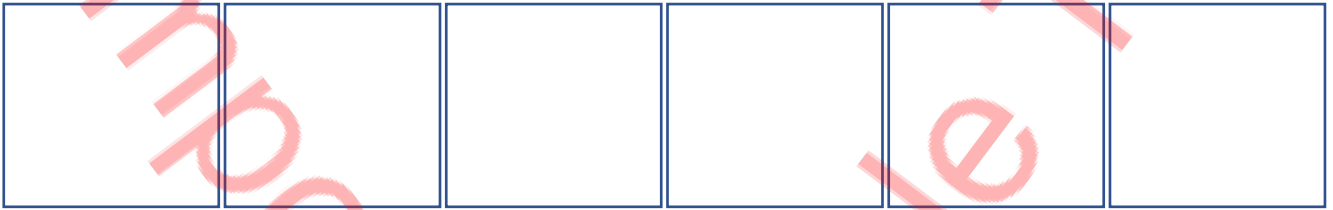
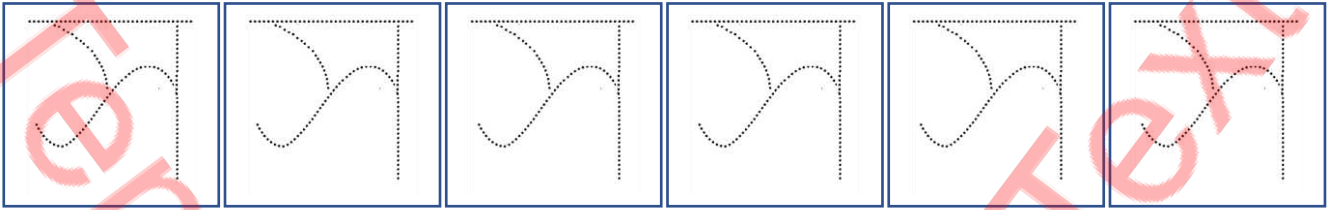

Student Name: _____

Verified By: _____

Class: _____

Date: _____

Copy Colour

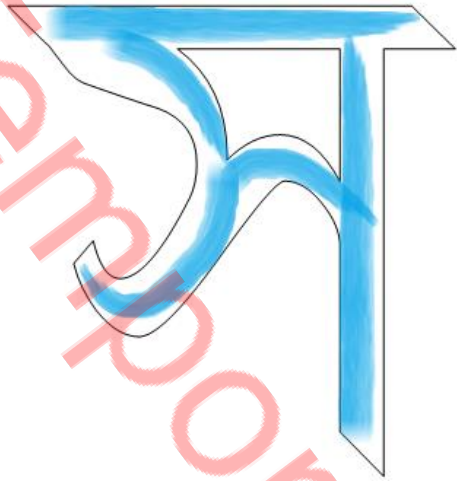

Colour it

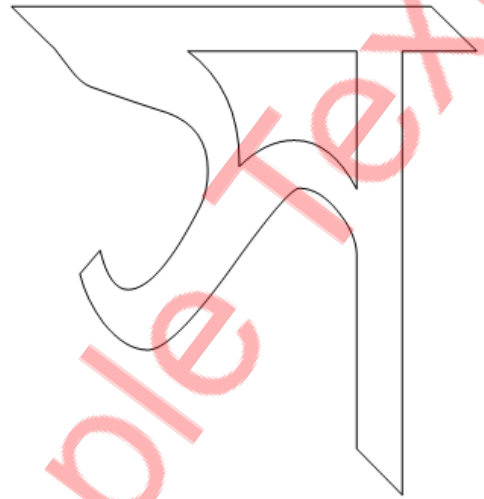

Write it

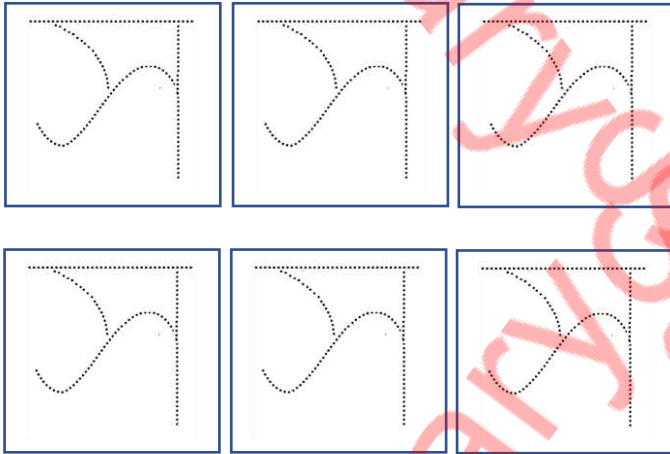

Find it

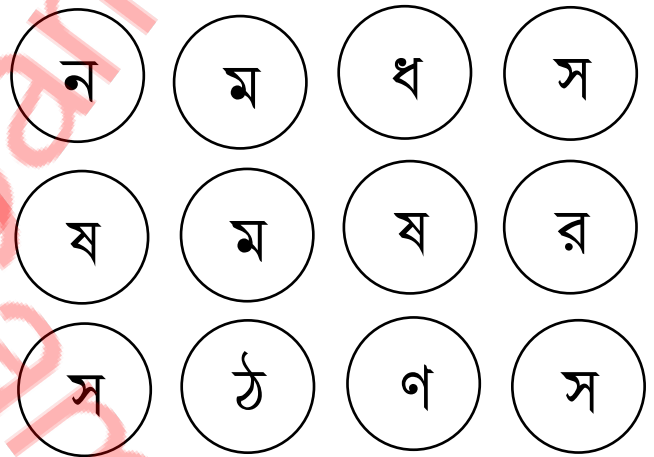

Connect the circle

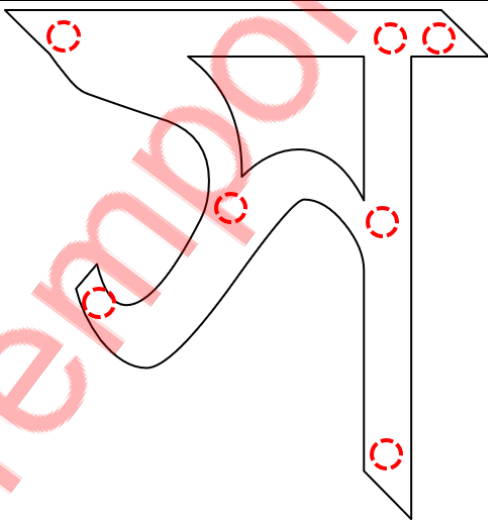

Do it

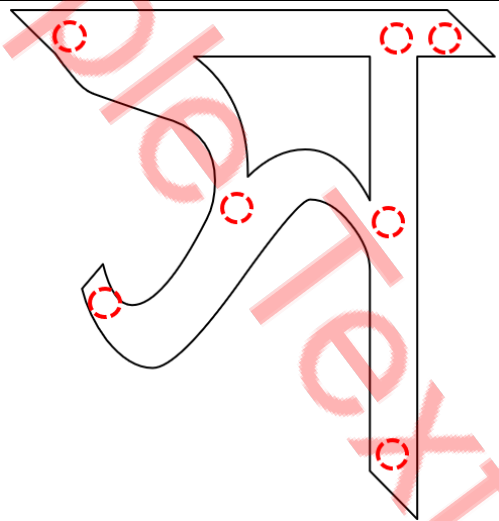

Student Name: _____

Verified By: _____

Class: _____

Date: _____

Pick the Path Find the Correct Alphabet

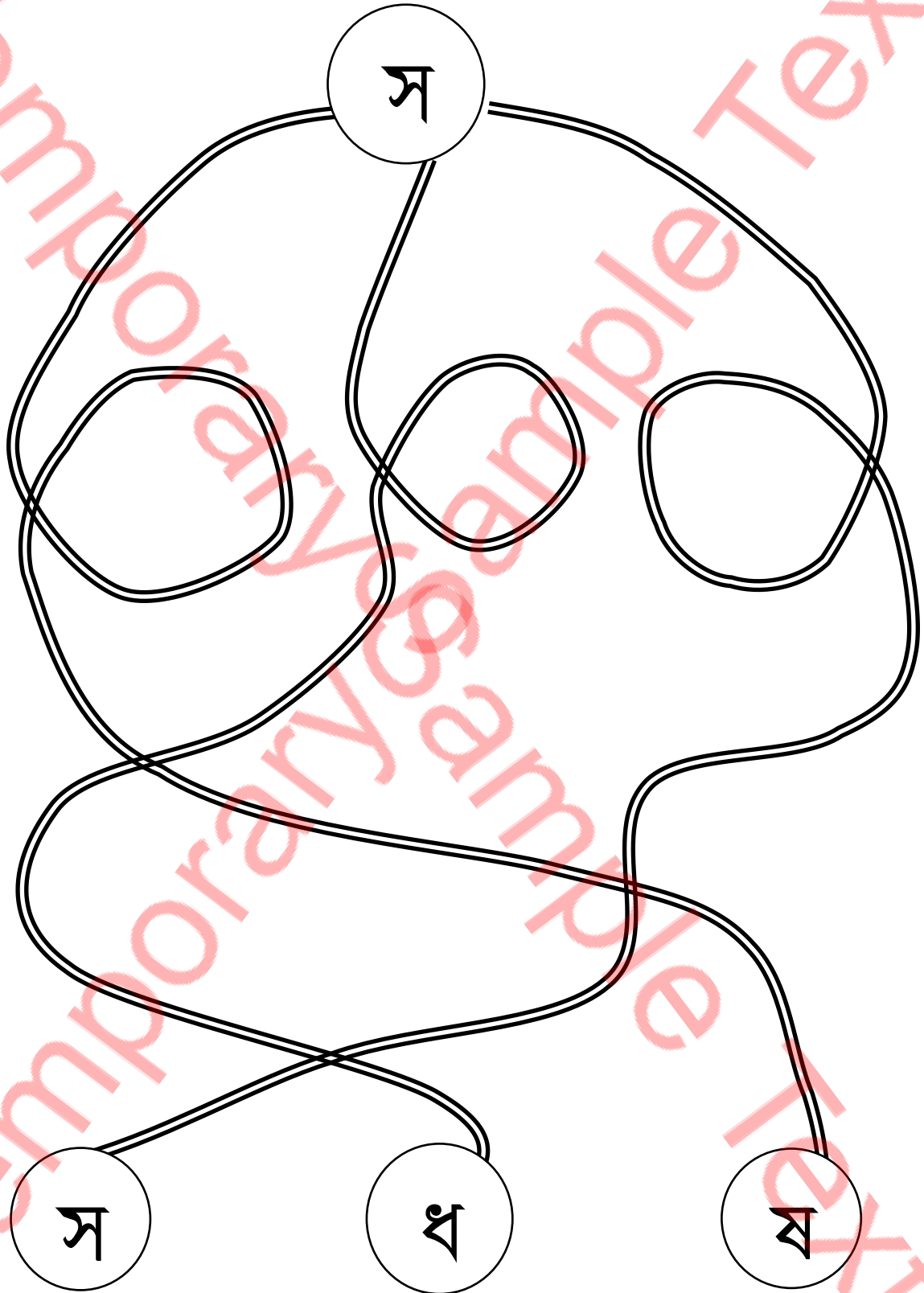

Student Name: _____

Verified By: _____

Class: _____

Date: _____

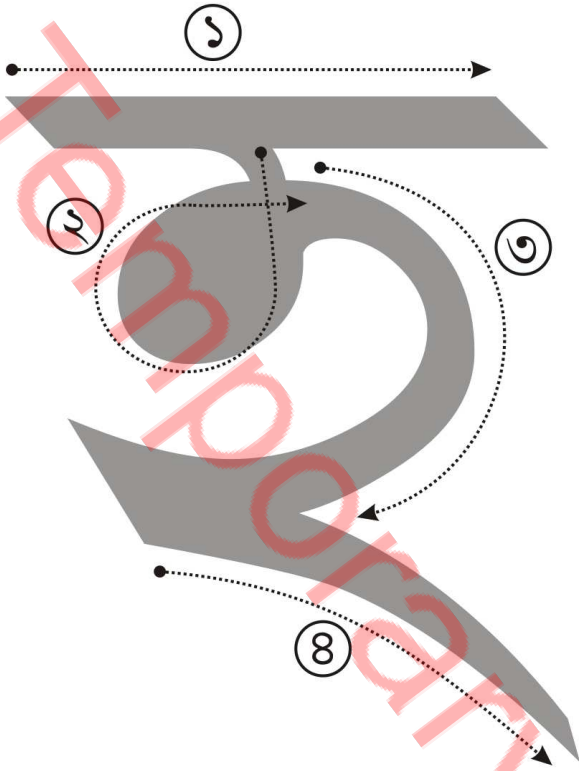

Follow the above steps

Colour it accordingly

ক	খ	গ	ঘ	ঙ	চ	ছ	জ
ঝ	ঞ	ট	ঠ	ড	ঢ	ণ	ত
থ	দ	ধ	ন	প	ফ	ব	ভ
ম	য	র	ল	শ	ষ	স	হ
ড়	ঢ়	য়	ৱ	৲	৳	৴	

Student Name: _____

Verified By: _____

Class: _____

Date: _____

Trace It



Student Name: _____

Verified By: _____

Class: _____

Date: _____

Trace it



Student Name: _____

Verified By: _____

Class: _____

Date: _____

Write it

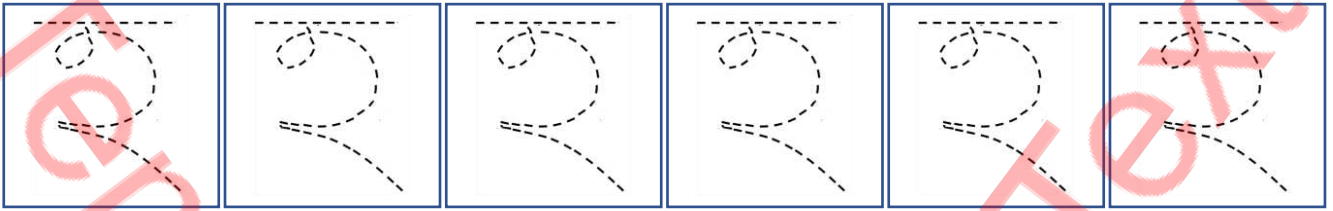

Student Name: _____

Verified By: _____

Class: _____

Date: _____

Copy Colour

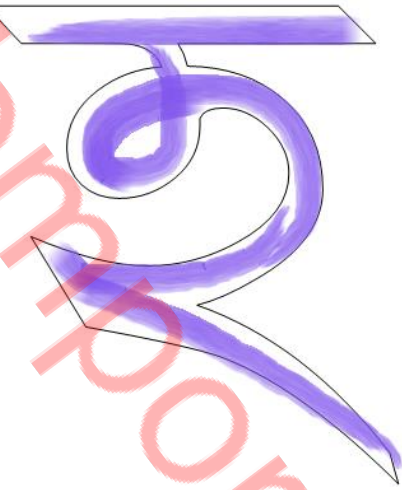

Colour it

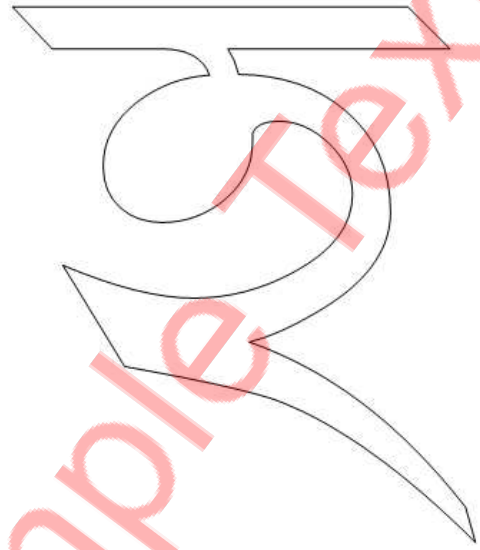

Write it

Find it

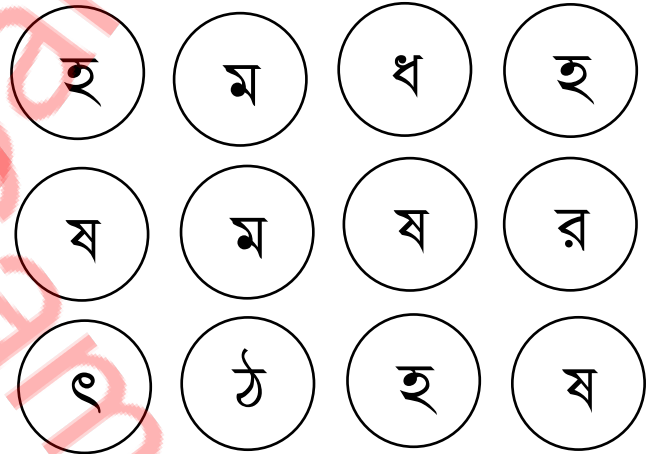
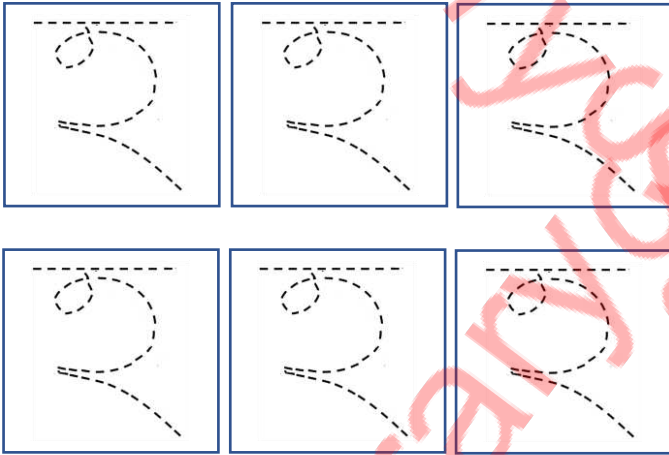

Connect the circle

Do it

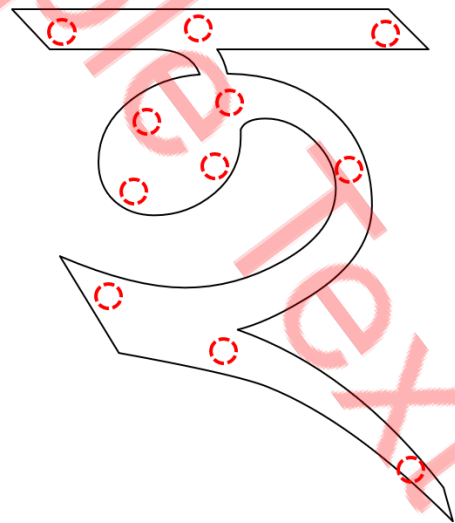
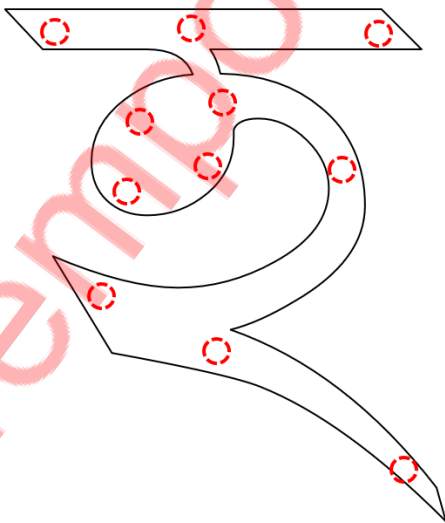

Student Name: _____

Verified By: _____

Class: _____

Date: _____

Pick the Path Find the Correct Alphabet

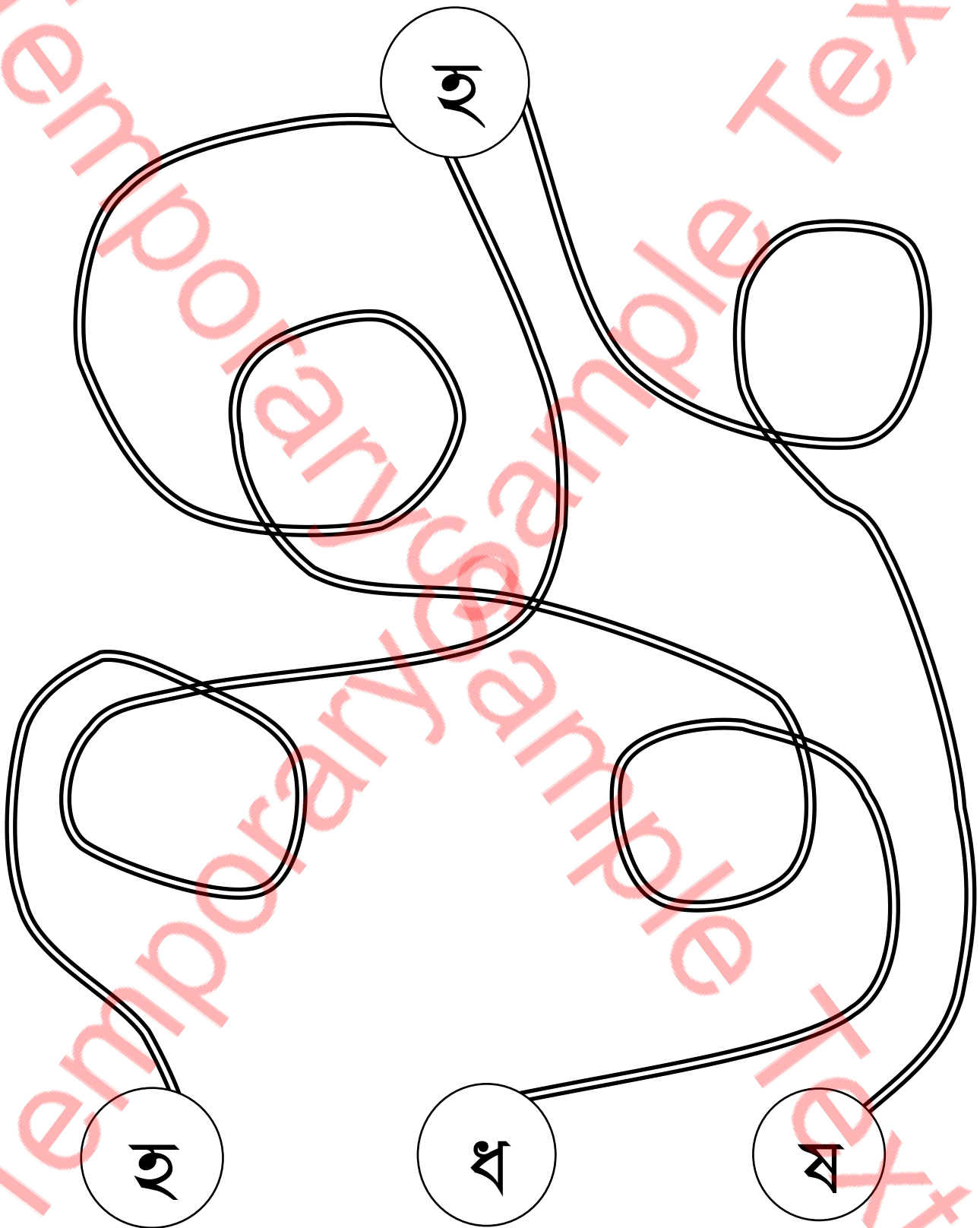

Student Name: _____

Verified By: _____

Class: _____

Date: _____

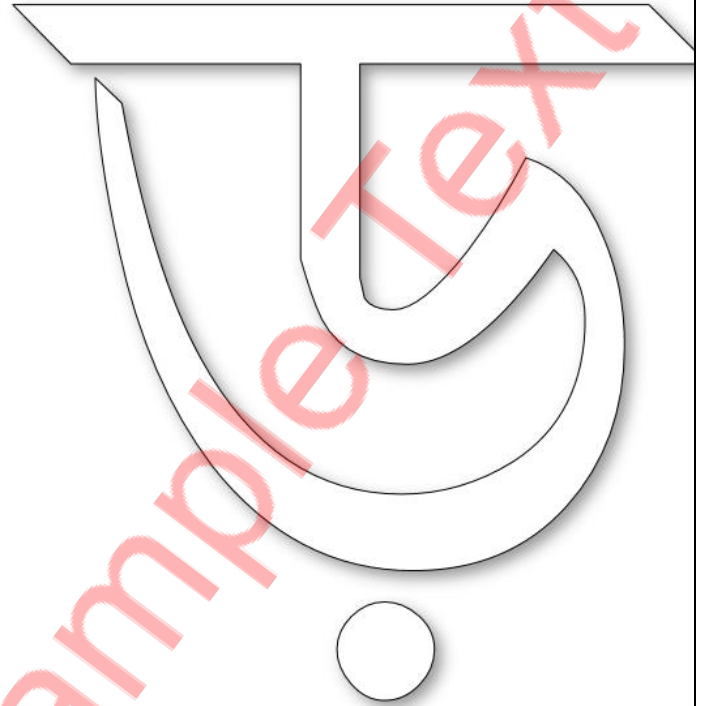
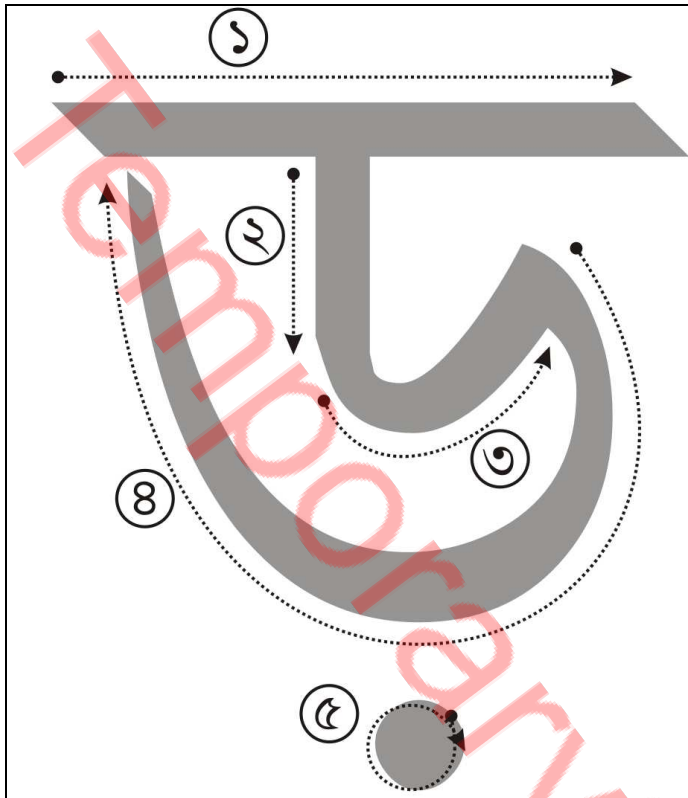

Follow the above steps

Colour it accordingly

ক	খ	গ	ঘ	ঙ	চ	ছ	জ
ঝ	ঞ	ট	ঠ	ড	ঢ	ণ	ত
থ	দ	ধ	ন	প	ফ	ব	ভ
ম	য	র	ল	শ	ষ	স	হ
ড়	ঢ়	য়	ৱ	ূ	ৃ	ৄ	

Student Name: _____

Verified By: _____

Class: _____

Date: _____

Trace It



Student Name: _____

Verified By: _____

Class: _____

Date: _____

Trace it



Student Name: _____

Verified By: _____

Class: _____

Date: _____

Write it

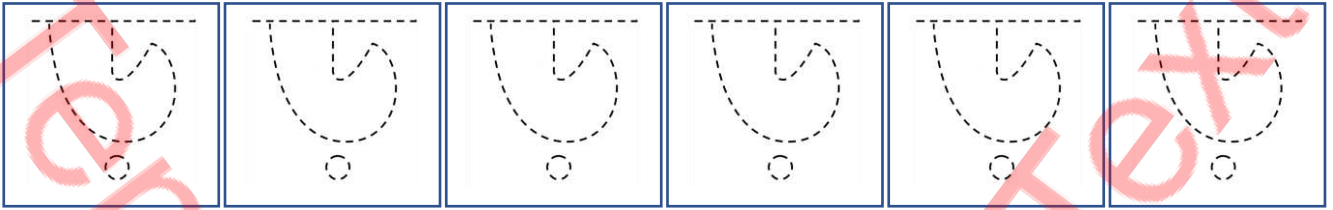

Student Name: _____

Verified By: _____

Class: _____

Date: _____

Copy Colour

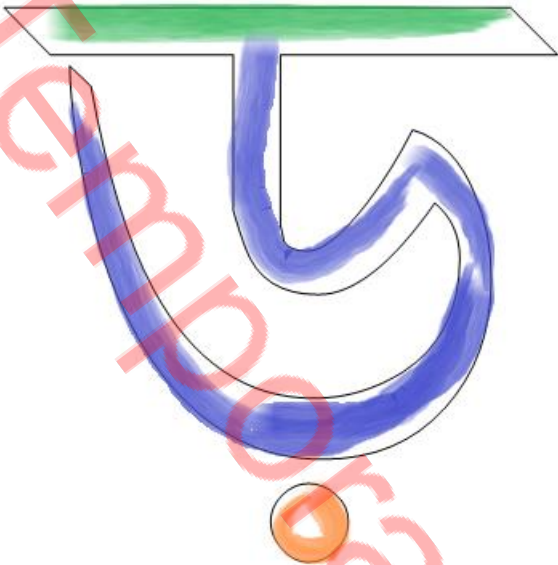

Colour it

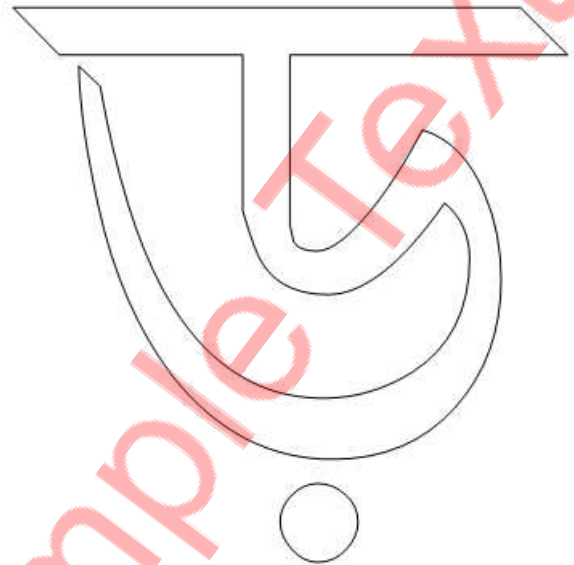

Write it

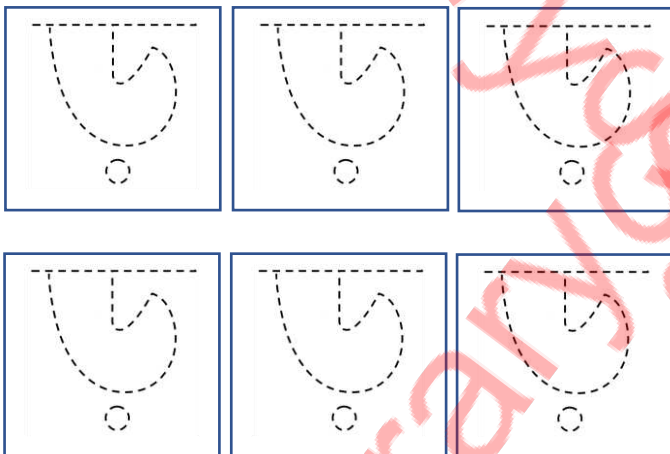

Find it

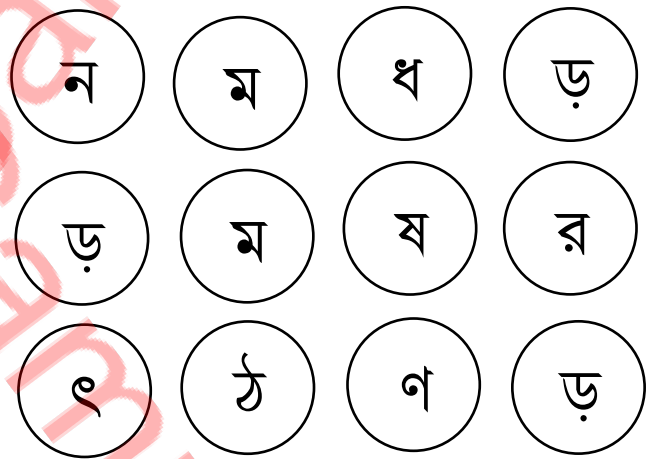

Connect the circle

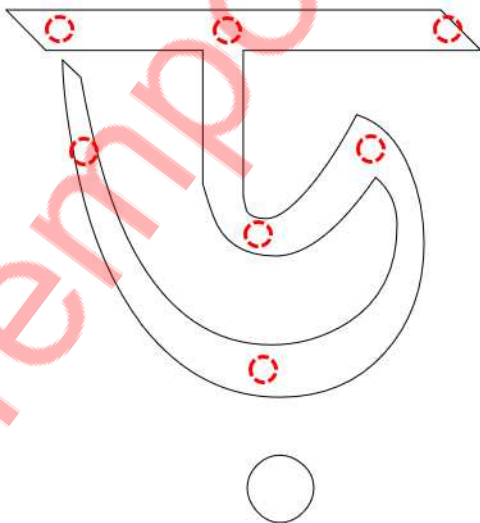

Do it

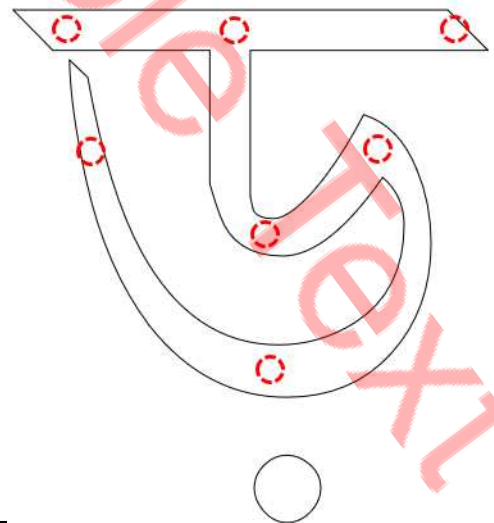

Student Name: _____

Verified By: _____

Class: _____

Date: _____

Pick the Path Find the Correct Alphabet

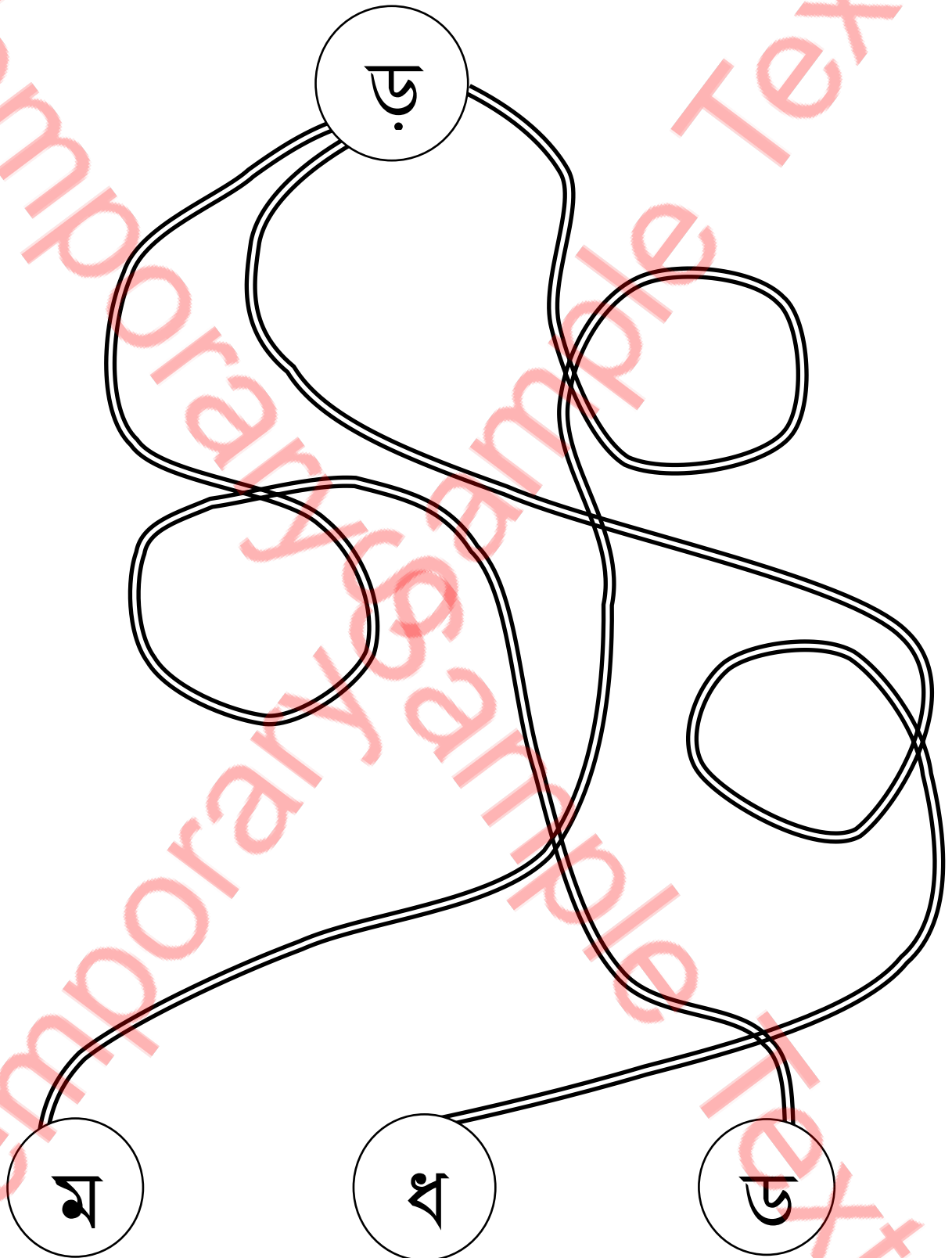

Student Name: _____

Verified By: _____

Class: _____

Date: _____

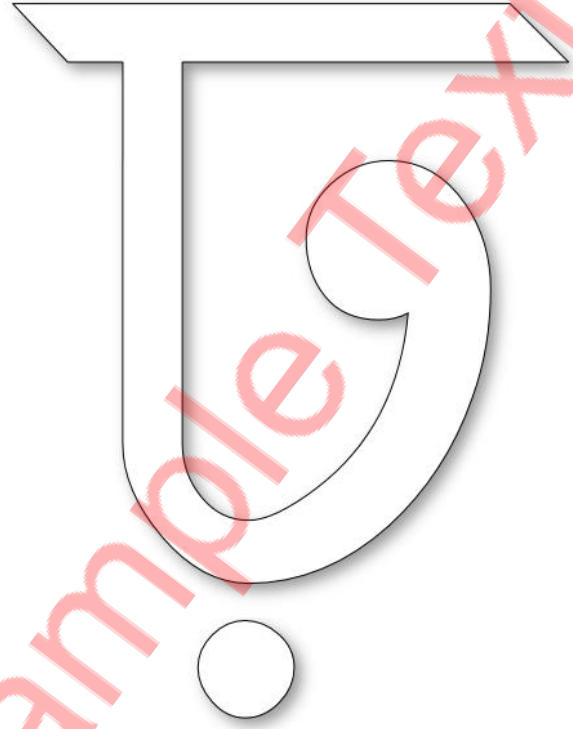
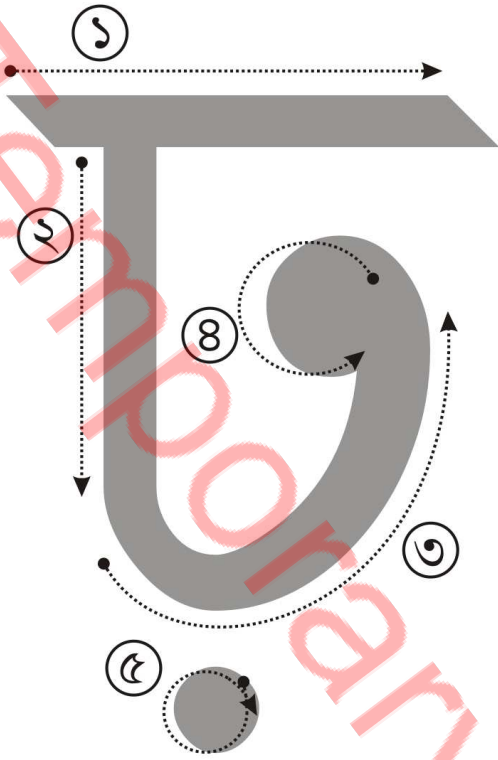

Follow the above steps

Colour it accordingly

ক	খ	গ	ঘ	ঙ	চ	ছ	জ
ঝ	ঞ	ট	ঠ	ড	ঢ	ণ	ত
থ	দ	ধ	ন	প	ফ	ব	ভ
ম	য	র	ল	শ	ষ	স	হ
ড়	ঢ়	য়	ৱ	৲	৳	৴	

Student Name: _____

Verified By: _____

Class: _____

Date: _____

Trace It



Student Name: _____

Verified By: _____

Class: _____

Date: _____

Trace it



Student Name: _____

Verified By: _____

Class: _____

Date: _____

Write it

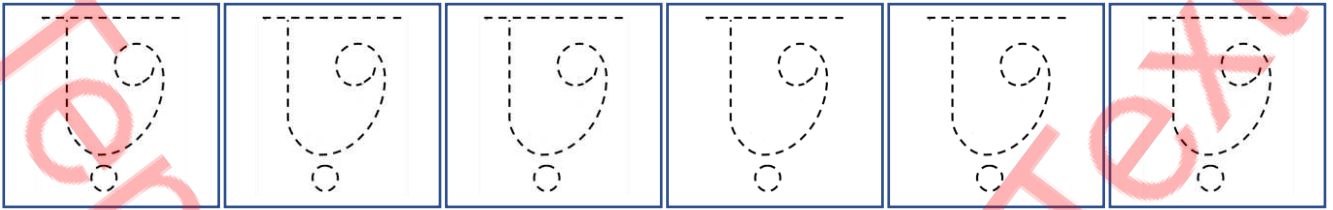

Student Name: _____

Verified By: _____

Class: _____

Date: _____

Copy Colour

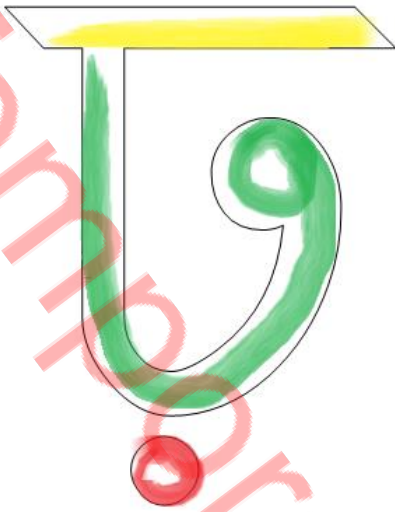

Colour it



Write it

Find it

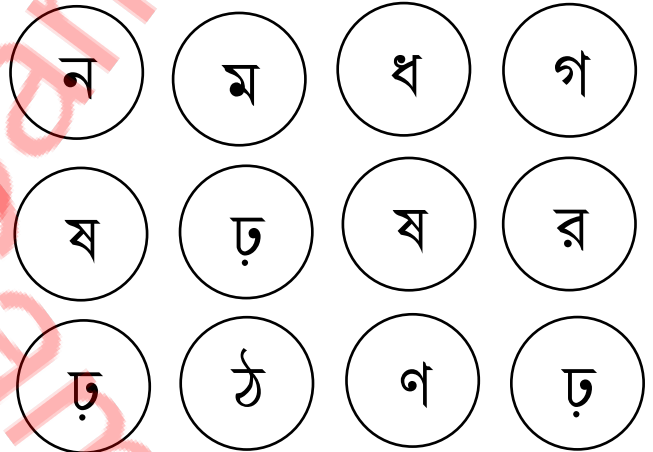
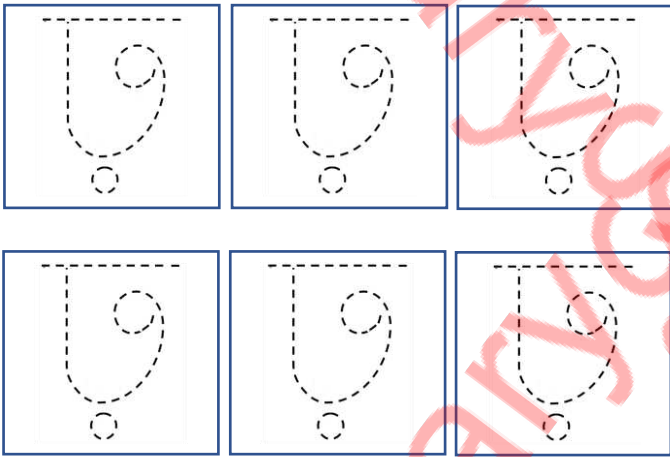

Connect the circle

Do it

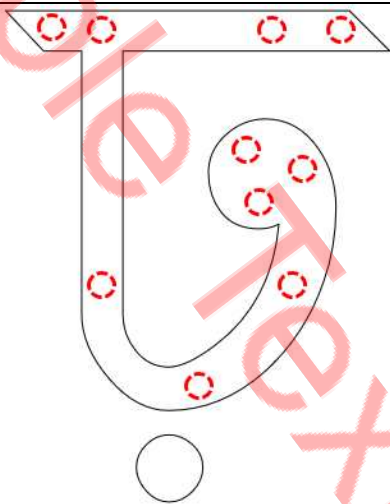
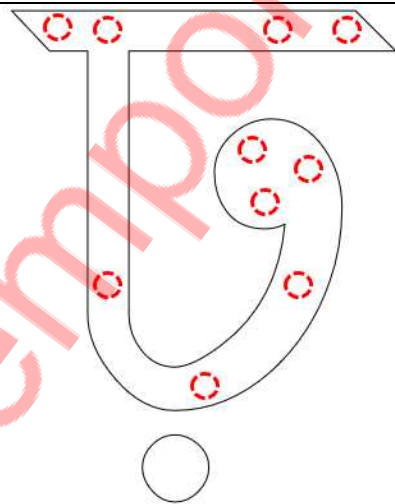

Student Name: _____

Verified By: _____

Class: _____

Date: _____

Pick the Path Find the Correct Alphabet

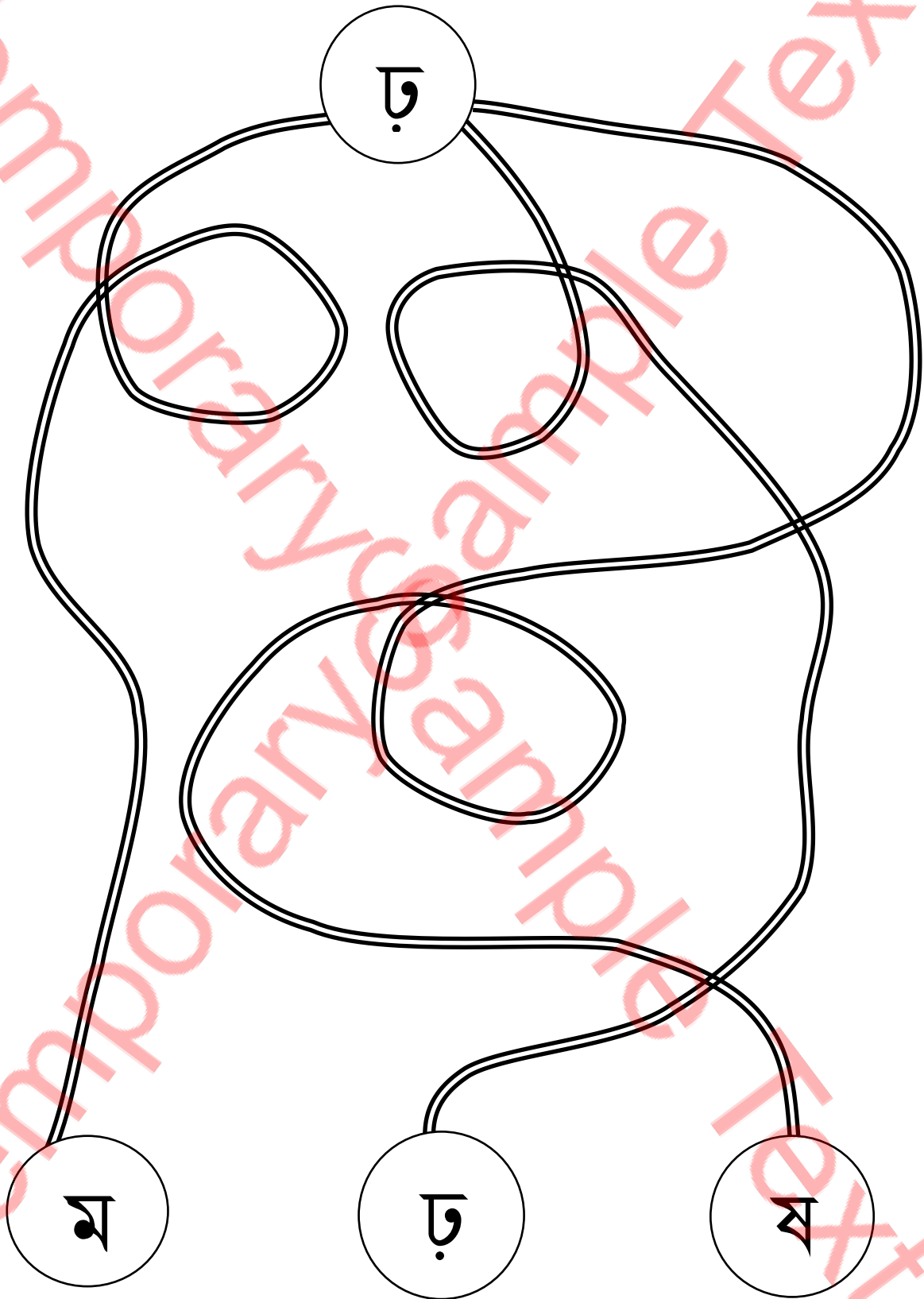

Student Name: _____

Verified By: _____

Class: _____

Date: _____

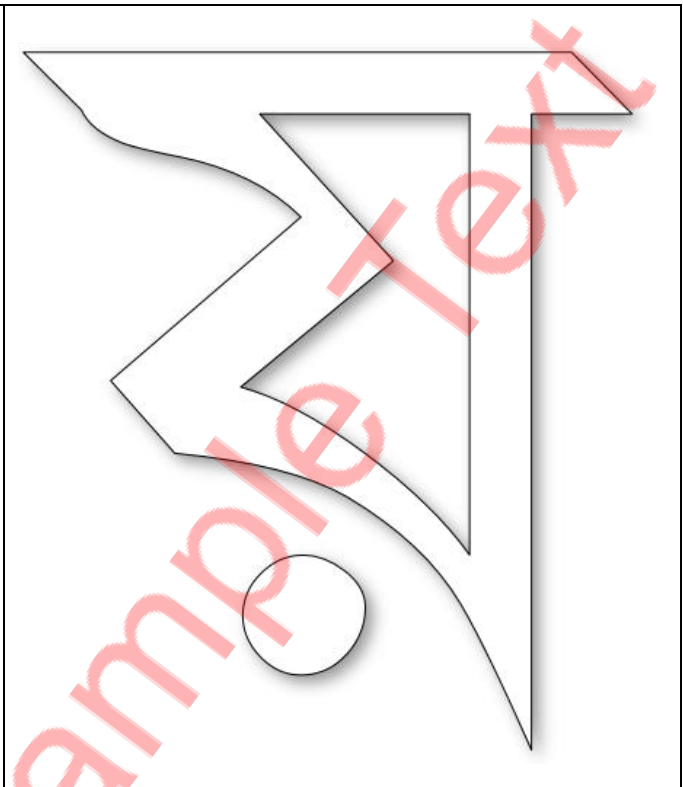
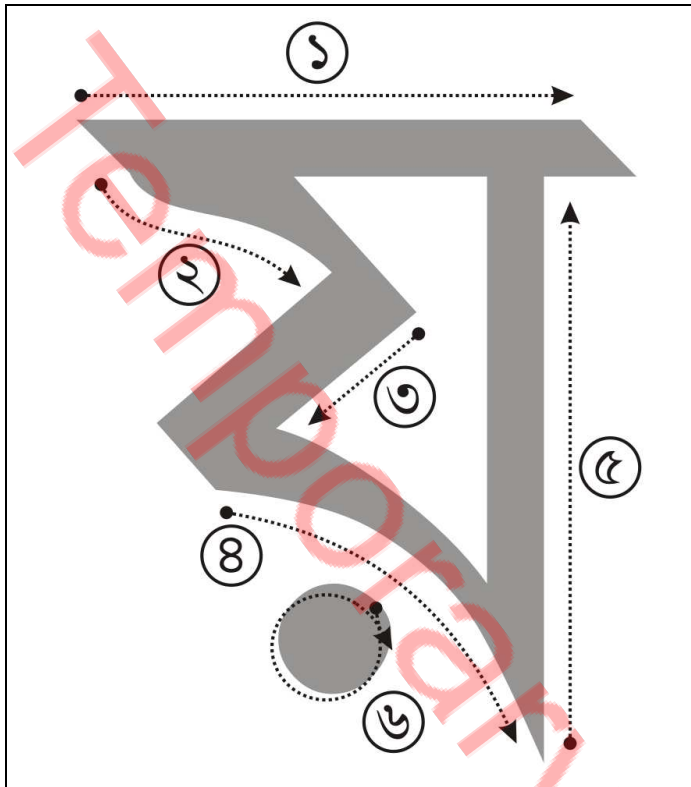

Follow the above steps

Colour it accordingly

ক	খ	গ	ঘ	ঙ	চ	ছ	জ
ঝ	ঞ	ট	ঠ	ড	ঢ	ণ	ত
থ	দ	ধ	ন	প	ফ	ব	ভ
ম	য	র	ল	শ	ষ	স	হ
ড়	ঢ়	য়	৐	৑	৒	৓	৔

Student Name: _____

Verified By: _____

Class: _____

Date: _____

Trace It



Student Name: _____

Verified By: _____

Class: _____

Date: _____

Trace it



Student Name: _____

Verified By: _____

Class: _____

Date: _____

Write it

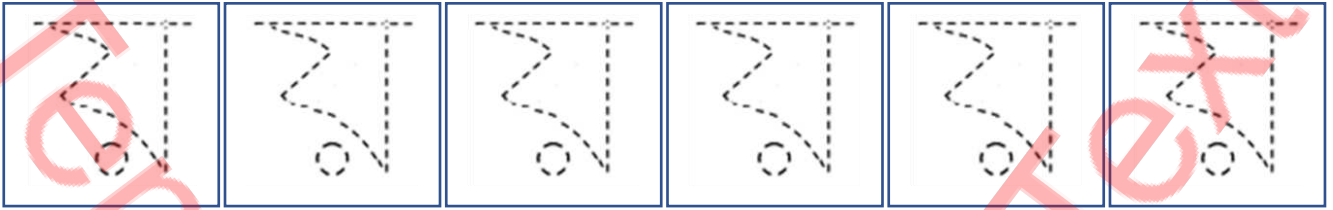

Student Name: _____

Verified By: _____

Class: _____

Date: _____

Copy Colour



Colour it

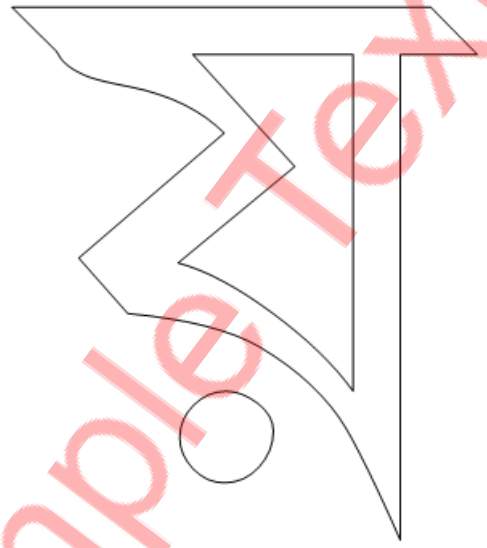

Write it

Find it

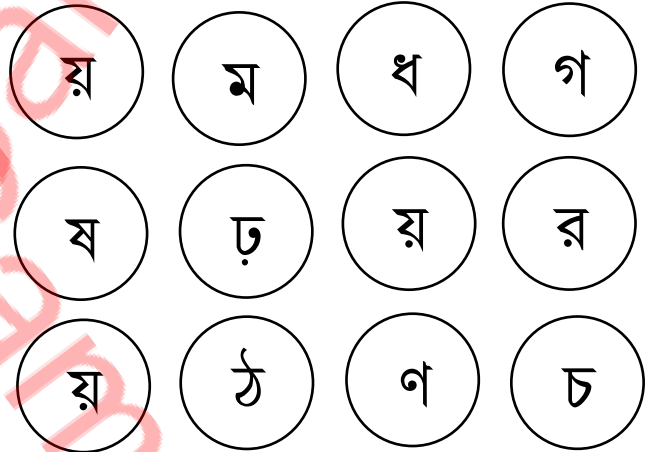
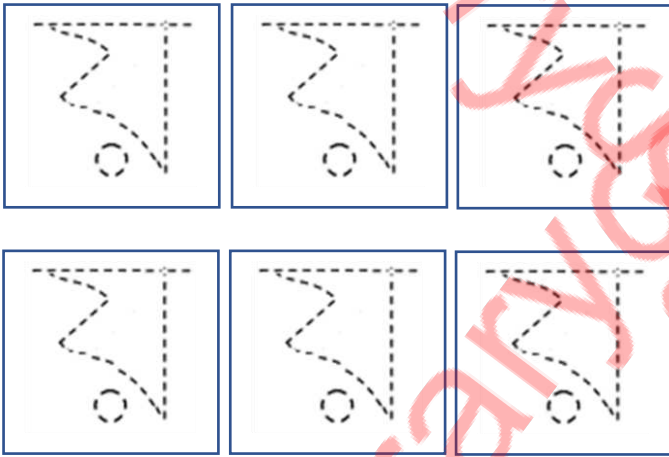

Connect the circle

Do it

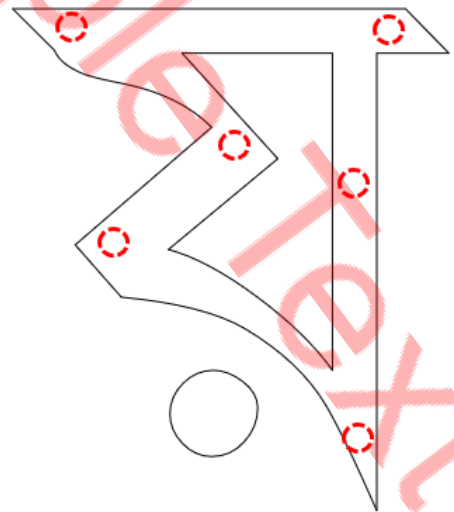
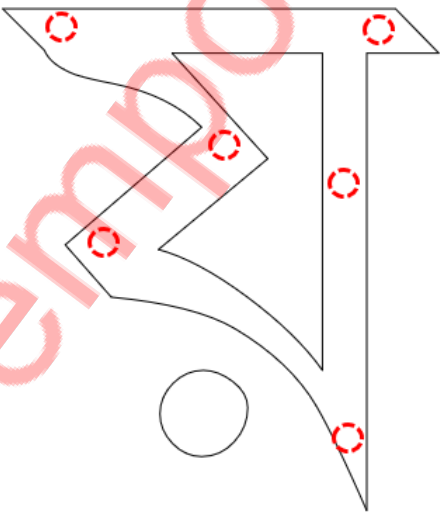

Student Name: _____

Verified By: _____

Class: _____

Date: _____

Pick the Path Find the Correct Alphabet

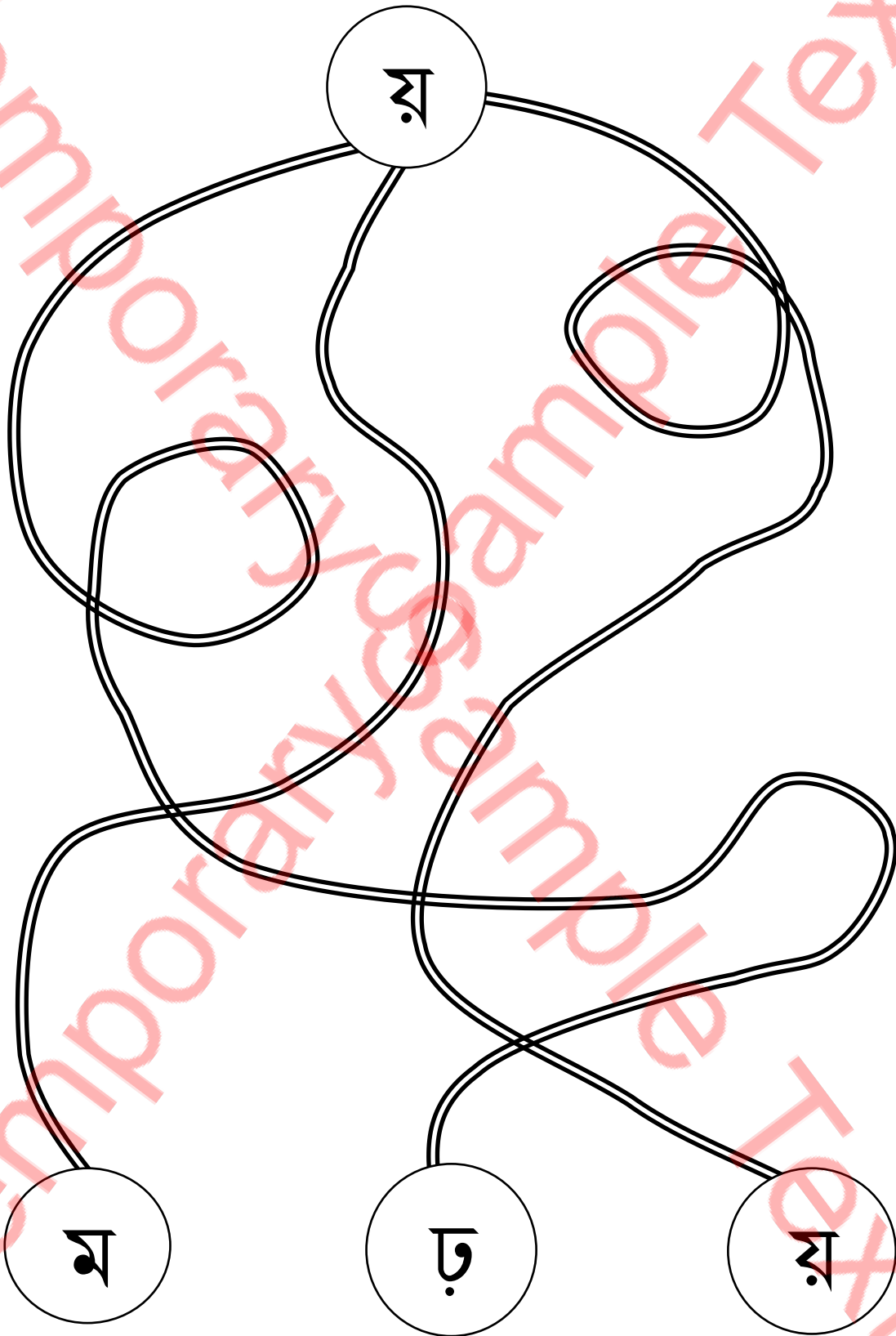

Student Name: _____

Verified By: _____

Class: _____

Date: _____

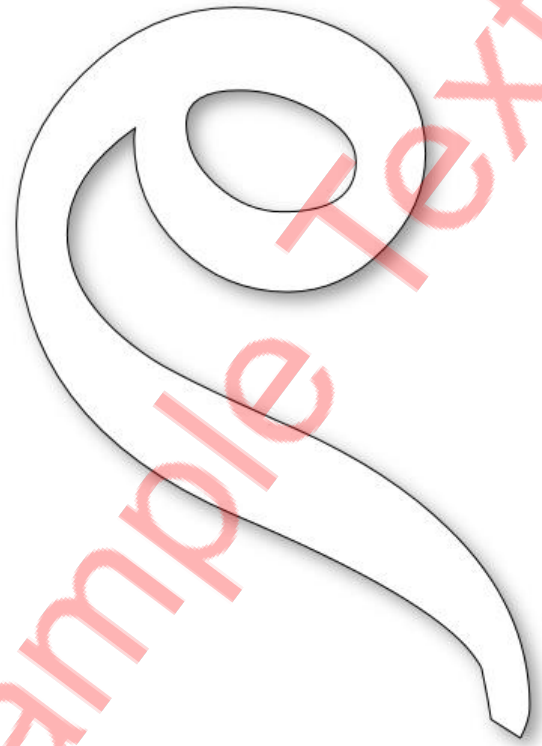
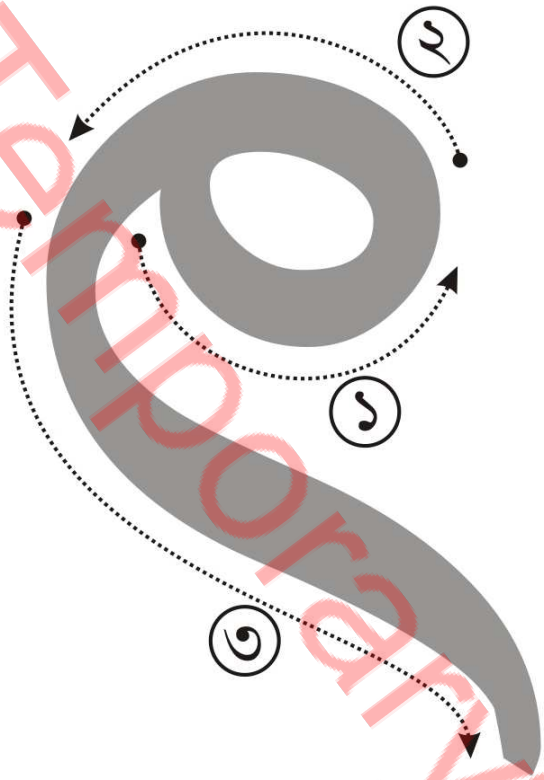

Follow the above steps

Colour it accordingly

ক	খ	গ	ঘ	ঙ	চ	ছ	জ
ঝ	ঞ	ট	ঠ	ড	ঢ	ণ	ত
থ	দ	ধ	ন	প	ফ	ব	ভ
ম	য	র	ল	শ	ষ	স	হ
ড়	ঢ়	য়	৩	৩	৩	৩	

Student Name: _____

Verified By: _____

Class: _____

Date: _____

Trace It

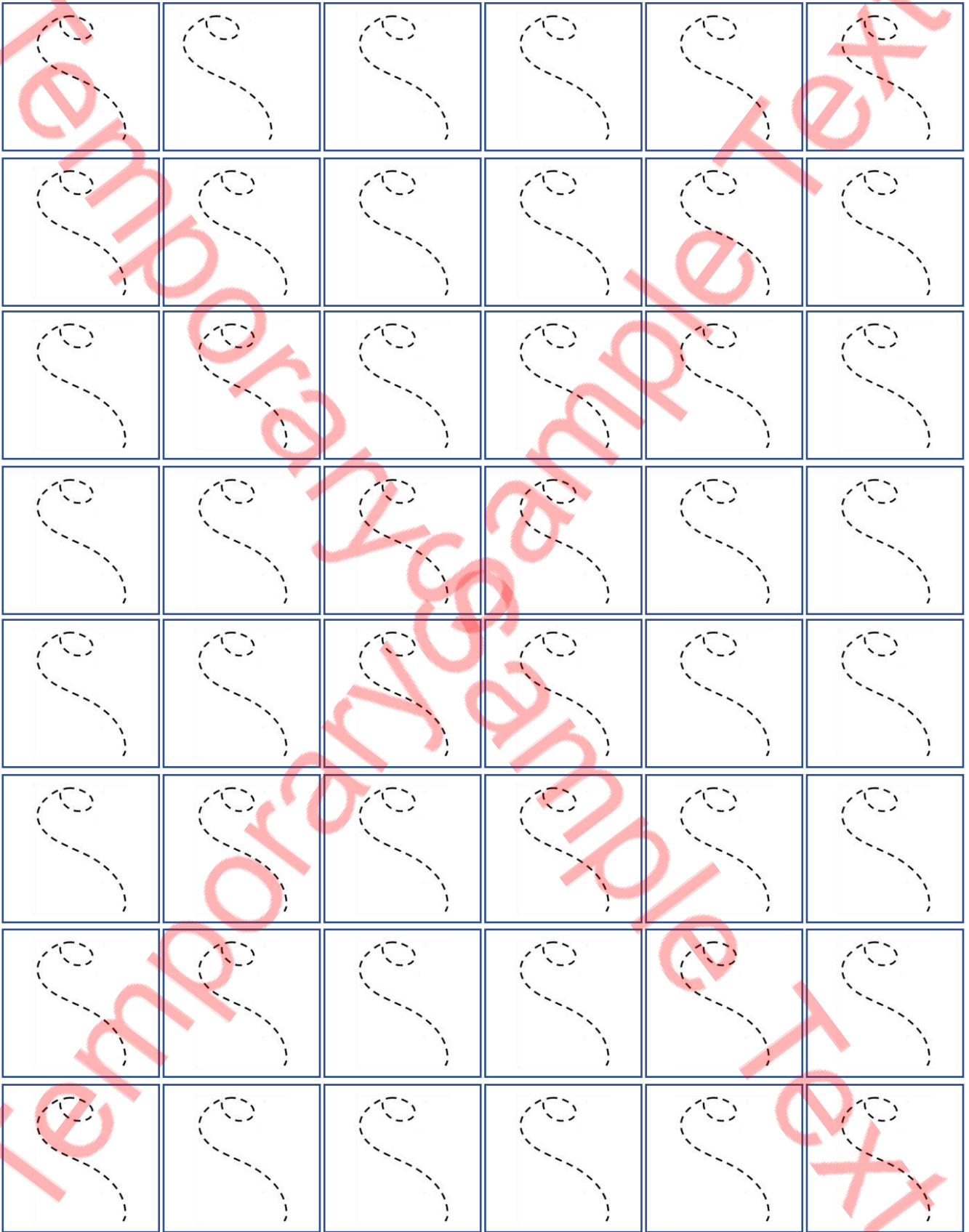

Student Name: _____

Verified By: _____

Class: _____

Date: _____

Trace it

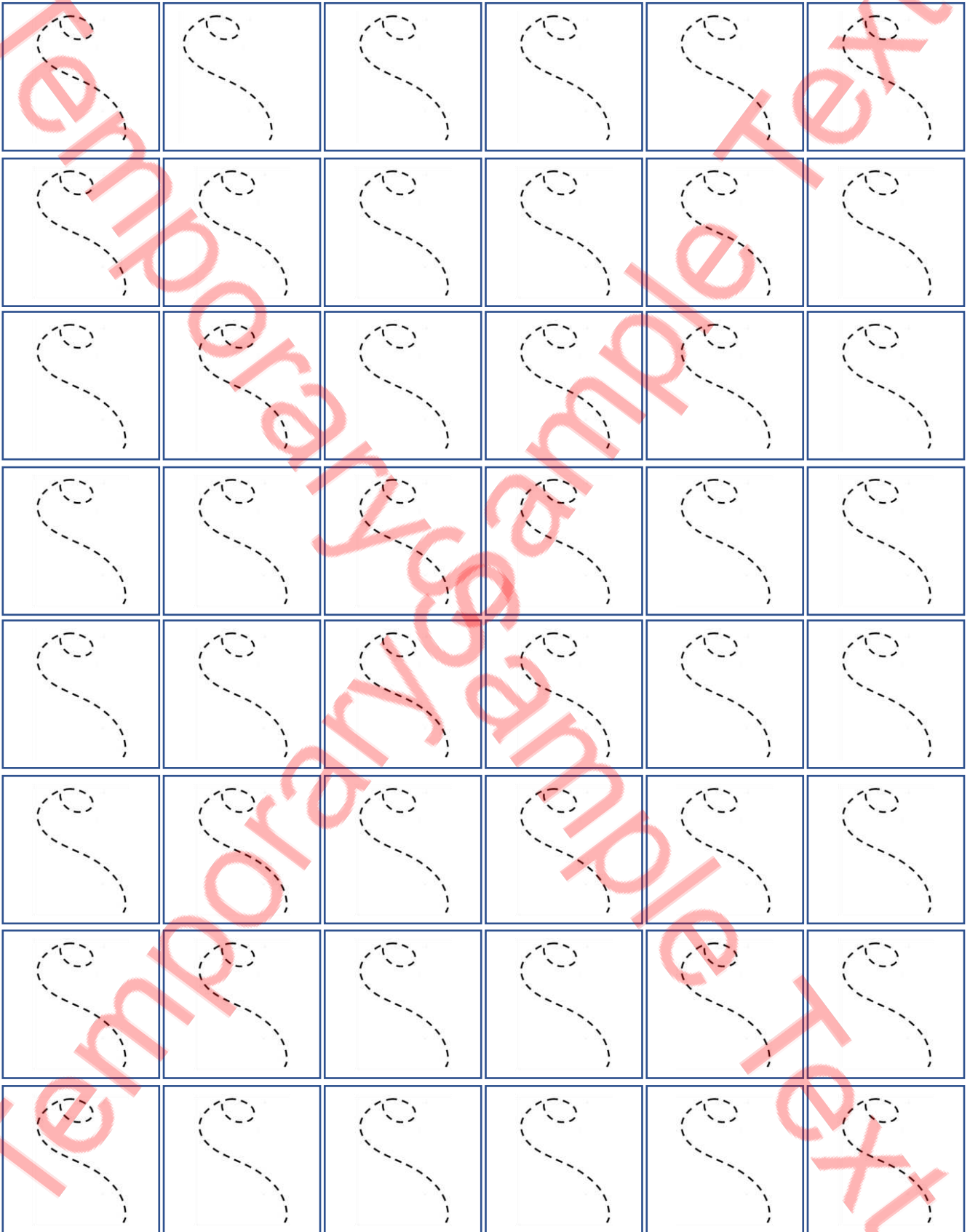

Student Name: _____

Verified By: _____

Class: _____

Date: _____

Write it

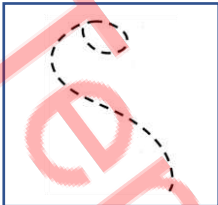
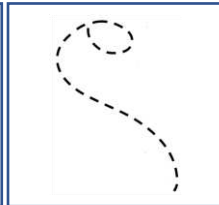
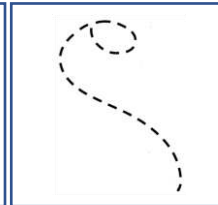
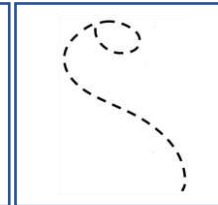
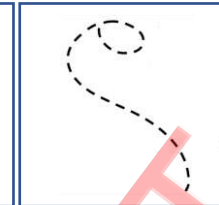
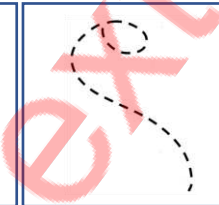
Student Name: _____

Verified By: _____

Class: _____

Date: _____

Copy Colour



Colour it



Write it

Find it

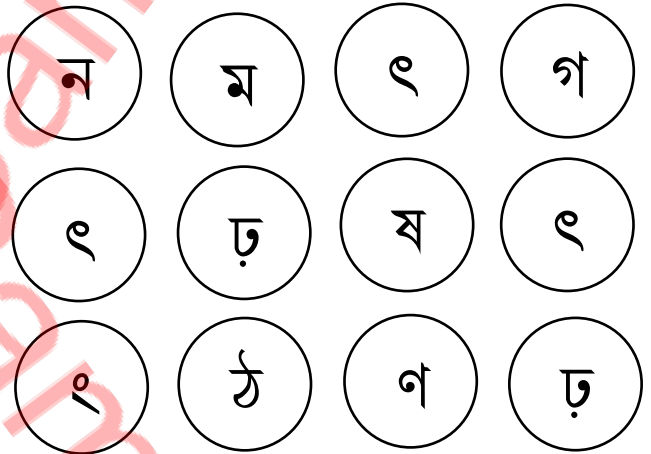
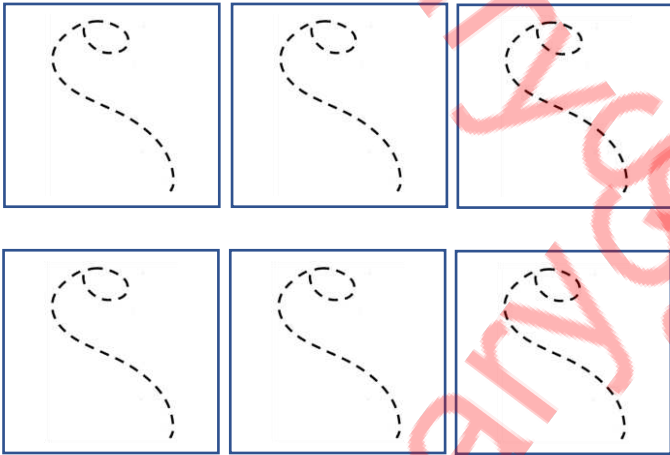

Connect the circle

Do it

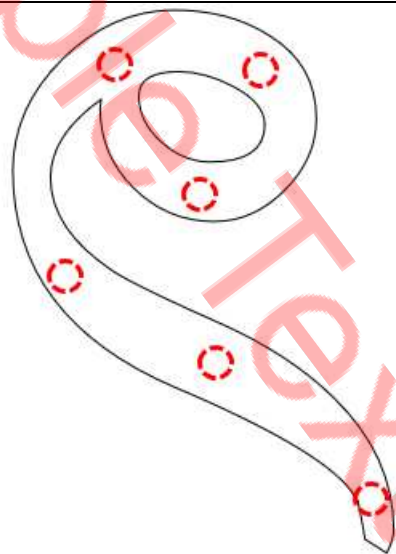
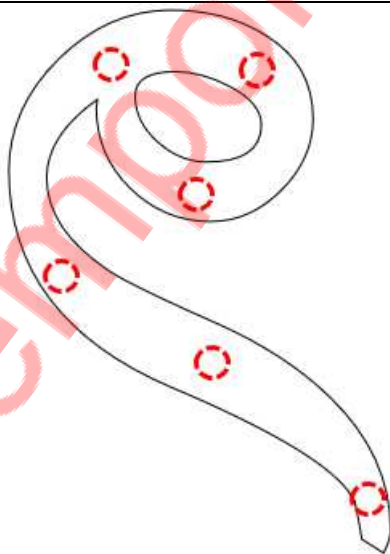

Student Name: _____

Verified By: _____

Class: _____

Date: _____

Pick the Path Find the Correct Alphabet

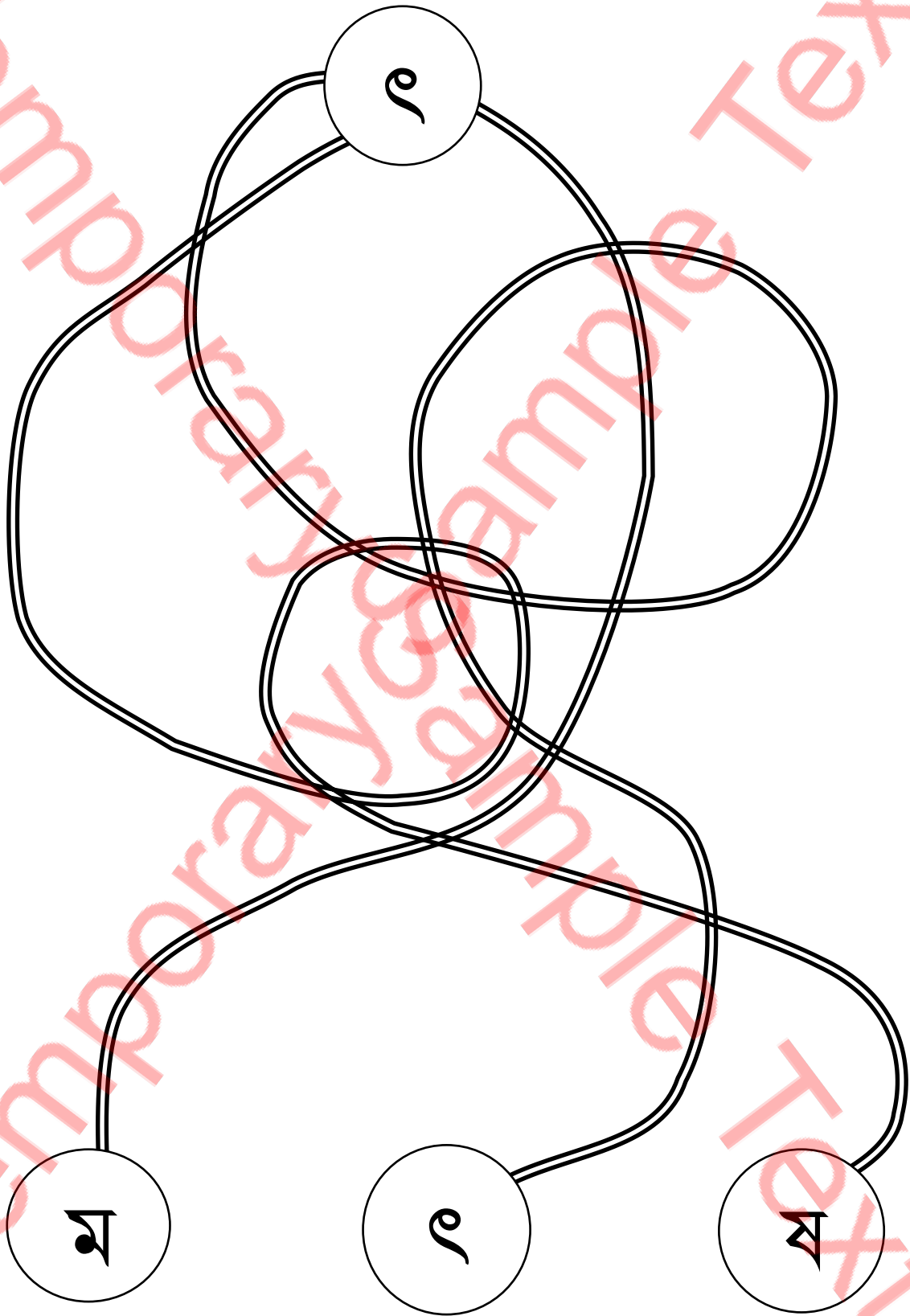

Student Name: _____

Verified By: _____

Class: _____

Date: _____

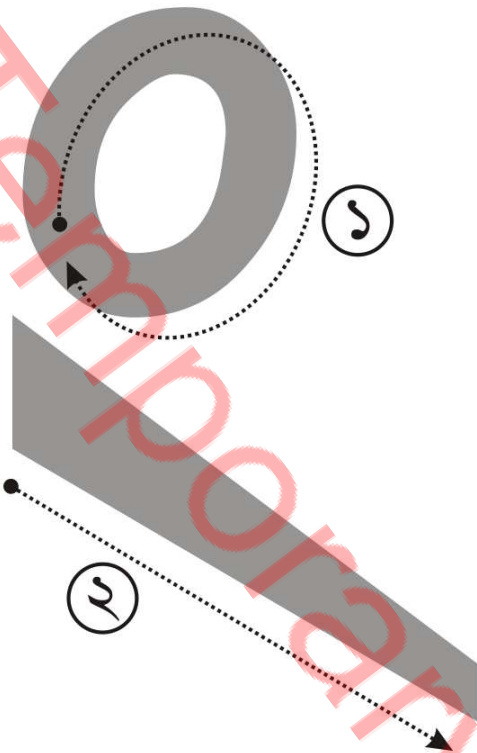

Follow the above steps

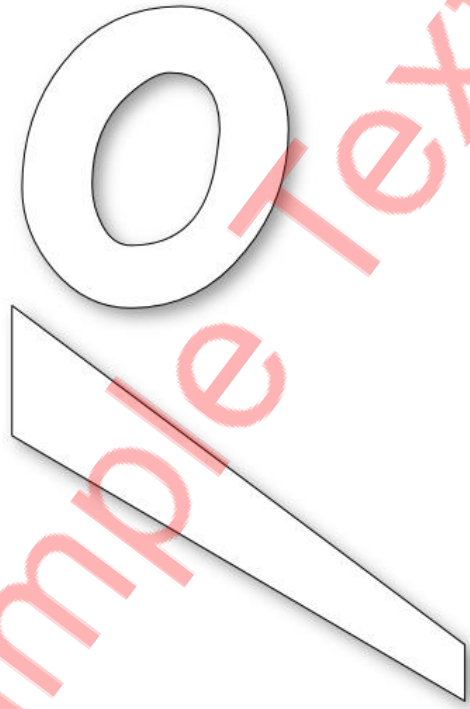

Colour it accordingly

ক	খ	গ	ঘ	ঙ	চ	ছ	জ
ঝ	ঞ	ট	ঠ	ড	ঢ	ণ	ত
থ	দ	ধ	ন	প	ফ	ব	ভ
ম	য	র	ল	শ	ষ	স	হ
০	১	২	৩	৪	৫	৬	৭

Student Name: _____

Verified By: _____

Class: _____

Date: _____

Trace It

Student Name: _____

Verified By: _____

Class: _____

Date: _____

Trace it

Student Name: _____

Verified By: _____

Class: _____

Date: _____

Write it

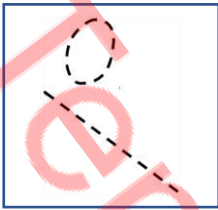
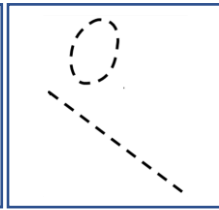
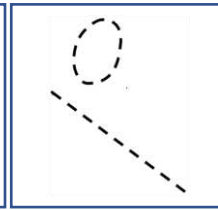
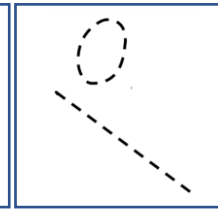
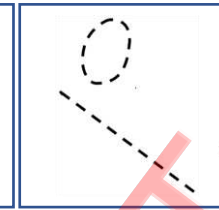
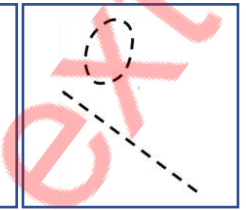
Student Name: _____

Verified By: _____

Class: _____

Date: _____

Copy Colour

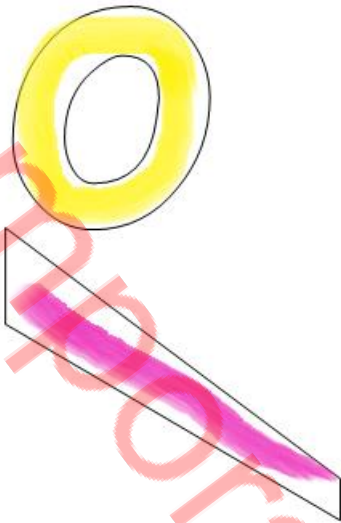

Colour it

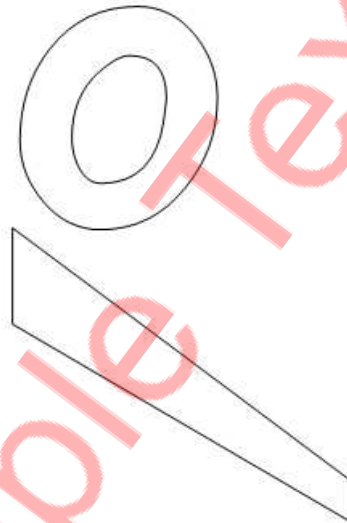

Write it

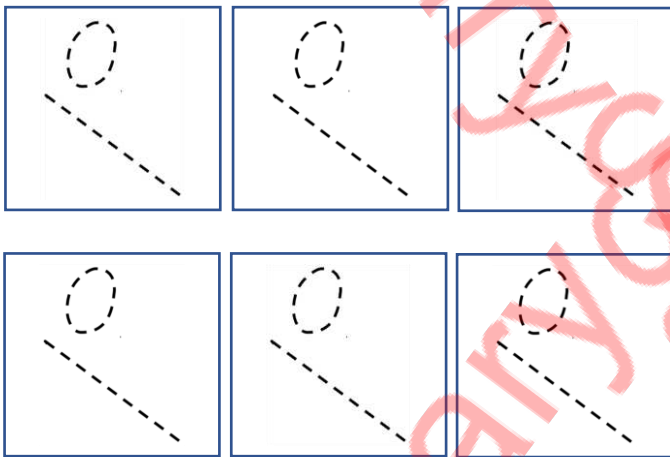

Find it

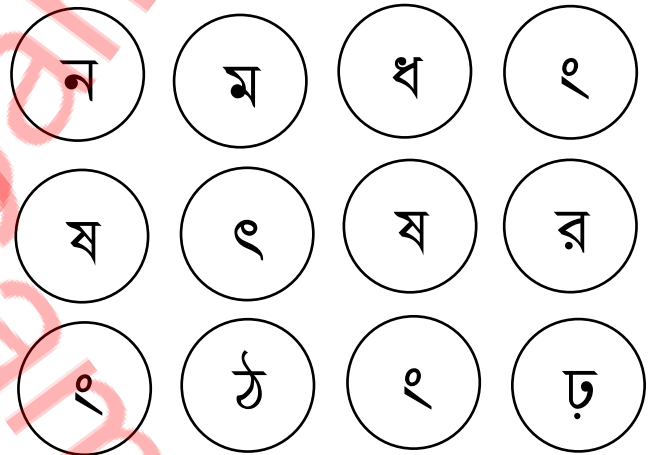

Connect the circle

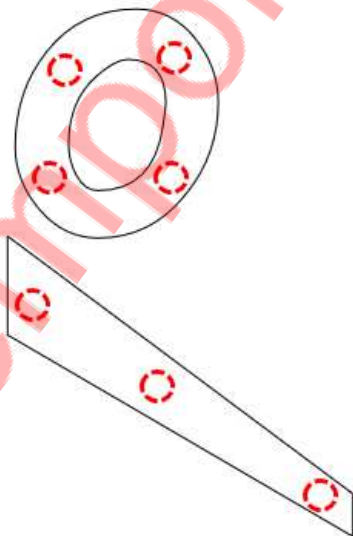

Do it

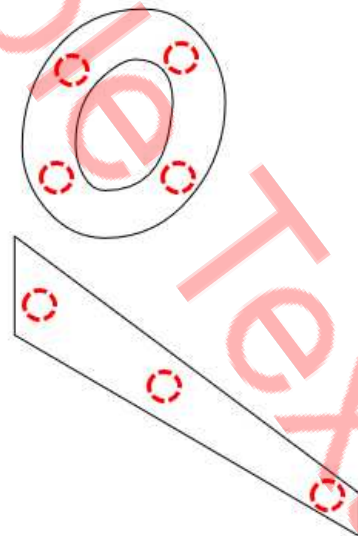

Student Name: _____

Verified By: _____

Class: _____

Date: _____

Pick the Path Find the Correct Alphabet

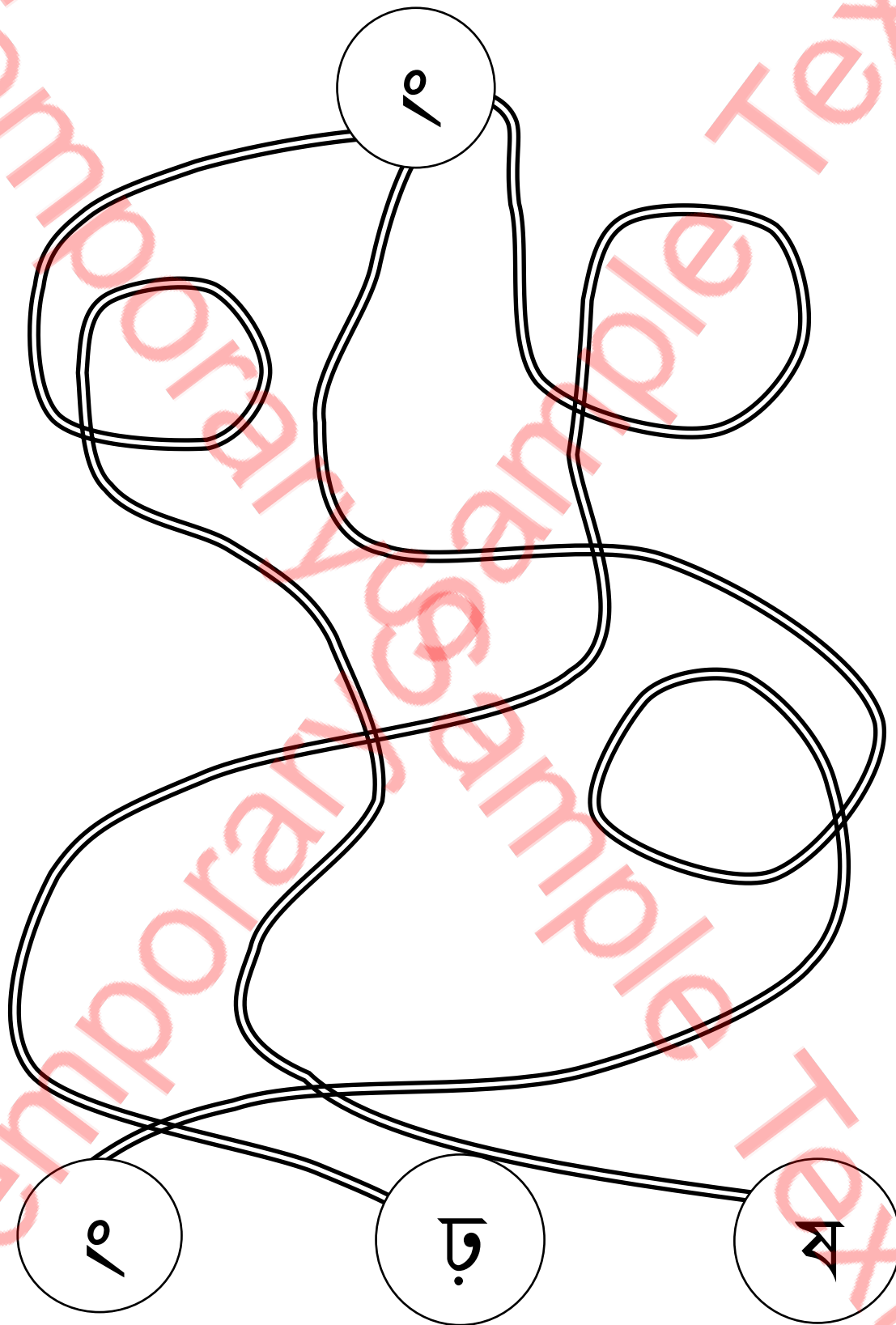

Student Name: _____

Verified By: _____

Class: _____

Date: _____

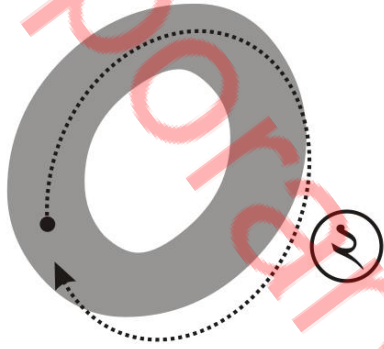
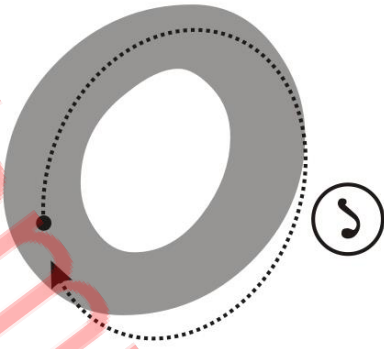

Follow the above steps

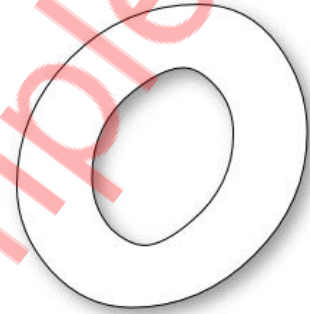

Colour it accordingly

ক	খ	গ	ঘ	ঙ	চ	ছ	জ
ঝ	ঞ	ট	ঠ	ড	ঢ	ণ	ত
থ	দ	ধ	ন	প	ফ	ব	ভ
ম	য	র	শ	ষ	স	হ	
ড়	ঢ়	য়	ৱ	৲	৳	৴	

Student Name: _____

Verified By: _____

Class: _____

Date: _____

Trace It

o	o	o	o	o	o
o	o	o	o	o	o
o	o	o	o	o	o
o	o	o	o	o	o
o	o	o	o	o	o
o	o	o	o	o	o
o	o	o	o	o	o
o	o	o	o	o	o
o	o	o	o	o	o
o	o	o	o	o	o

Student Name: _____

Verified By: _____

Class: _____

Date: _____

Trace it



Student Name: _____

Verified By: _____

Class: _____

Date: _____

Write it

o	o	o	o	o	o
o	o	o	o	o	o

Student Name: _____

Verified By: _____

Class: _____

Date: _____

Copy Colour



Colour it

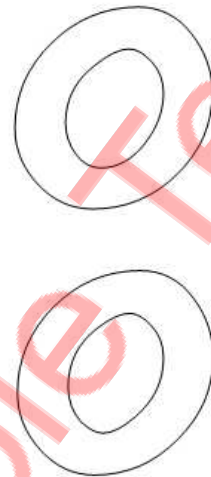

Write it

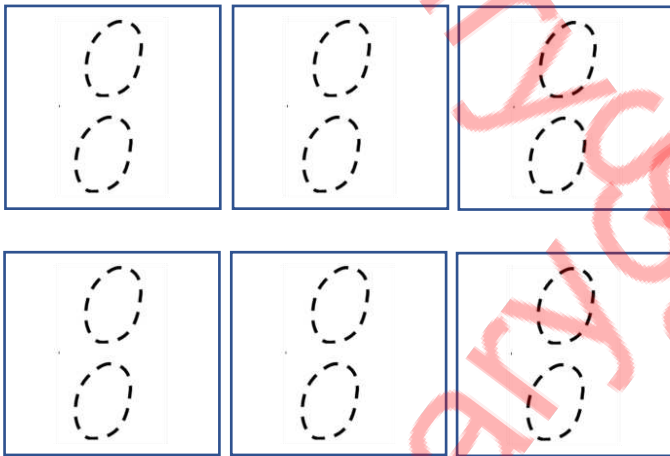

Find it

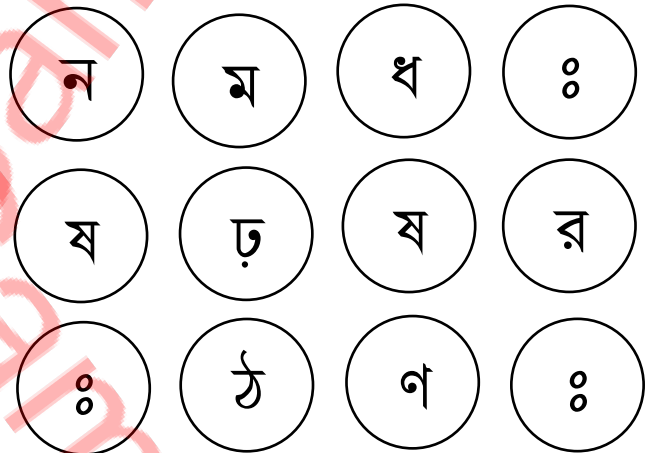

Connect the circle

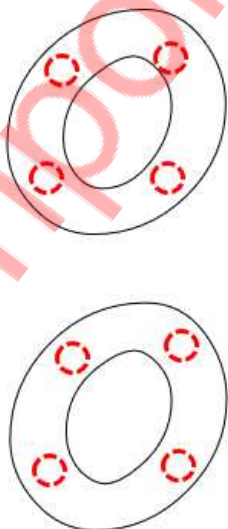

Do it

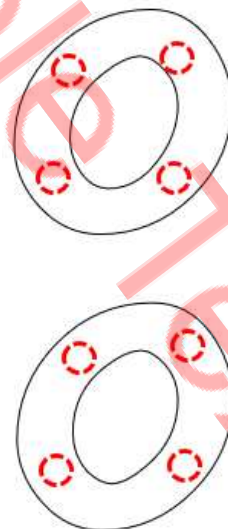

Student Name: _____

Class: _____

Verified By: _____

Date: _____

Pick the Path Find the Correct Alphabet

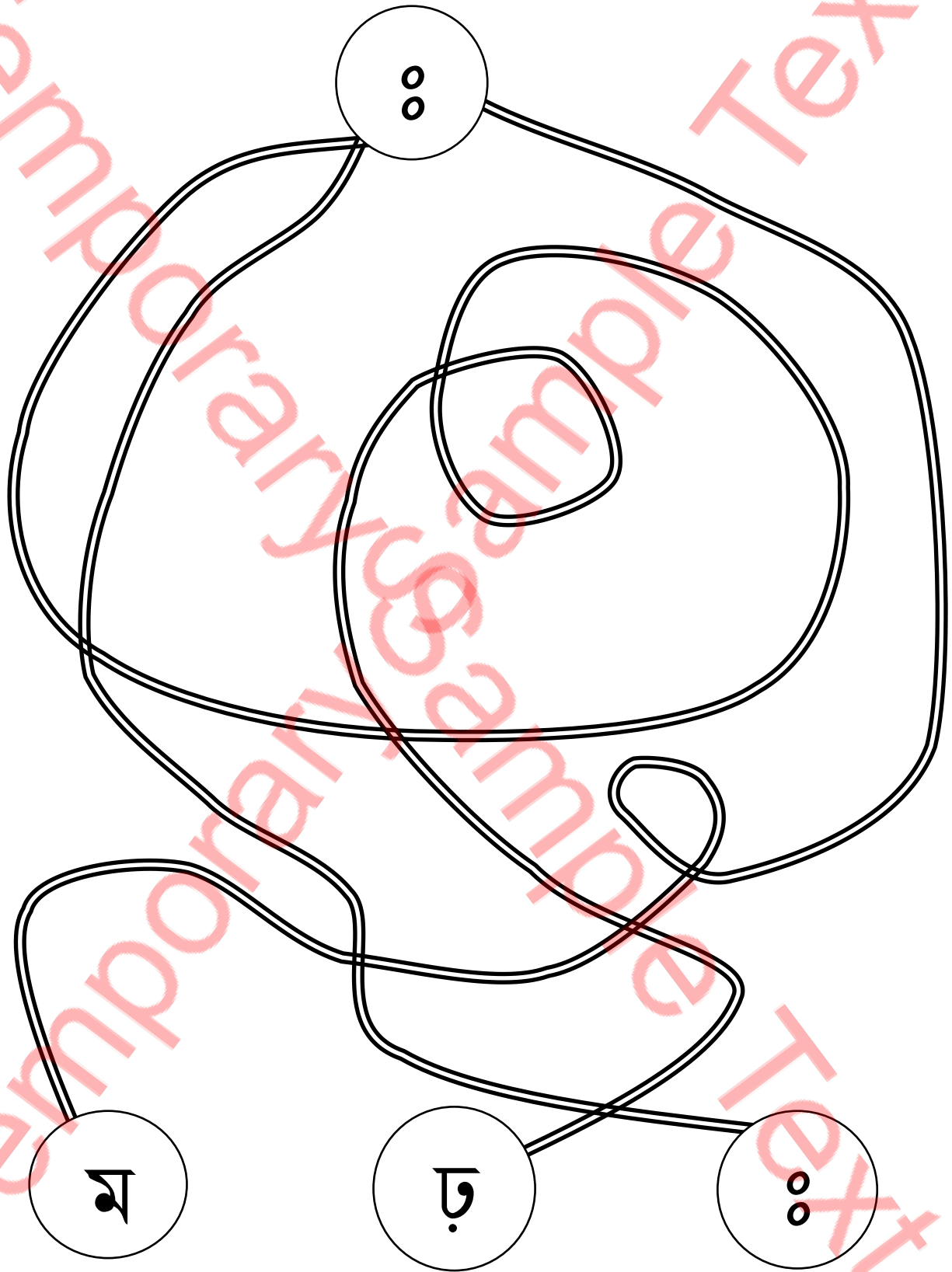

Student Name: _____

Verified By: _____

Class: _____

Date: _____

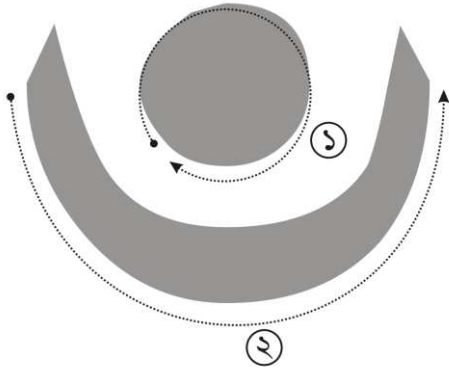

Follow the above steps

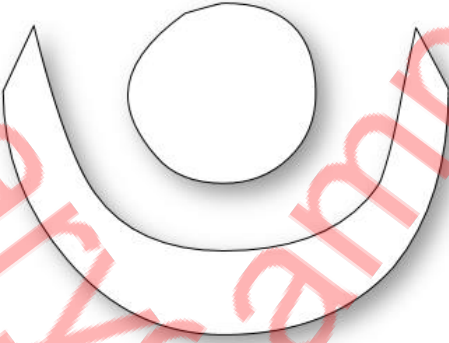

Colour it accordingly

ক	খ	গ	ঘ	ঙ	চ	ছ	জ
ঝ	ঞ	ট	ঠ	ড	ঢ	ণ	ত
থ	দ	ধ	ন	প	ফ	ব	ভ
ম	য	র	ল	শ	ষ	স	হ
ড়	ঢ়	য়	ৎ	ৎ	ঃ	ঃ	

Student Name: _____

Verified By: _____

Class: _____

Date: _____

Trace It



Student Name: _____

Verified By: _____

Class: _____

Date: _____

Trace it



Student Name: _____

Verified By: _____

Class: _____

Date: _____

Write it

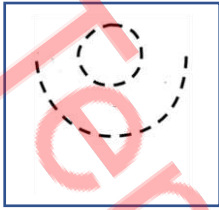
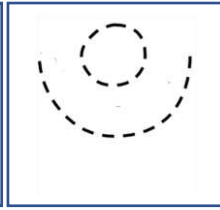
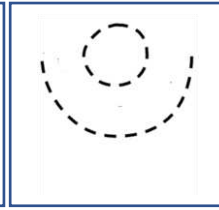
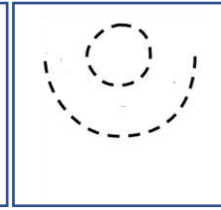
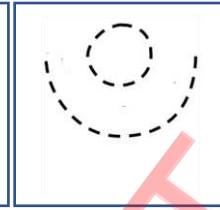
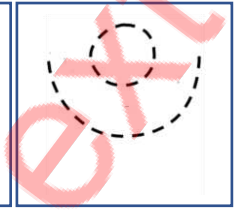
Student Name: _____

Verified By: _____

Class: _____

Date: _____

Copy Colour

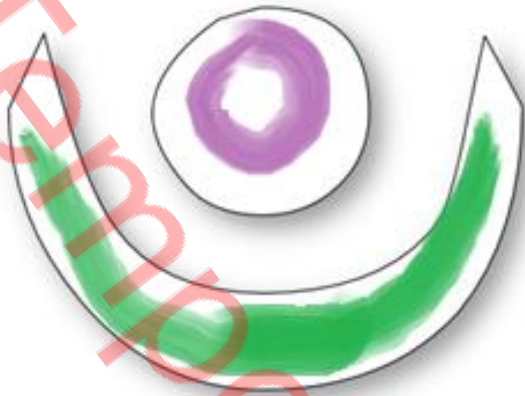

Colour it



Write it

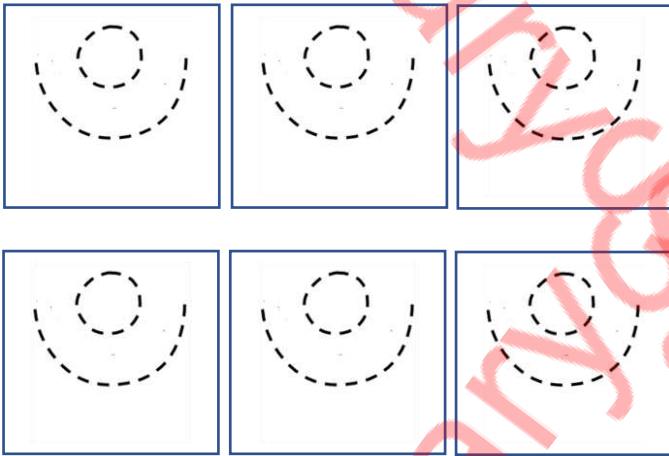

Find it

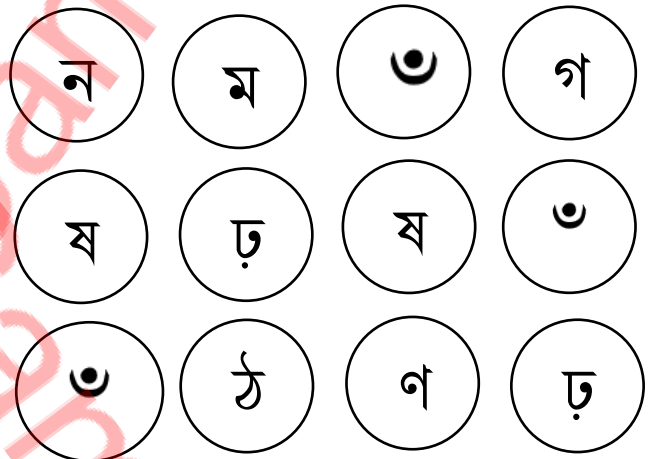

Connect the circle

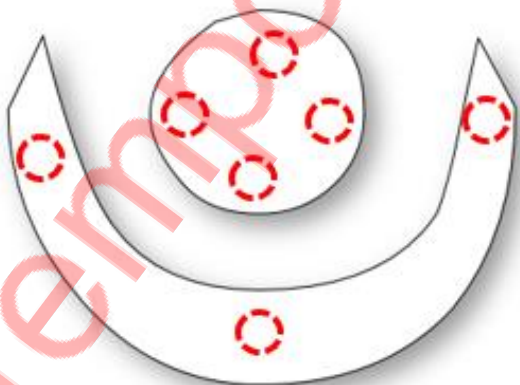

Do it



Student Name: _____

Verified By: _____

Class: _____

Date: _____

Pick the Path Find the Correct Alphabet

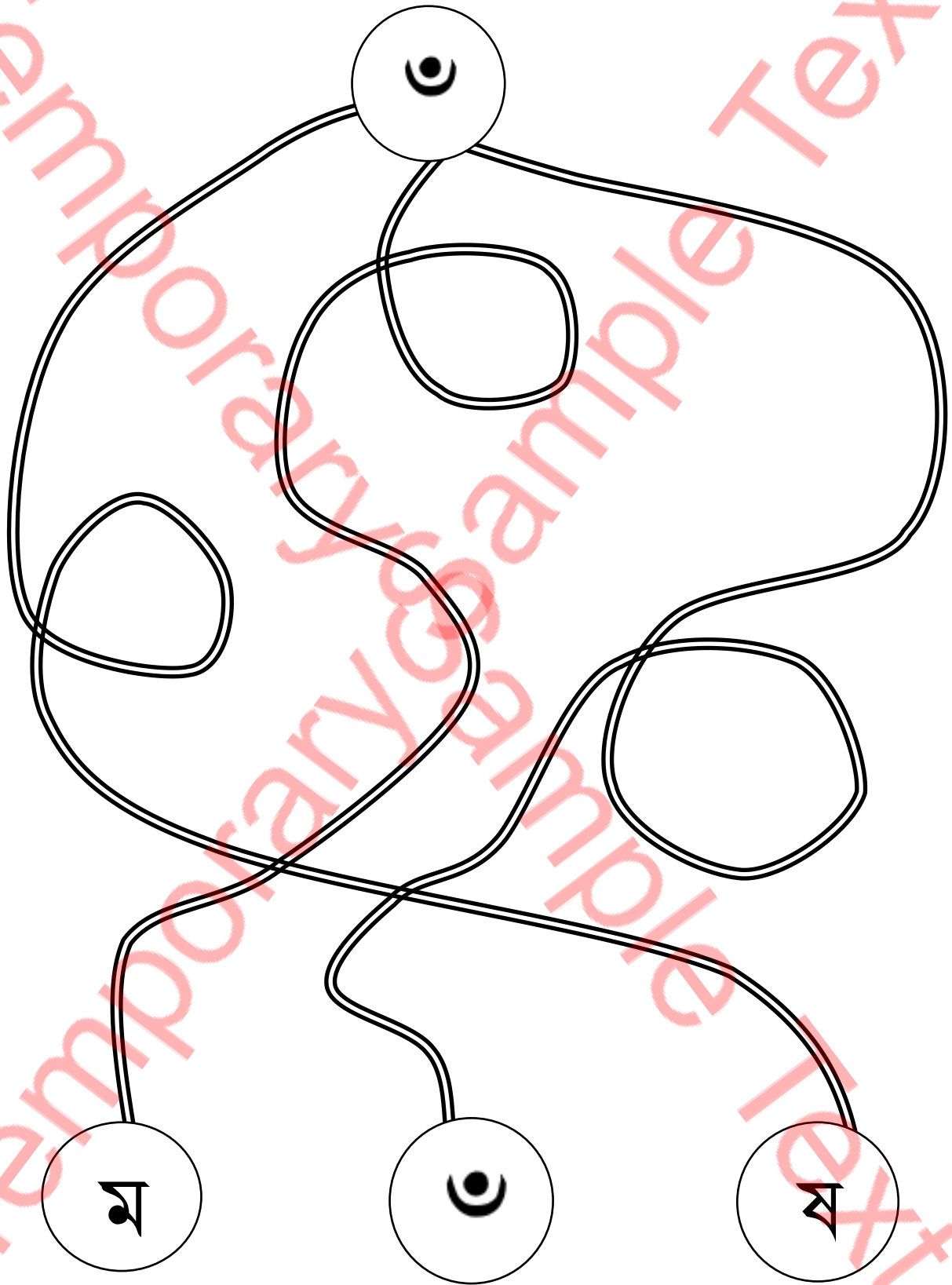

Student Name: _____

Verified By: _____

Class: _____

Date: _____