

Follow the above steps

Colour this accordingly

ক	খ	গ	ঘ	ঙ	চ	ছ	জ
ঝ	ঞ	ট	ঠ	ড	ঢ	ণ	ত
থ	দ	ধ	ন	প	ফ	ব	ভ
ম	য	ষ	প্র	র	শ	ষ	স
হ	ক্ষ	ড	ঢ	য়	ং	ঃ	ঁ

Student Name: \_\_\_\_\_

Verified By: \_\_\_\_\_

Class: \_\_\_\_\_

Date: \_\_\_\_\_

# Trace It

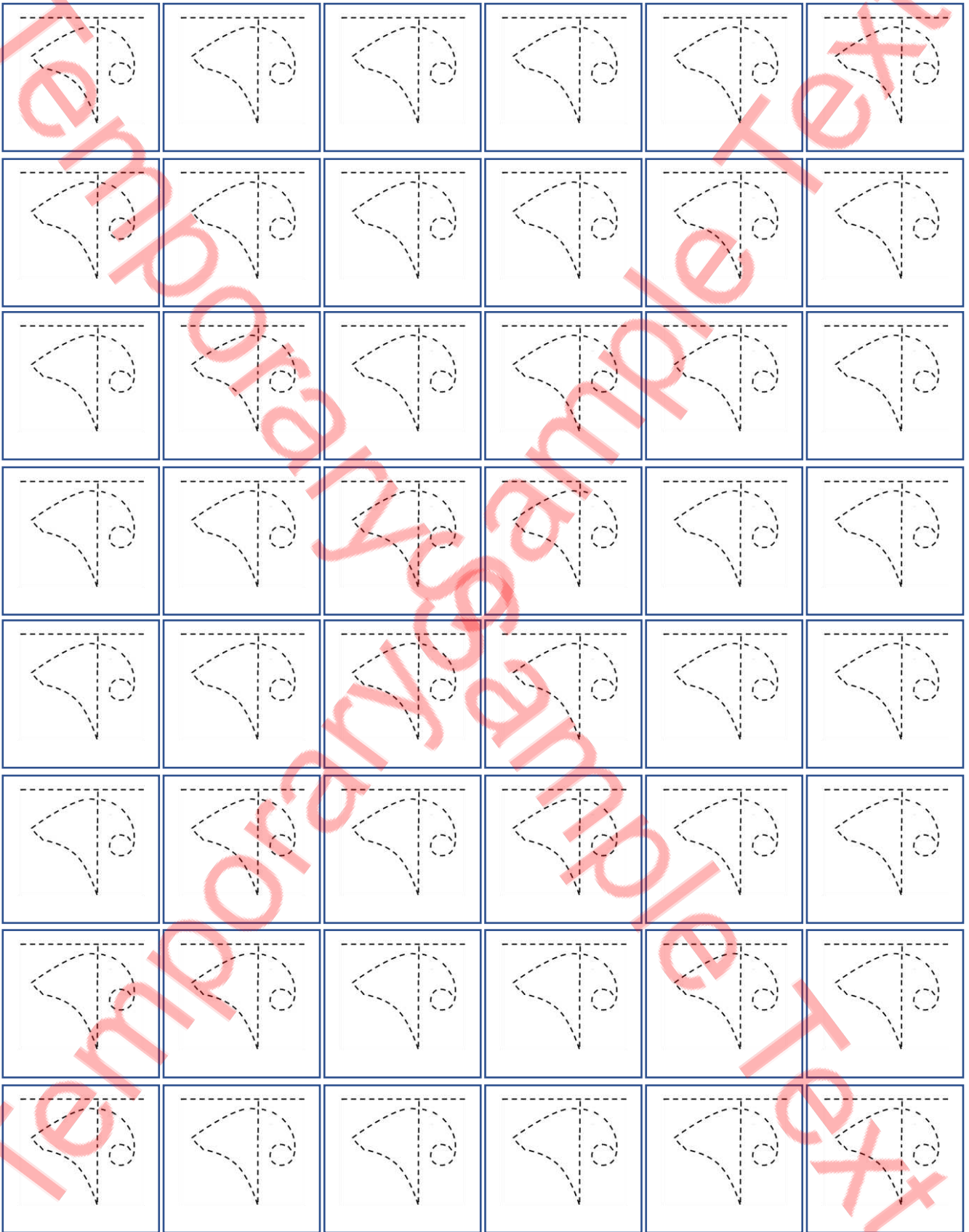

Student Name: \_\_\_\_\_

Verified By: \_\_\_\_\_

Class: \_\_\_\_\_

Date: \_\_\_\_\_

# Trace it

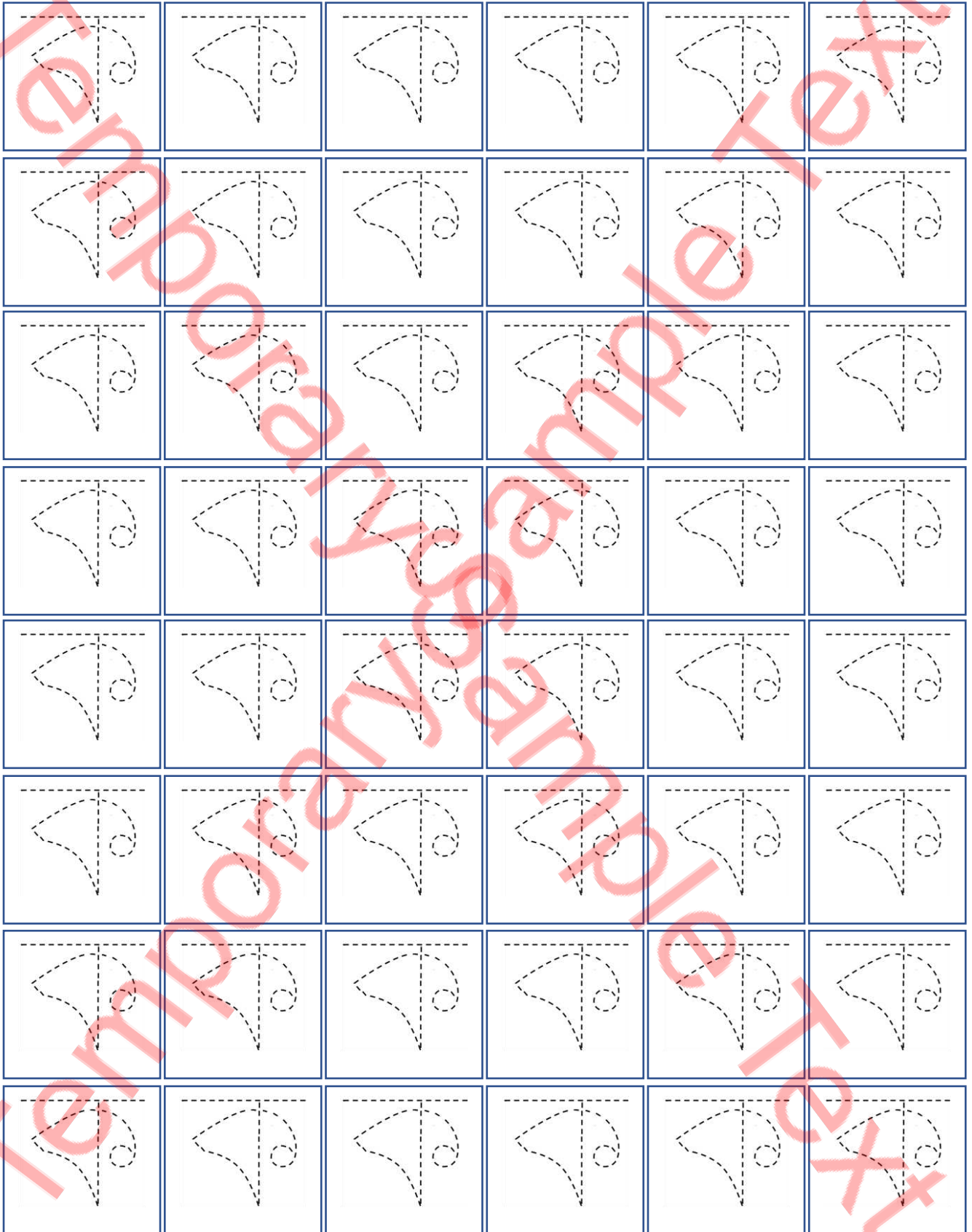

Student Name: \_\_\_\_\_

Verified By: \_\_\_\_\_

Class: \_\_\_\_\_

Date: \_\_\_\_\_

Write it

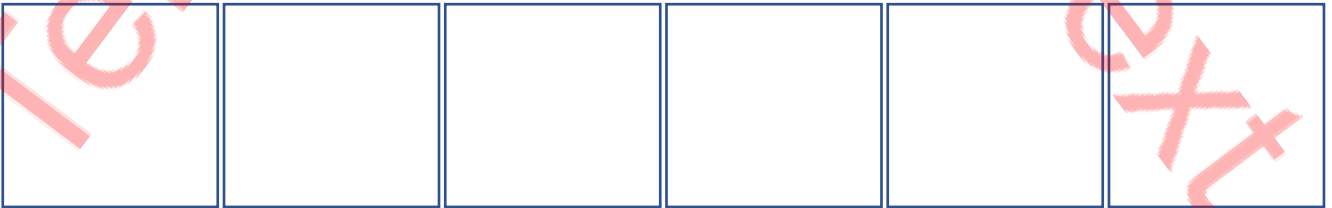
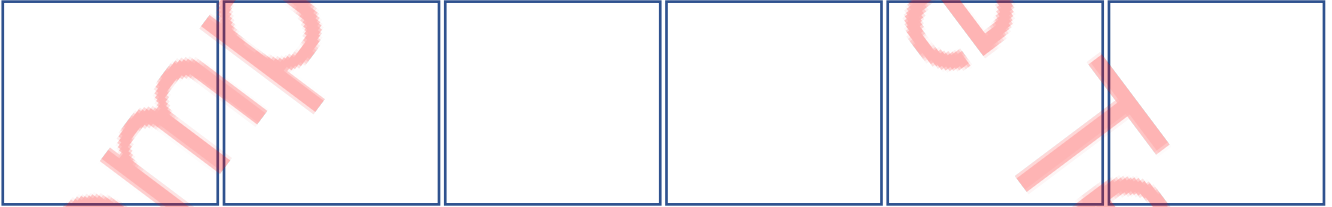
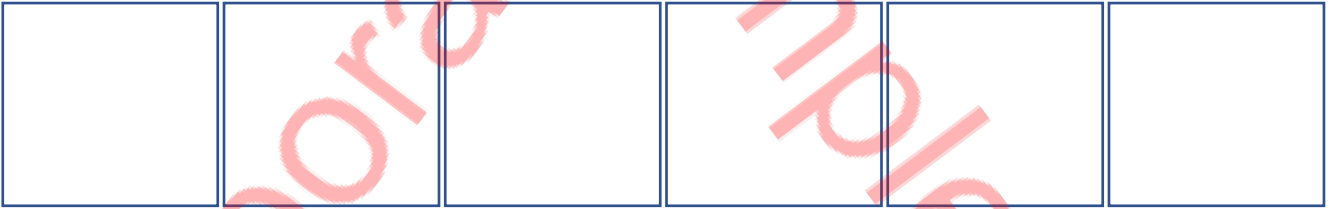
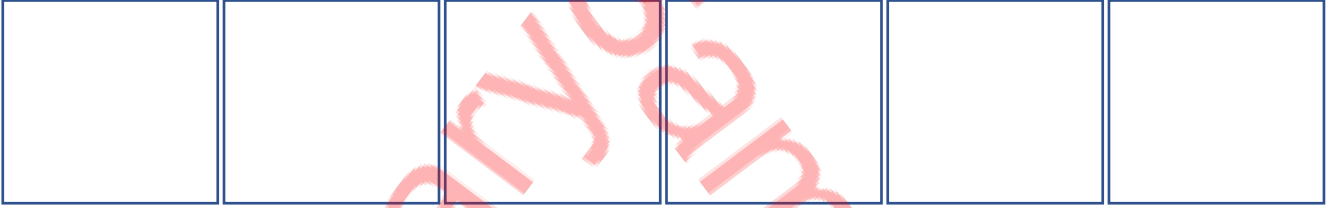
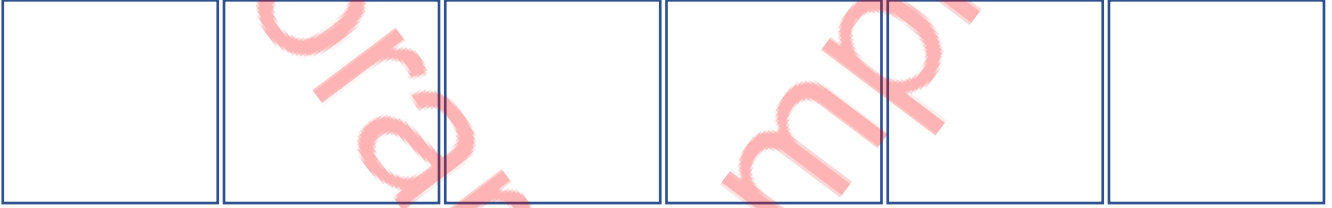
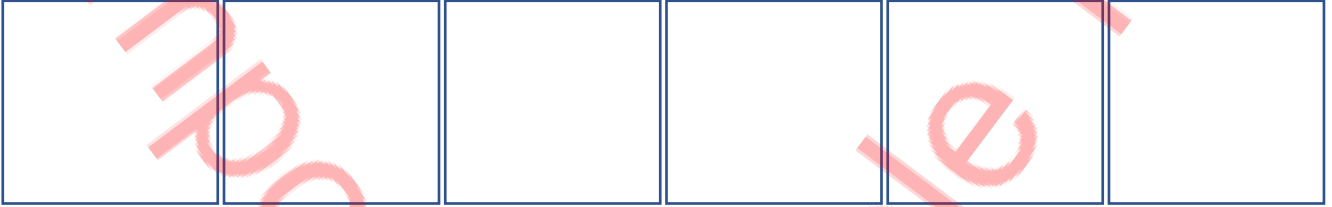
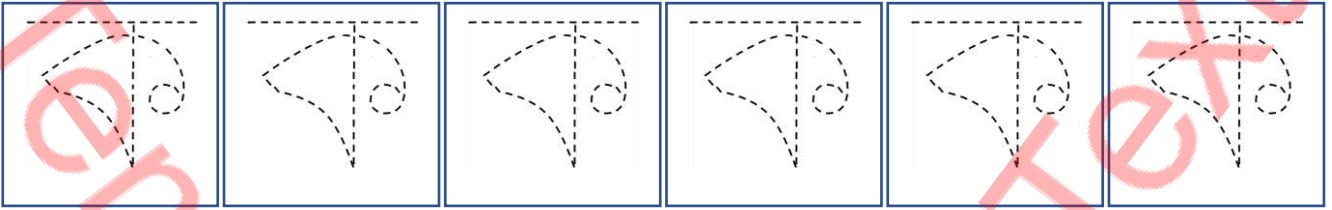

Student Name: \_\_\_\_\_

Verified By: \_\_\_\_\_

Class: \_\_\_\_\_

Date: \_\_\_\_\_



Copy Colour

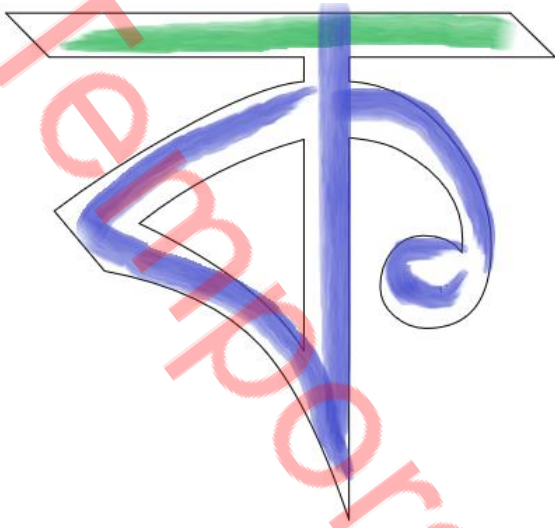

Colour it

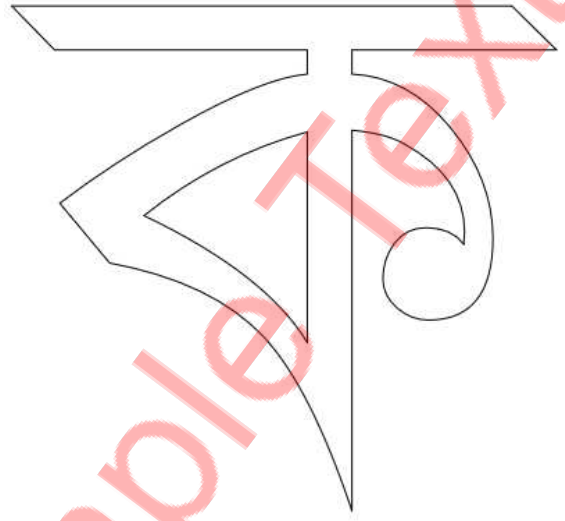

Write it

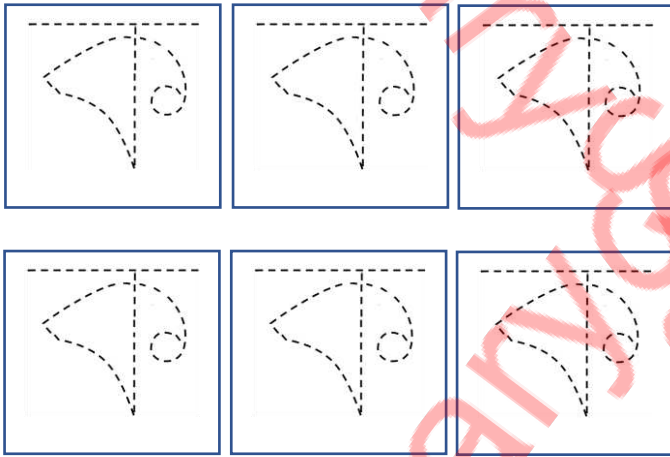

Find it

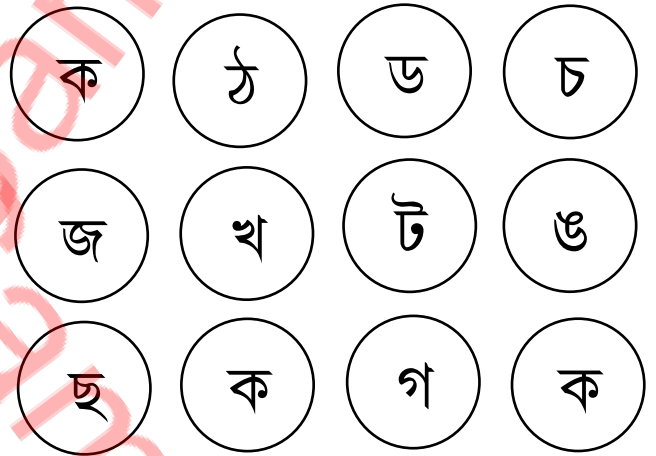

Connect the circle

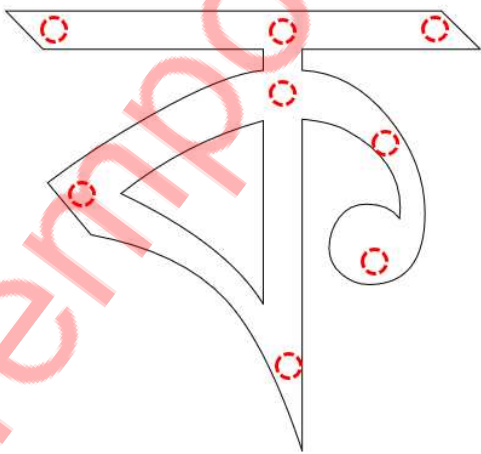

Do it

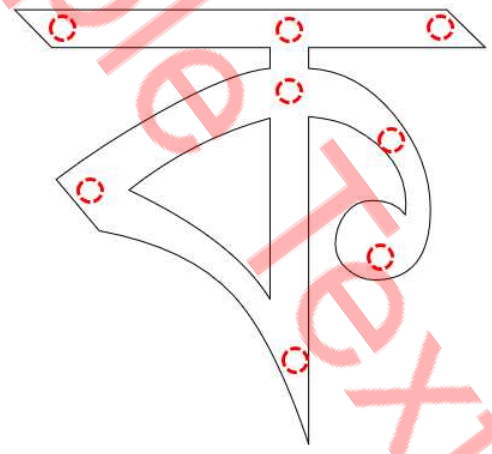

Student Name: \_\_\_\_\_

Verified By: \_\_\_\_\_

Class: \_\_\_\_\_

Date: \_\_\_\_\_

# Pick the Path Find the Correct Alphabet

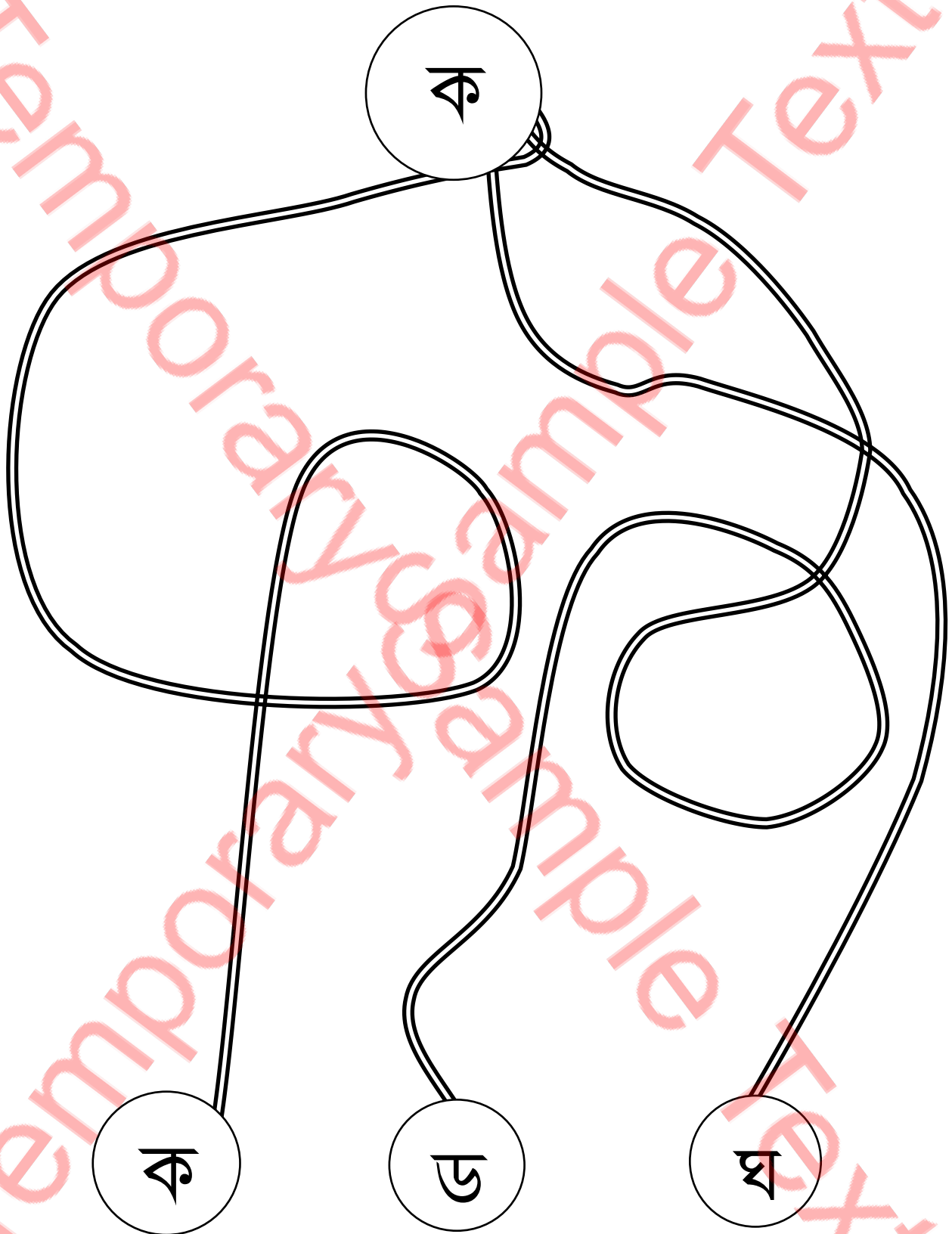

Student Name: \_\_\_\_\_

Verified By: \_\_\_\_\_

Class: \_\_\_\_\_

Date: \_\_\_\_\_

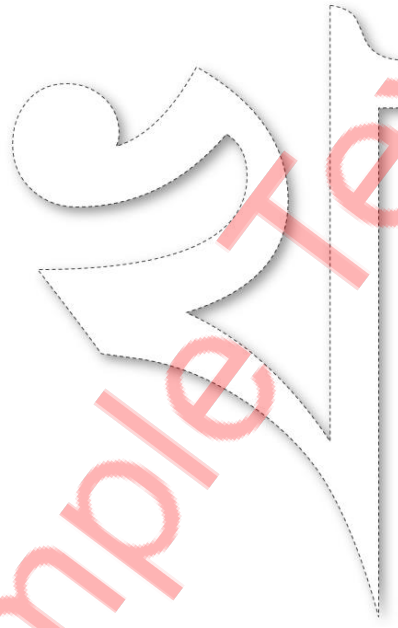
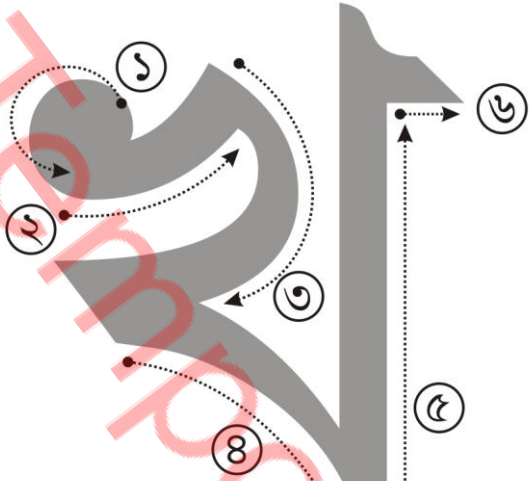

Follow the above steps

Colour this accordingly

ক	খ	গ	ঘ	ঙ	চ	ছ	জ
ঝ	ঞ	ট	ঠ	ড	ঢ	ণ	ত
থ	দ	ধ	ন	প	ফ	ব	ভ
ম	য	র	ল	শ	ষ	স	
হ	ক্ষ	ড়	ঢ়	য়	ং	ঃ	ঁ

Student Name: \_\_\_\_\_

Verified By: \_\_\_\_\_

Class: \_\_\_\_\_

Date: \_\_\_\_\_

## Trace It

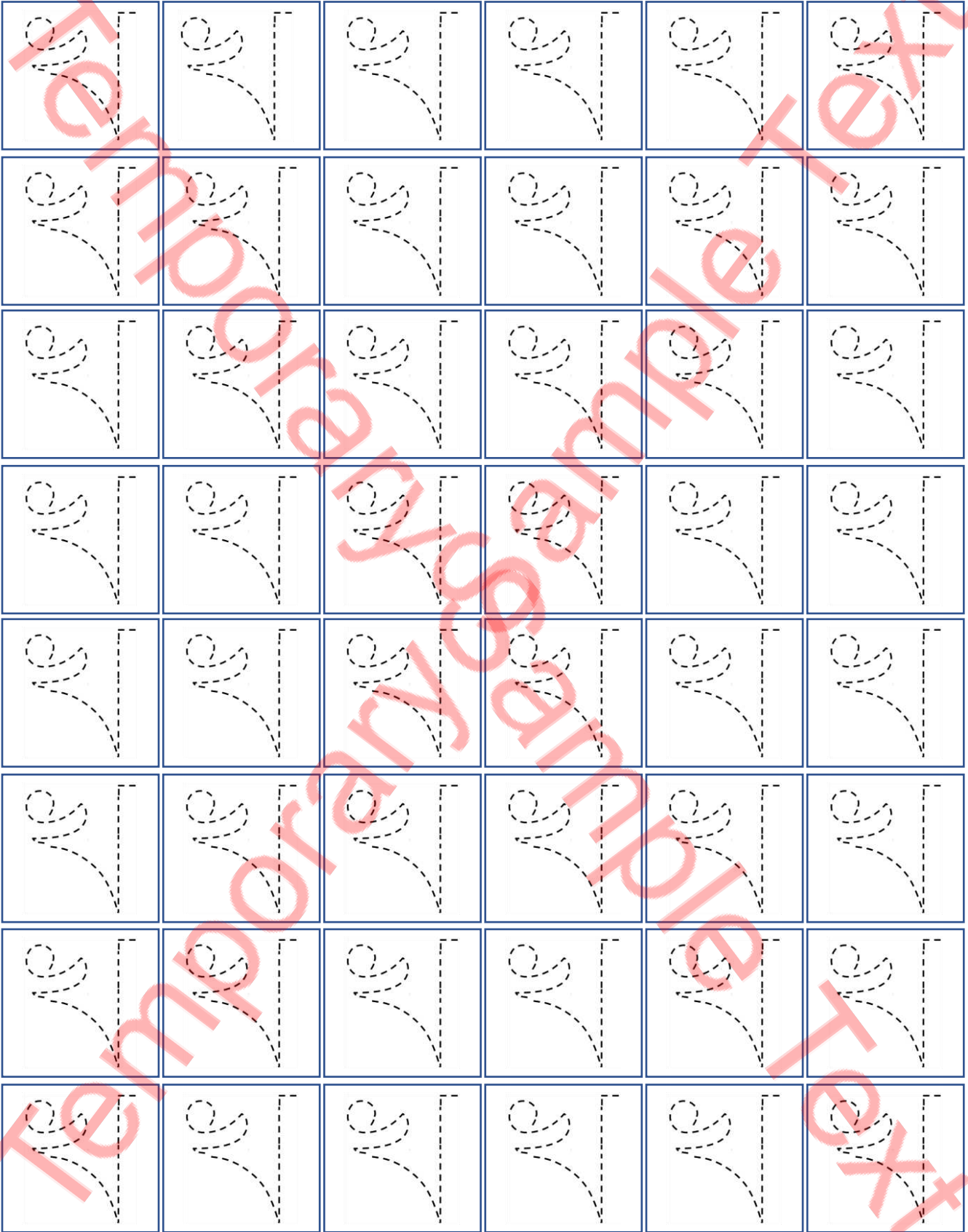

Student Name: \_\_\_\_\_

Verified By: \_\_\_\_\_

Class: \_\_\_\_\_

Date: \_\_\_\_\_

# Trace it

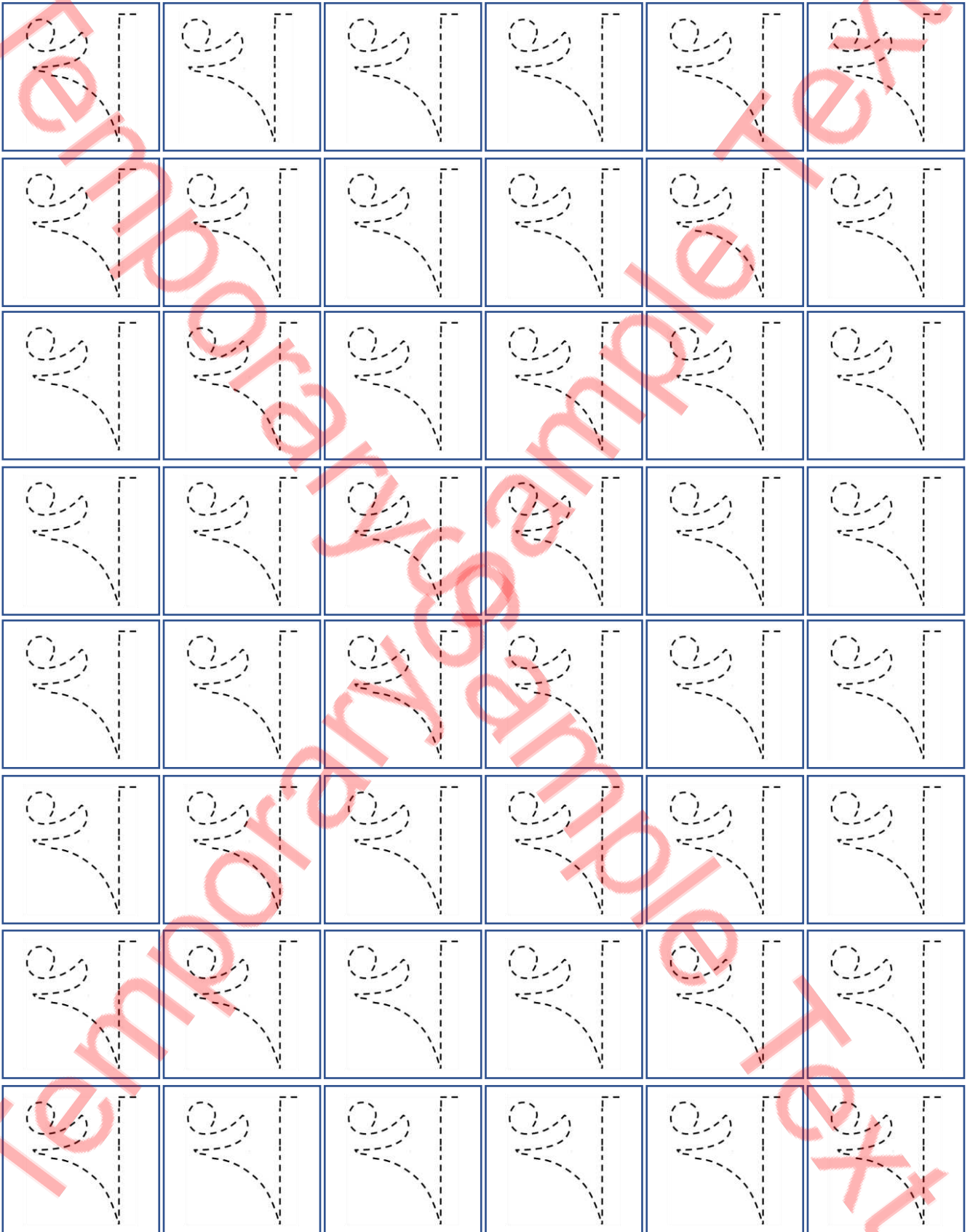

Student Name: \_\_\_\_\_

Verified By: \_\_\_\_\_

Class: \_\_\_\_\_

Date: \_\_\_\_\_



Write it

श	श	श	श	श	श

Student Name: \_\_\_\_\_

Verified By: \_\_\_\_\_

Class: \_\_\_\_\_

Date: \_\_\_\_\_

Copy Colour



Colour it



Write it

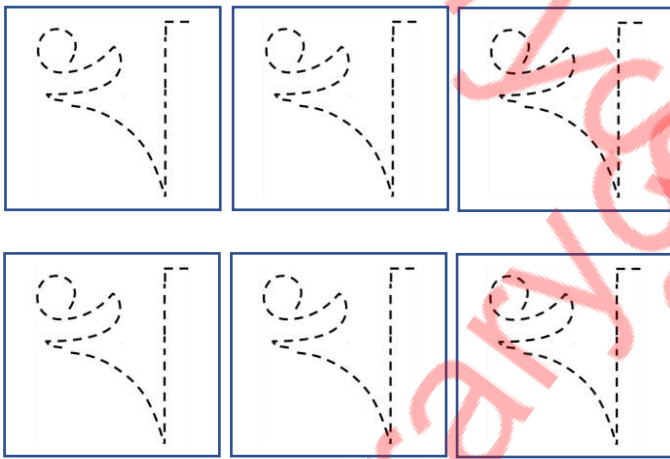

Find it

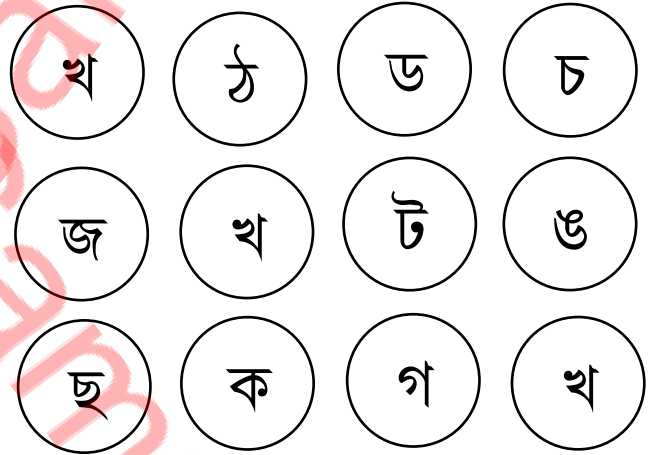

Connect the circle

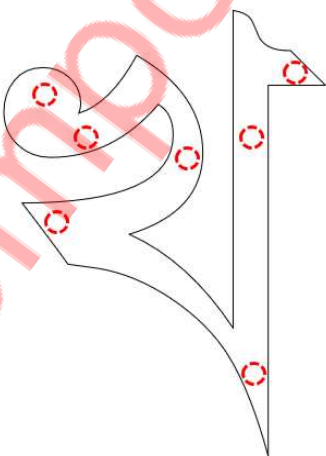

Do it

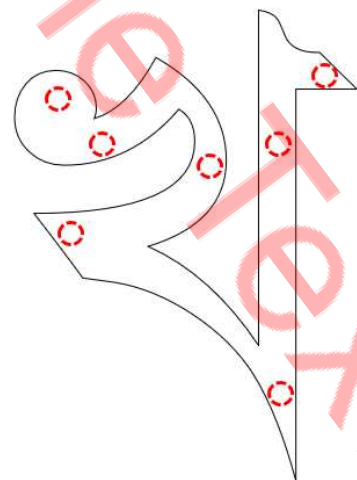

Student Name: \_\_\_\_\_

Verified By: \_\_\_\_\_

Class: \_\_\_\_\_

Date: \_\_\_\_\_

# Pick the Path Find the Correct Alphabet

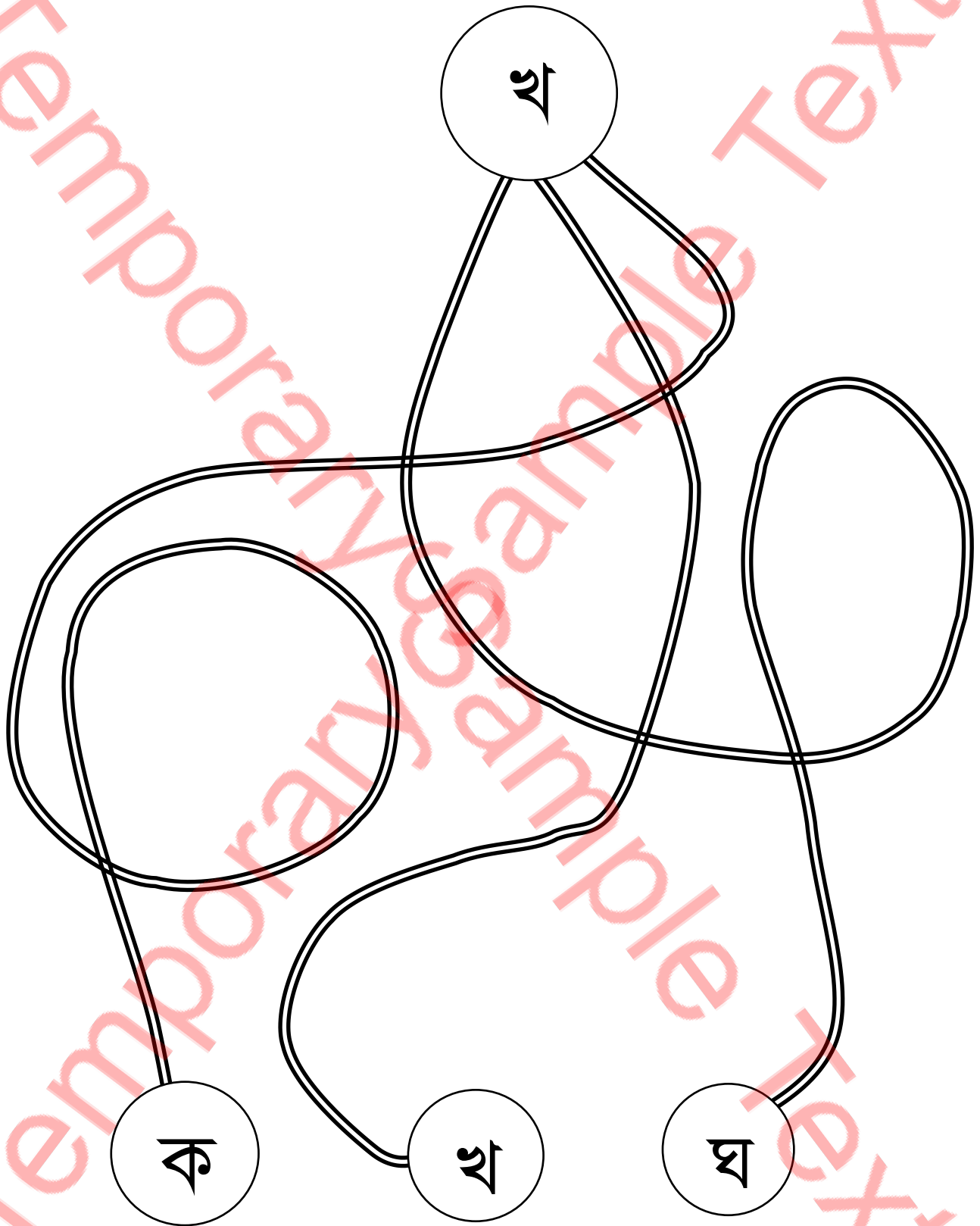

Student Name: \_\_\_\_\_

Verified By: \_\_\_\_\_

Class: \_\_\_\_\_

Date: \_\_\_\_\_

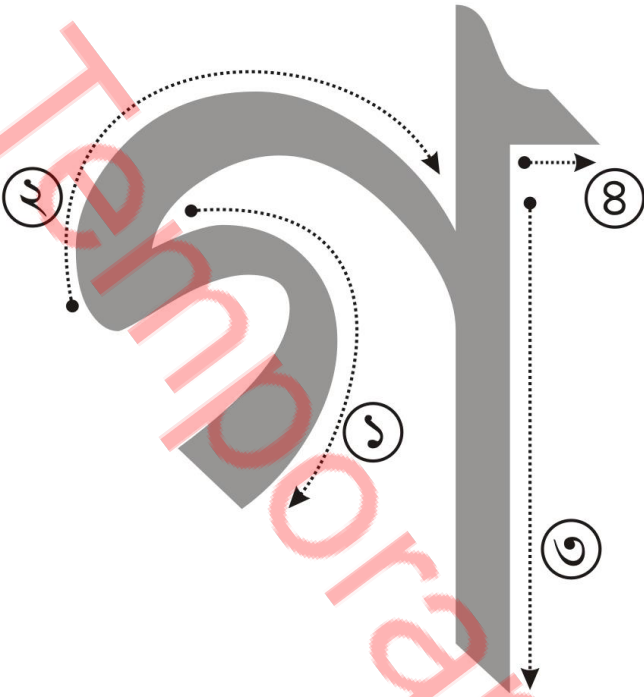

Follow the above steps

Colour it accordingly

ক	খ	গ	ঘ	ঙ	চ	ছ	জ
ঝ	ঞ	ট	ঠ	ড	ঢ	ণ	ত
থ	দ	ধ	ন	প	ফ	ব	ভ
ম	য	ষ	প্র	র	শ	ষ	স
হ	ক্ষ	ড়	ঢ়	য়	ং	ঃ	ঁ

Student Name: \_\_\_\_\_

Verified By: \_\_\_\_\_

Class: \_\_\_\_\_

Date: \_\_\_\_\_

## Trace It

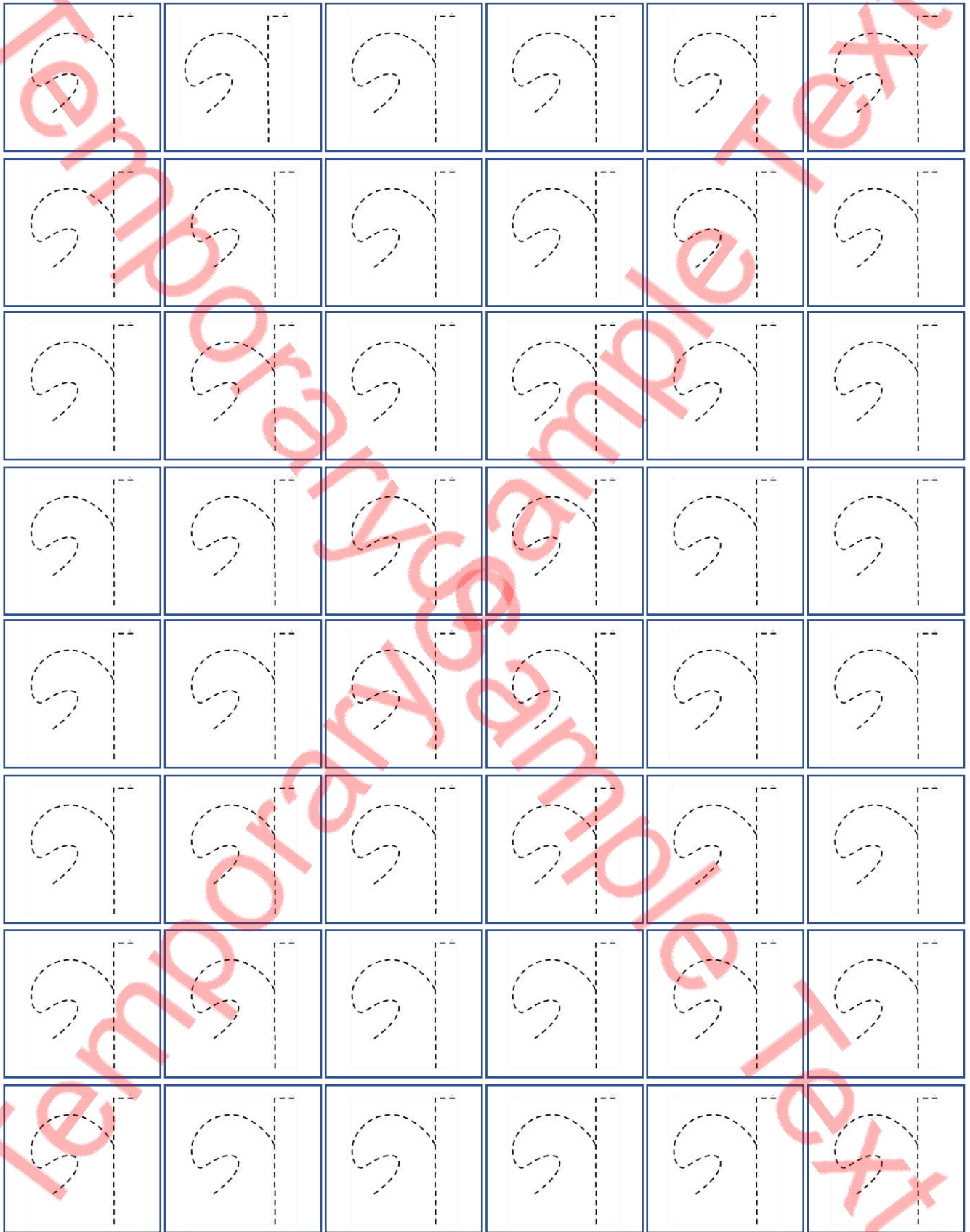

Student Name: \_\_\_\_\_

Verified By: \_\_\_\_\_

Class: \_\_\_\_\_

Date: \_\_\_\_\_



## Trace it

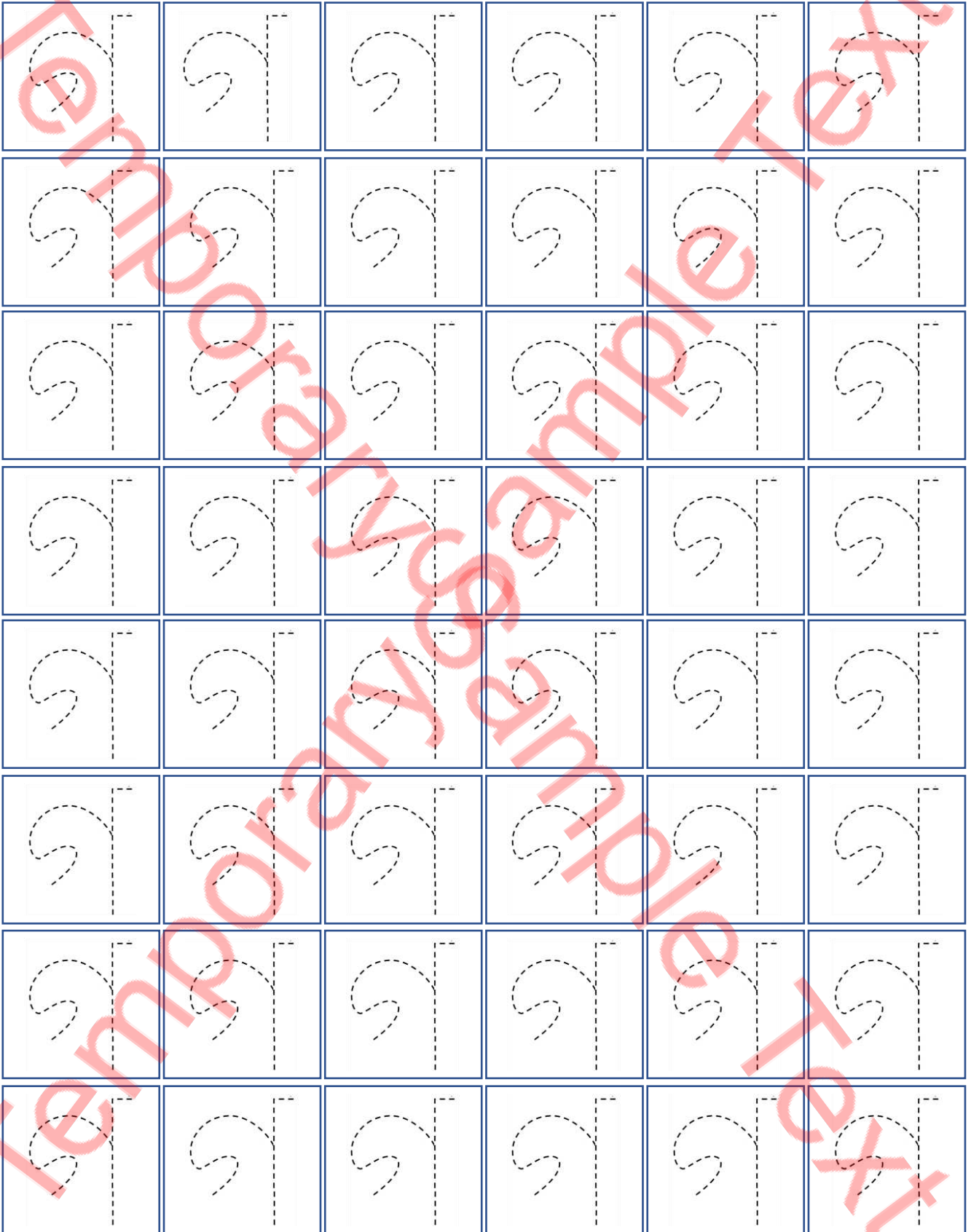

Student Name: \_\_\_\_\_

Verified By: \_\_\_\_\_

Class: \_\_\_\_\_

Date: \_\_\_\_\_

## Write it

र	र	र	र	र	र

Student Name: \_\_\_\_\_

Verified By: \_\_\_\_\_

Class: \_\_\_\_\_

Date: \_\_\_\_\_

Copy Colour



Colour it

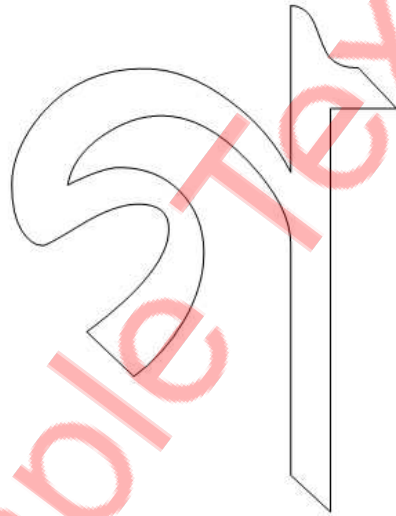

Write it

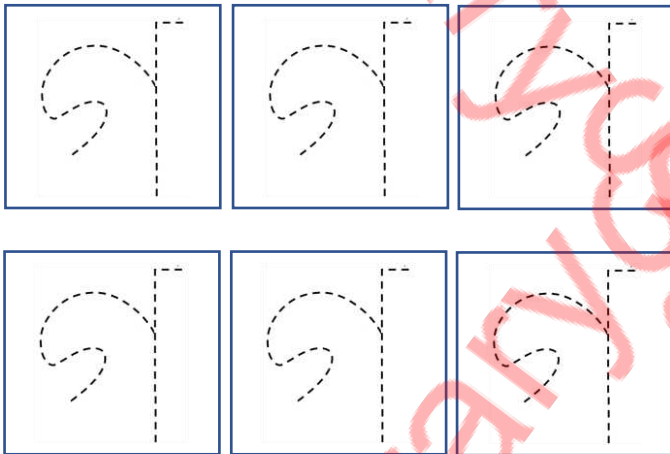

Find it

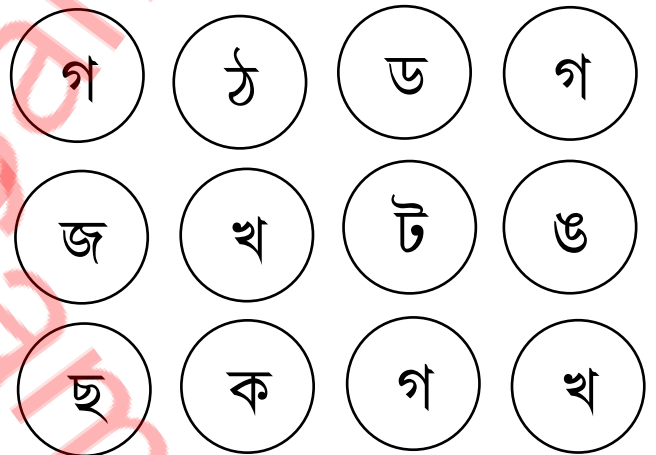

Connect the circle

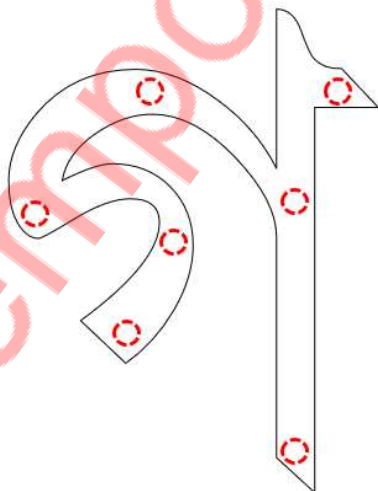

Do it

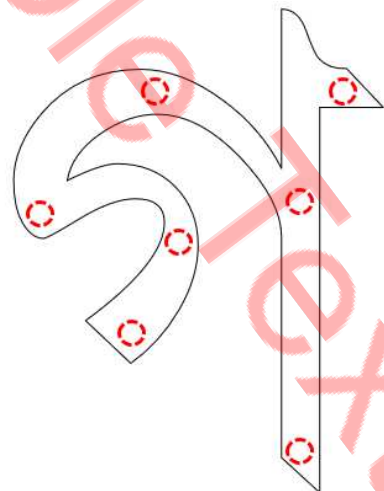

Student Name: \_\_\_\_\_

Verified By: \_\_\_\_\_

Class: \_\_\_\_\_

Date: \_\_\_\_\_



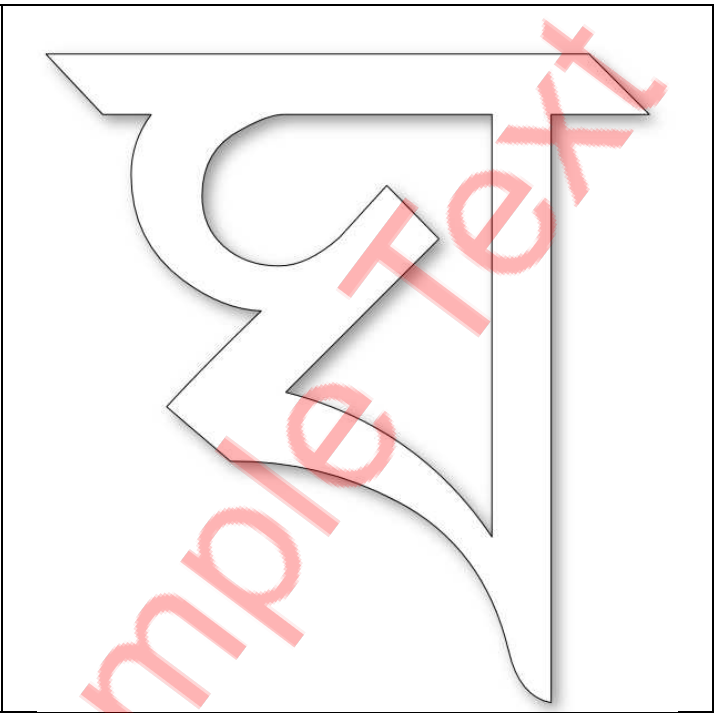
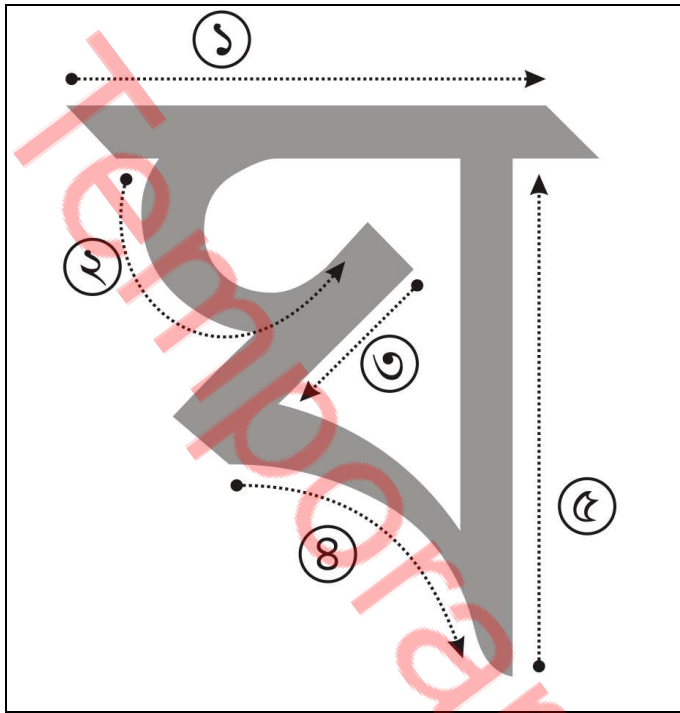

Follow the above steps

Colour it accordingly

ক	খ	গ	ঘ	ঙ	চ	ছ	জ
ঝ	ঞ	ট	ঠ	ড	ঢ	ণ	ত
থ	দ	ধ	ন	প	ফ	ব	ভ
ম	য	ষ	র	ৱ	শ	ষ	স
হ	ক্ষ	ড়	ঢ়	য়	ং	ঃ	ঁ

Student Name: _____	Verified By: _____
Class: _____	Date: _____



## Trace It



Student Name: \_\_\_\_\_

Verified By: \_\_\_\_\_

Class: \_\_\_\_\_

Date: \_\_\_\_\_

# Trace it



Student Name: \_\_\_\_\_

Verified By: \_\_\_\_\_

Class: \_\_\_\_\_

Date: \_\_\_\_\_

Write it

Student Name: \_\_\_\_\_

Verified By: \_\_\_\_\_

Class: \_\_\_\_\_

Date: \_\_\_\_\_

Copy Colour



Colour it



Write it

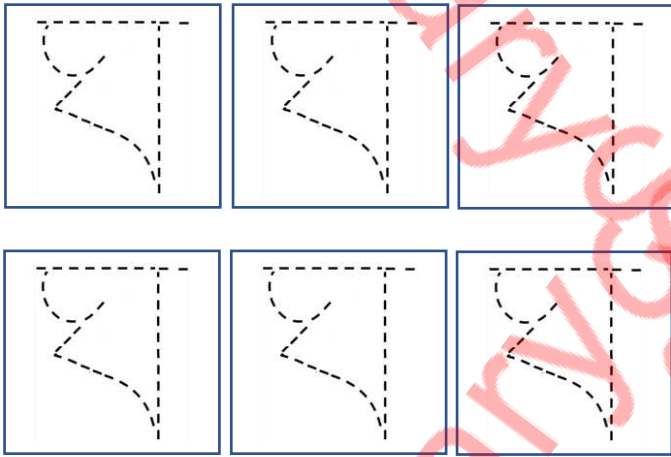

Find it

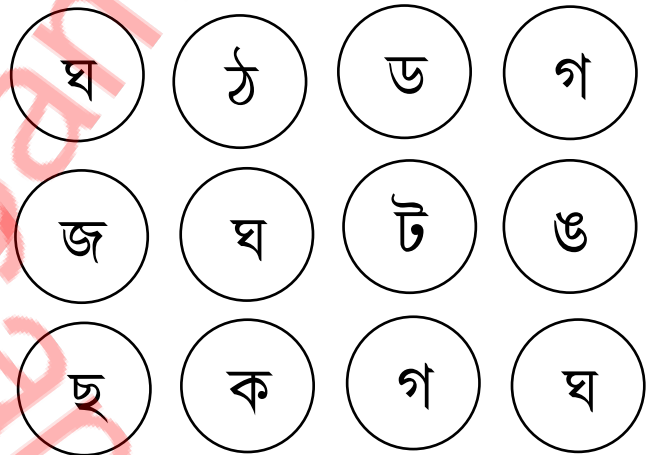

Connect the circle

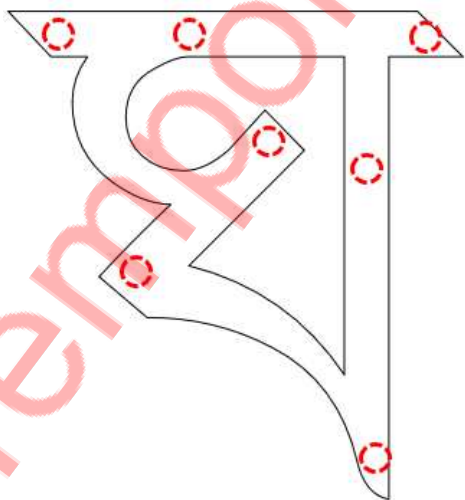

Do it

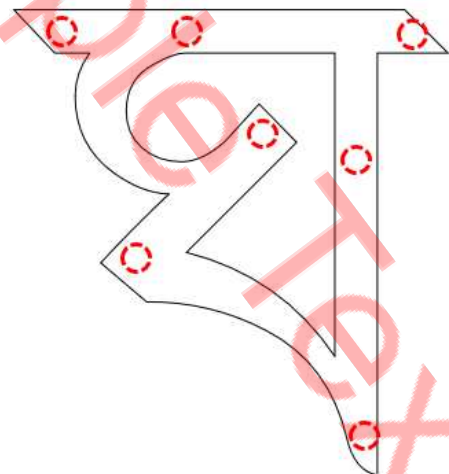

Student Name: \_\_\_\_\_

Verified By: \_\_\_\_\_

Class: \_\_\_\_\_

Date: \_\_\_\_\_





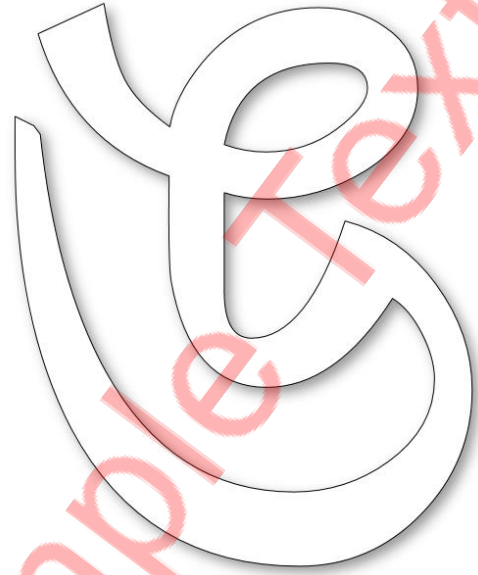
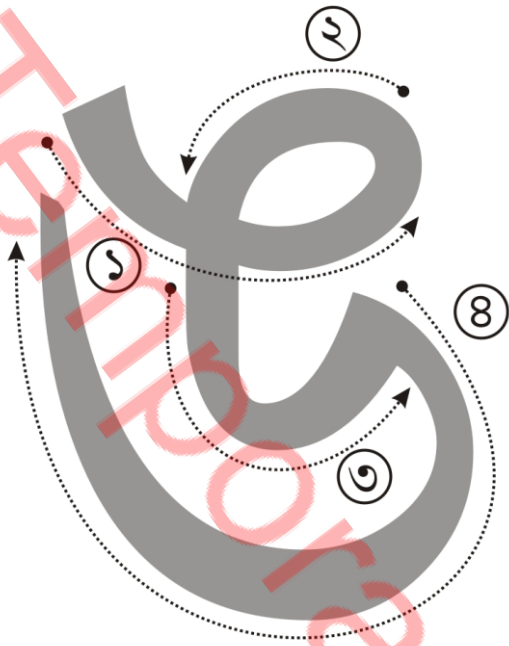

Follow the above steps

Colour it accordingly

ক	খ	গ	ঘ	ঙ	চ	ছ	জ
ঝ	ঞ	ট	ঠ	ড	ঢ	ণ	ত
থ	দ	ধ	ন	প	ফ	ব	ভ
ম	য	ষ	প্র	শ	ষ	ষ	স
হ	ক্ষ	ডে	ডে	য়	ং	ং	ং

Student Name: \_\_\_\_\_

Verified By: \_\_\_\_\_

Class: \_\_\_\_\_

Date: \_\_\_\_\_

## Trace It



Student Name: \_\_\_\_\_

Verified By: \_\_\_\_\_

Class: \_\_\_\_\_

Date: \_\_\_\_\_

# Trace it





Student Name: \_\_\_\_\_

Verified By: \_\_\_\_\_

Class: \_\_\_\_\_

Date: \_\_\_\_\_

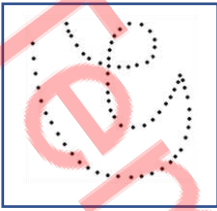
# Write it

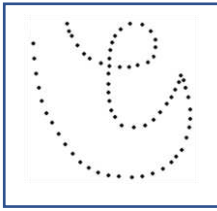
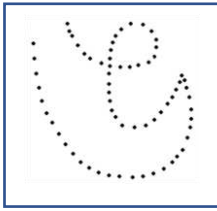
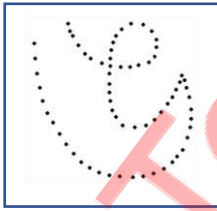
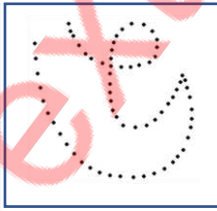
Student Name: \_\_\_\_\_

Verified By: \_\_\_\_\_

Class: \_\_\_\_\_

Date: \_\_\_\_\_

Copy Colour



Colour it

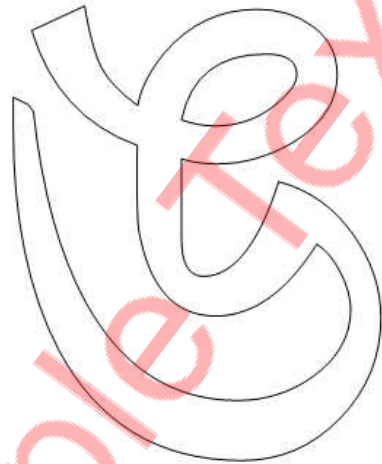

Write it

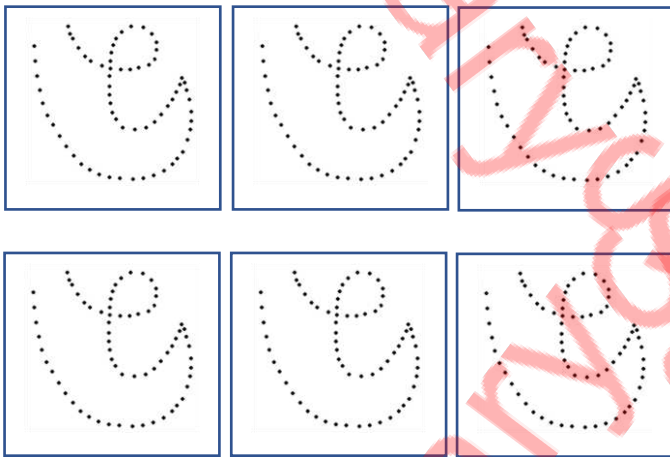

Find it

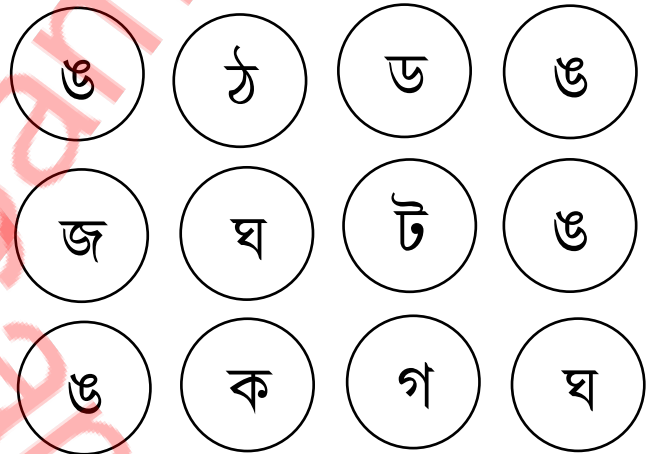

Connect the circle

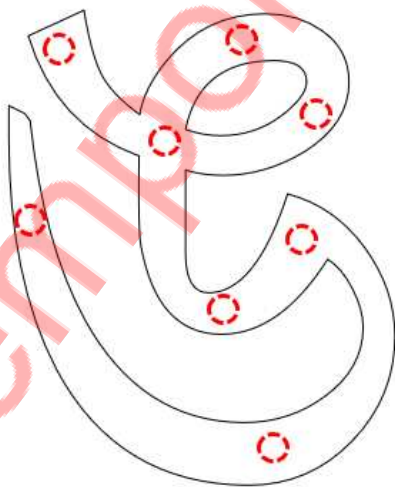

Do it

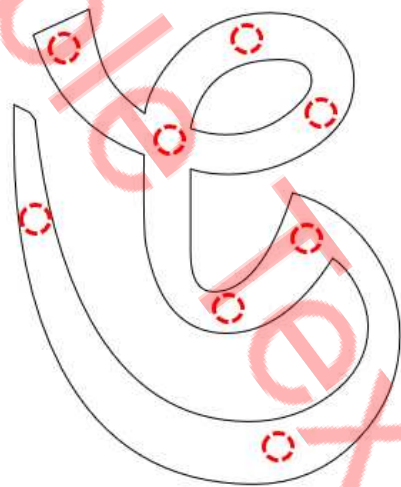

Student Name: \_\_\_\_\_

Verified By: \_\_\_\_\_

Class: \_\_\_\_\_

Date: \_\_\_\_\_



# Pick the Path Find the Correct Alphabet

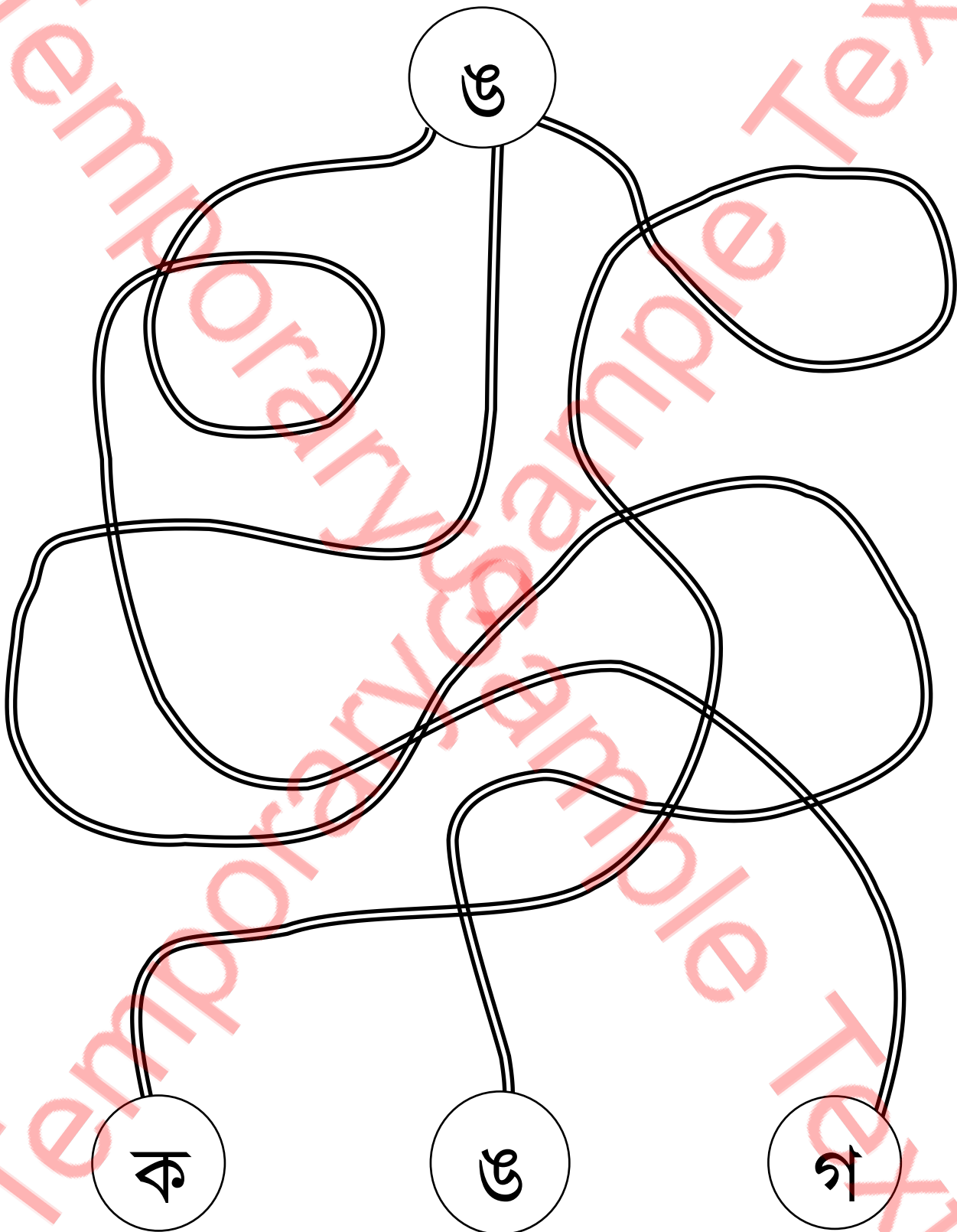

Student Name: \_\_\_\_\_

Verified By: \_\_\_\_\_

Class: \_\_\_\_\_

Date: \_\_\_\_\_



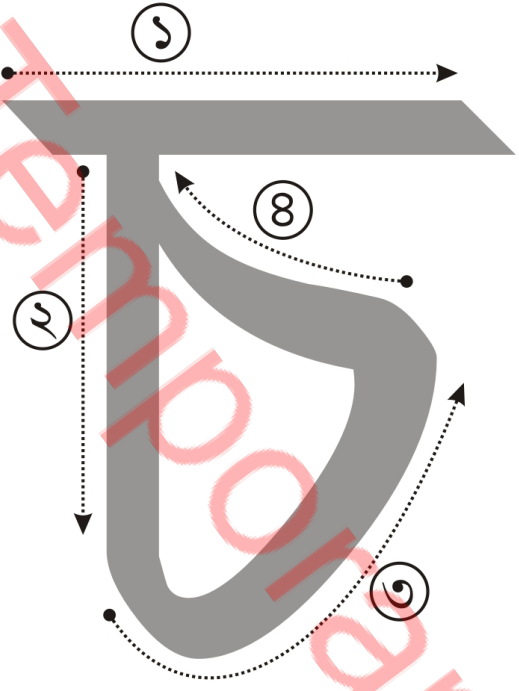

Follow the above steps



Colour it accordingly

ক	খ	গ	ঘ	ঙ	চ	ছ	জ
ঝ	ঞ	ট	ঠ	ড	ঢ	ণ	ত
থ	দ	ধ	ন	প	ফ	ব	ভ
ম	য	ষ	র	ষ	শ	ষ	স
হ	ক্ষ	ড়	ঢ়	য়	ং	ঃ	ঁ

Student Name: \_\_\_\_\_

Verified By: \_\_\_\_\_

Class: \_\_\_\_\_

Date: \_\_\_\_\_

# Trace It



Student Name: \_\_\_\_\_

Verified By: \_\_\_\_\_

Class: \_\_\_\_\_

Date: \_\_\_\_\_

# Trace it



Student Name: \_\_\_\_\_

Verified By: \_\_\_\_\_

Class: \_\_\_\_\_

Date: \_\_\_\_\_

# Write it

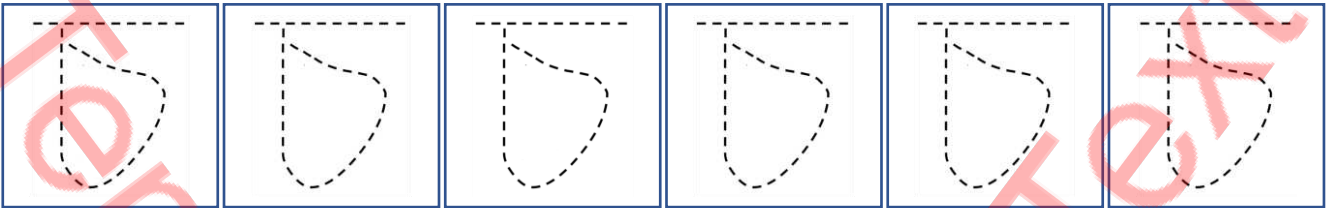



Student Name: \_\_\_\_\_

Verified By: \_\_\_\_\_

Class: \_\_\_\_\_

Date: \_\_\_\_\_

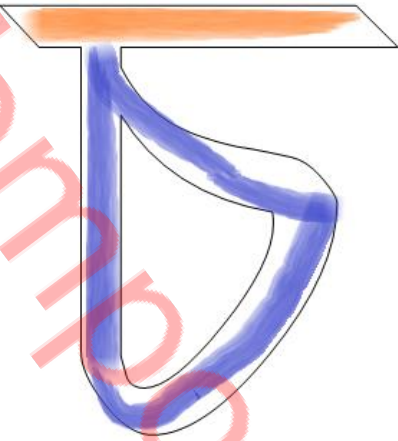
Copy Colour



Colour it

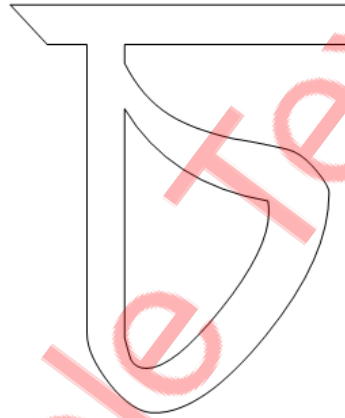

Write it

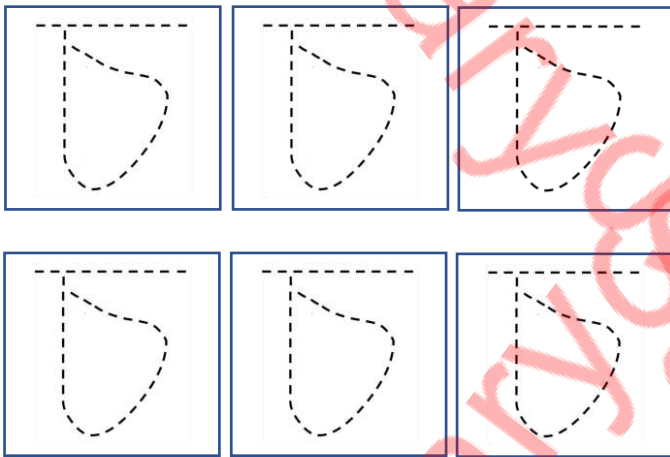

Find it

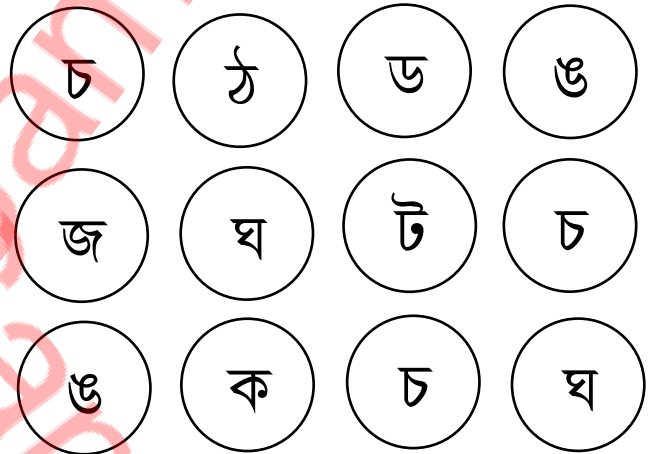

Connect the circle

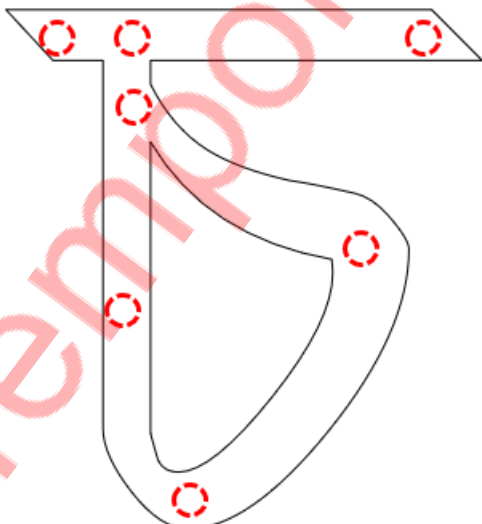

Do it

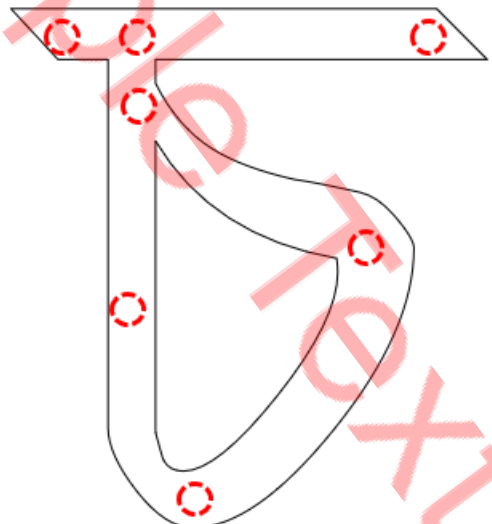

Student Name: \_\_\_\_\_

Class: \_\_\_\_\_

Verified By: \_\_\_\_\_

Date: \_\_\_\_\_

# Pick the Path Find the Correct Alphabet

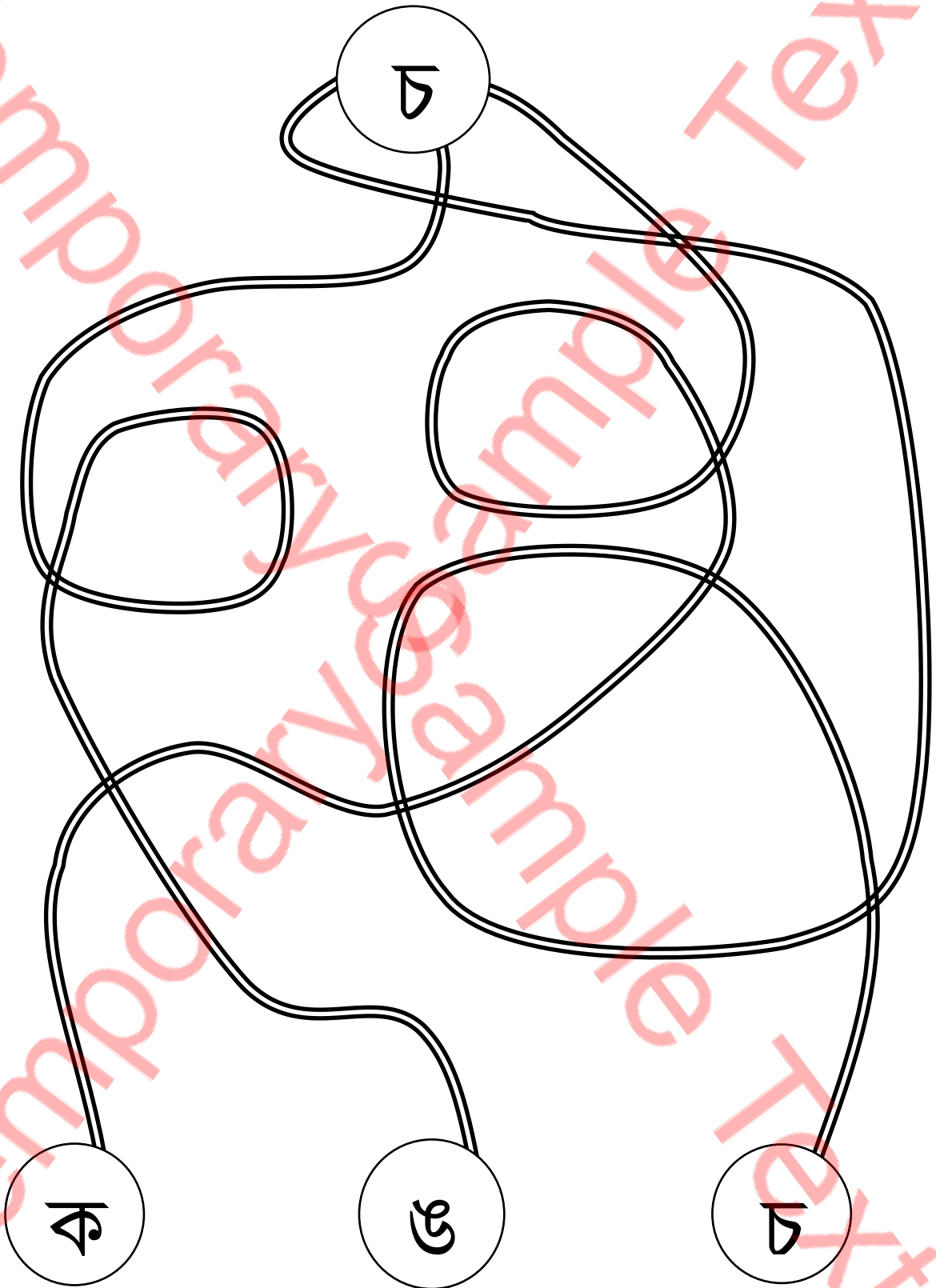

Student Name: \_\_\_\_\_

Verified By: \_\_\_\_\_

Class: \_\_\_\_\_

Date: \_\_\_\_\_



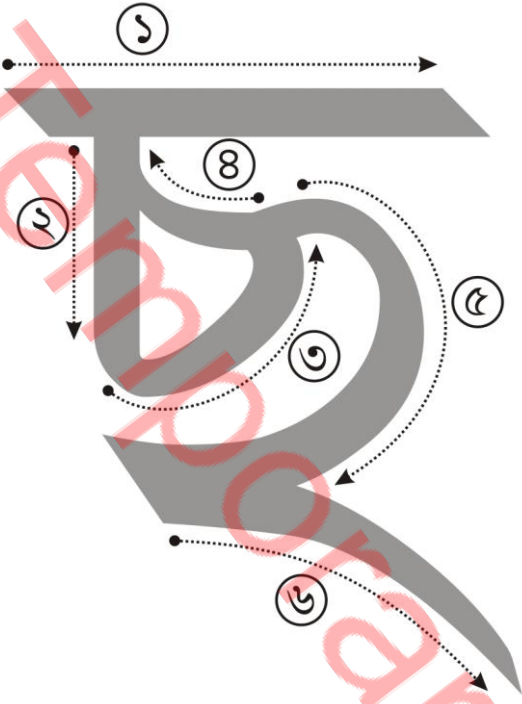

Follow the above steps



Colour it accordingly

ক	খ	গ	ঘ	ঙ	চ	ছ	জ
ঝ	ঞ	ট	ঠ	ড	ঢ	ণ	ত
থ	দ	ধ	ন	প	ফ	ব	ভ
ম	য	ষ	প্র	র	শ	ষ	স
হ	ক্ষ	ড়	ঢ়	য়	ং	ঃ	ঁ

Student Name: \_\_\_\_\_

Verified By: \_\_\_\_\_

Class: \_\_\_\_\_

Date: \_\_\_\_\_

## Trace It

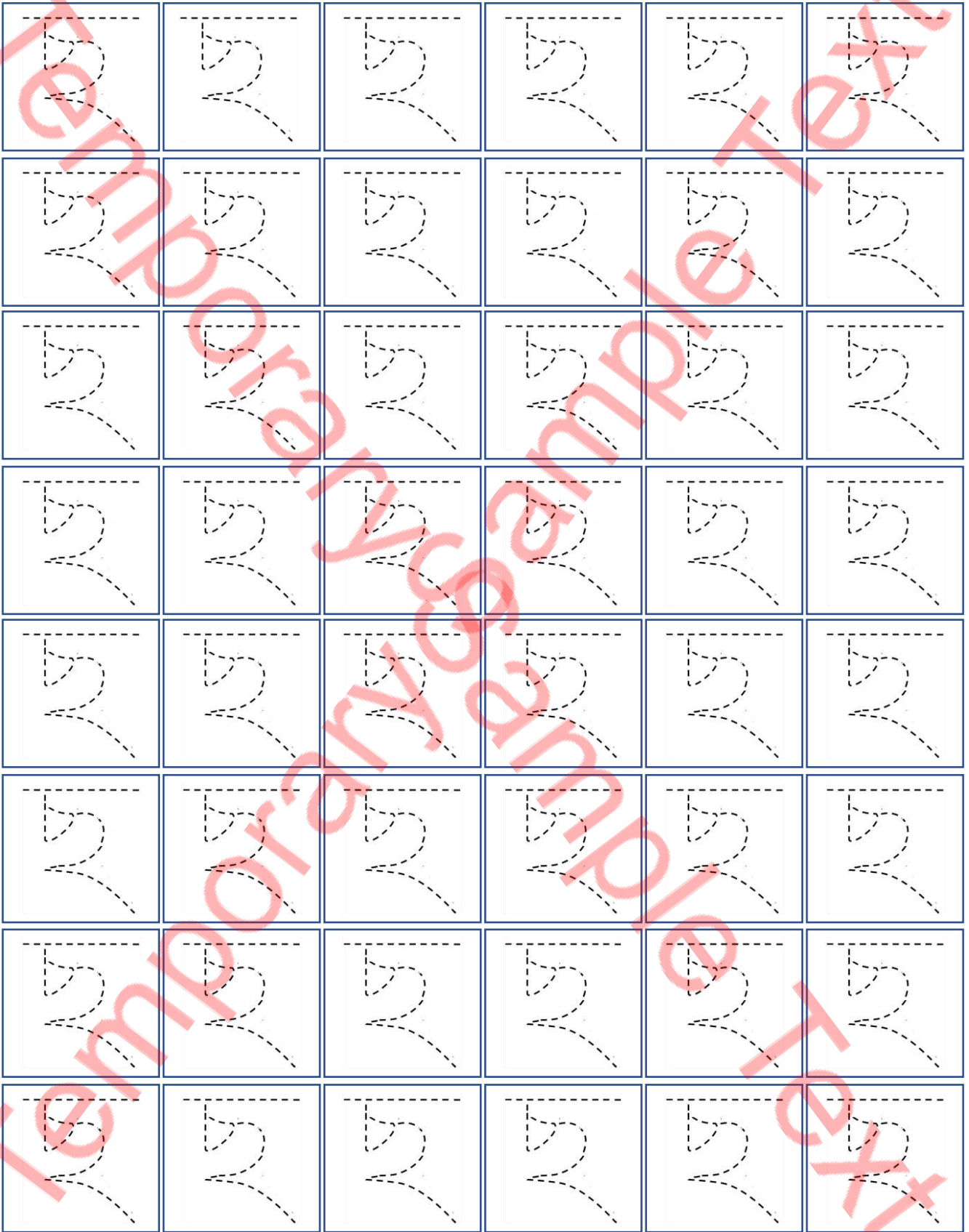

Student Name: \_\_\_\_\_

Verified By: \_\_\_\_\_

Class: \_\_\_\_\_

Date: \_\_\_\_\_

# Trace it



Student Name: \_\_\_\_\_

Verified By: \_\_\_\_\_

Class: \_\_\_\_\_

Date: \_\_\_\_\_

Write it

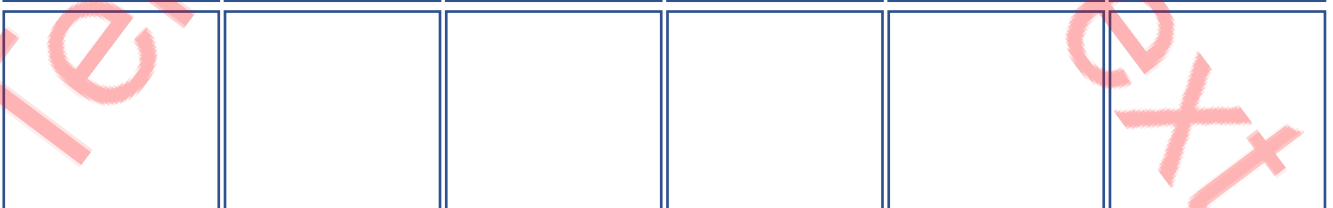
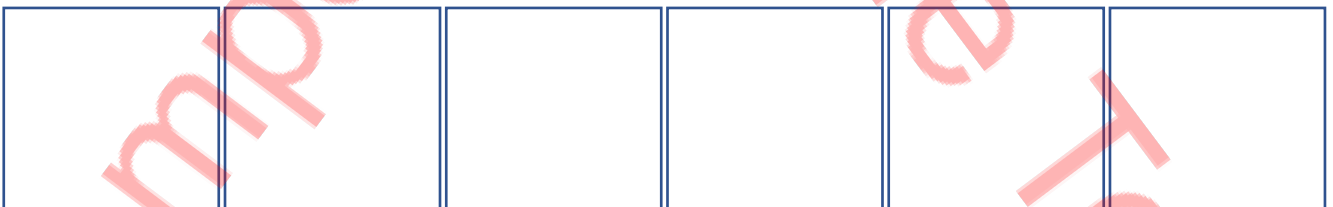
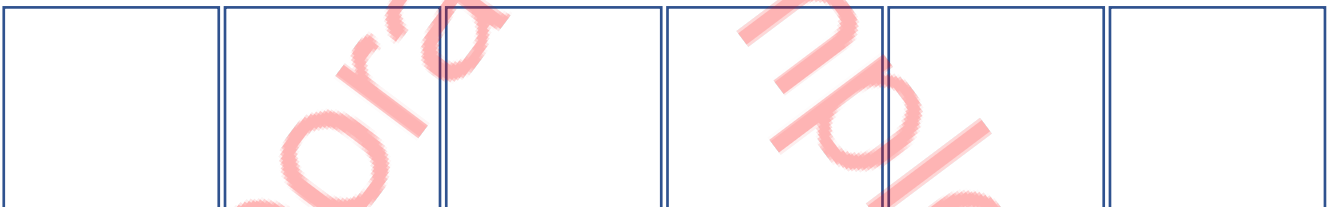
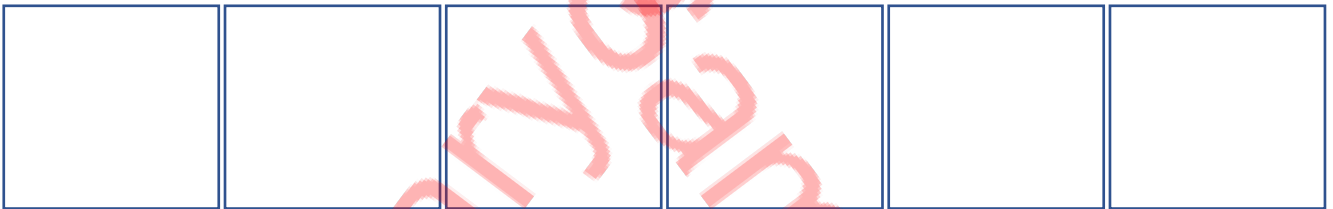
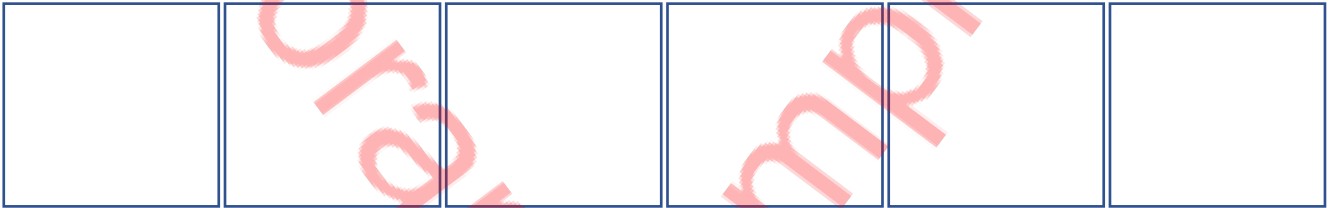
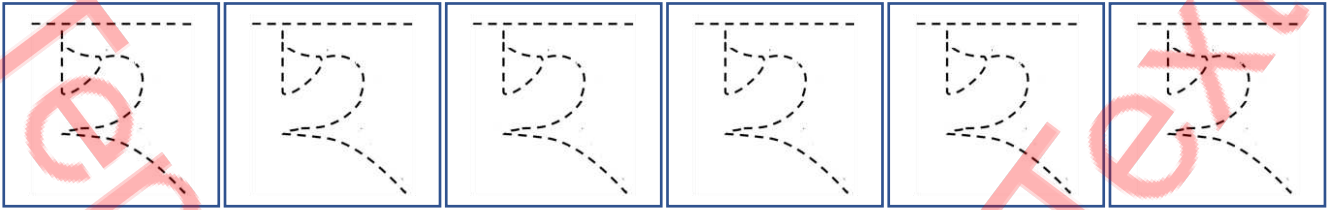

Student Name: \_\_\_\_\_

Verified By: \_\_\_\_\_

Class: \_\_\_\_\_

Date: \_\_\_\_\_

Copy Colour

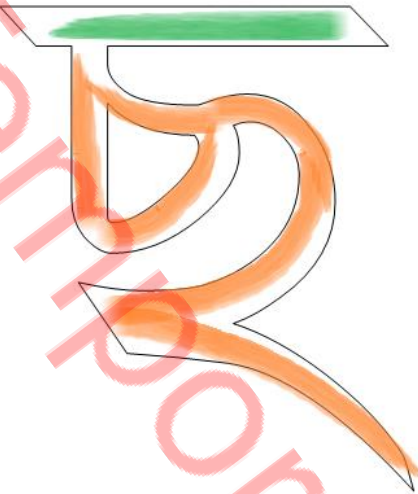

Colour it



Write it

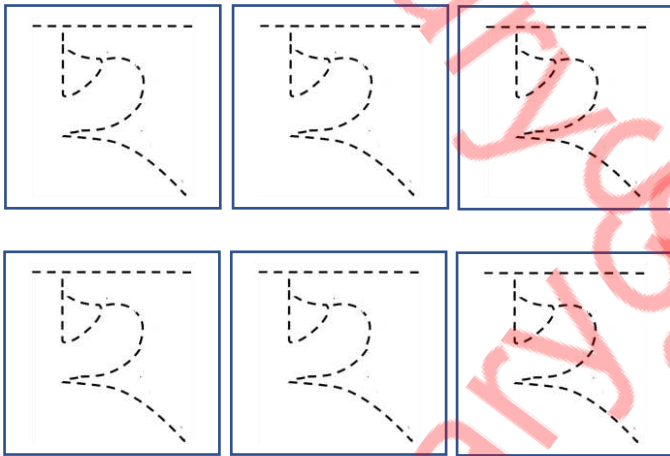

Find it

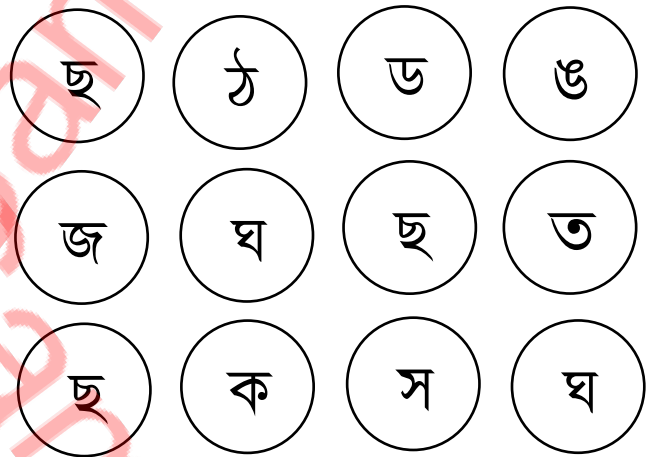

Connect the circle

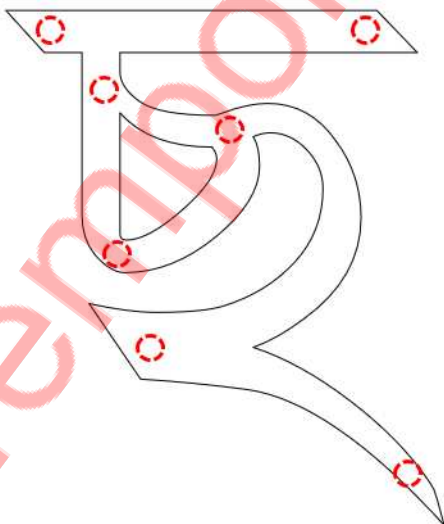

Do it

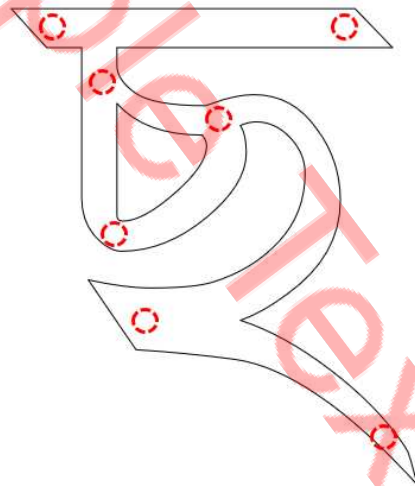

Student Name: \_\_\_\_\_

Verified By: \_\_\_\_\_

Class: \_\_\_\_\_

Date: \_\_\_\_\_

# Pick the Path Find the Correct Alphabet

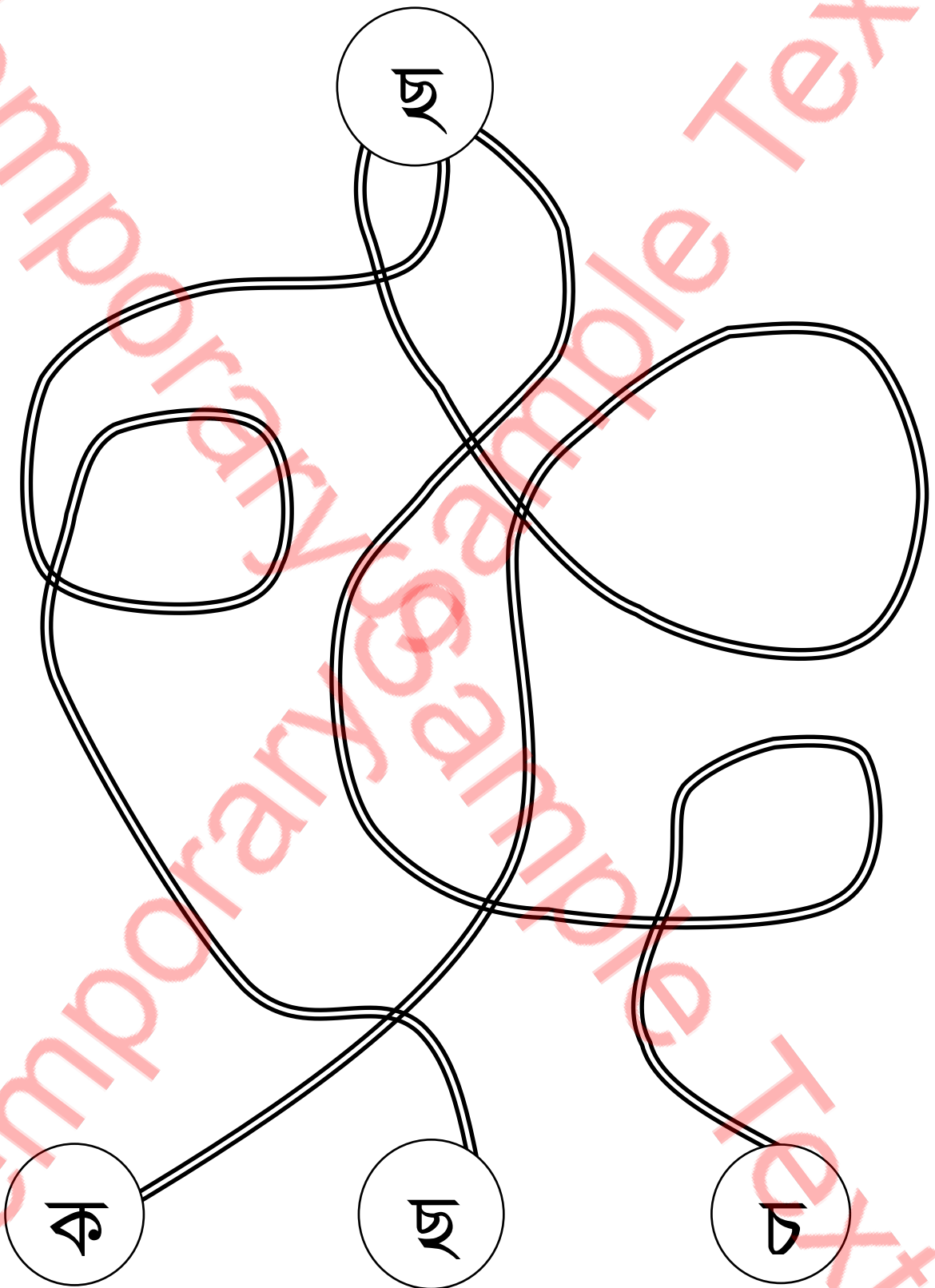

Student Name: \_\_\_\_\_

Verified By: \_\_\_\_\_

Class: \_\_\_\_\_

Date: \_\_\_\_\_



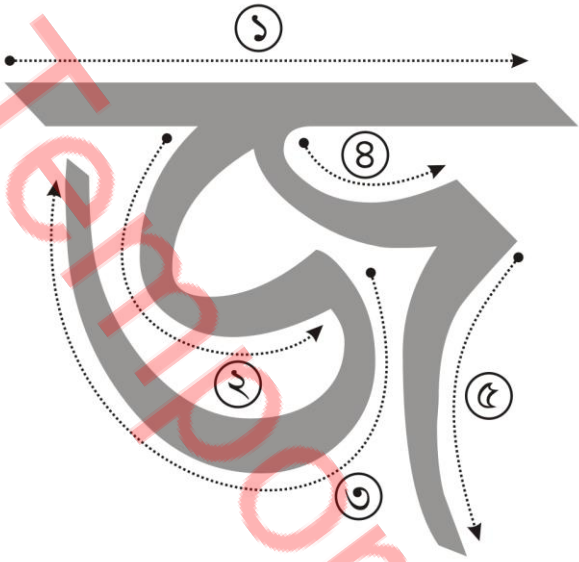

Follow the above steps



Colour it accordingly

ক	খ	গ	ঘ	ঙ	চ	ছ	জ
ঝ	ঞ	ট	ঠ	ড	ঢ	ণ	ত
থ	দ	ধ	ন	প	ফ	ব	ভ
ম	য	ষ	প্র	র	শ	ষ	স
হ	ক্ষ	ড়	ঢ়	য়	ং	ঃ	ঁ

Student Name: \_\_\_\_\_

Verified By: \_\_\_\_\_

Class: \_\_\_\_\_

Date: \_\_\_\_\_

## Trace It

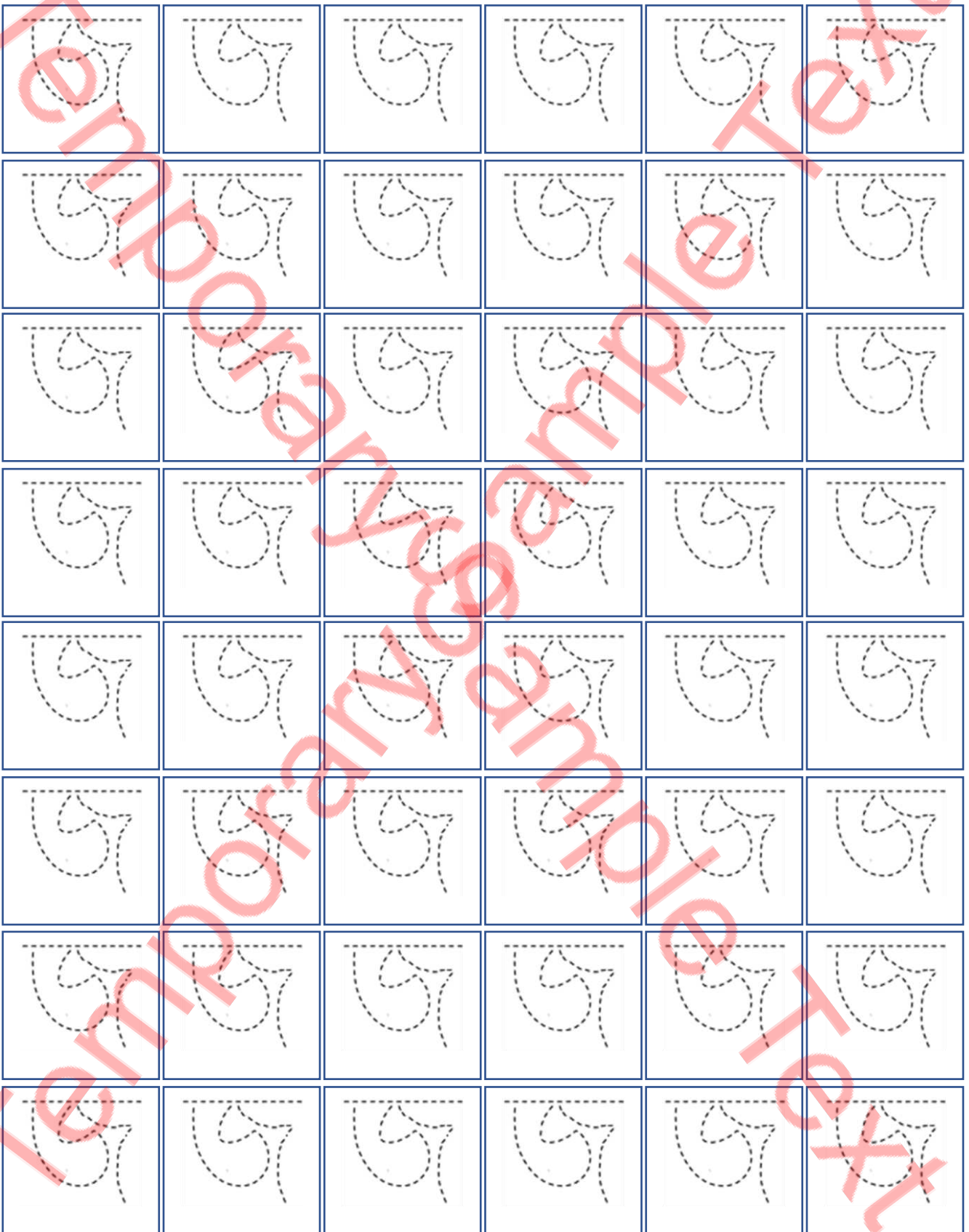

Student Name: \_\_\_\_\_

Verified By: \_\_\_\_\_

Class: \_\_\_\_\_

Date: \_\_\_\_\_

# Trace it

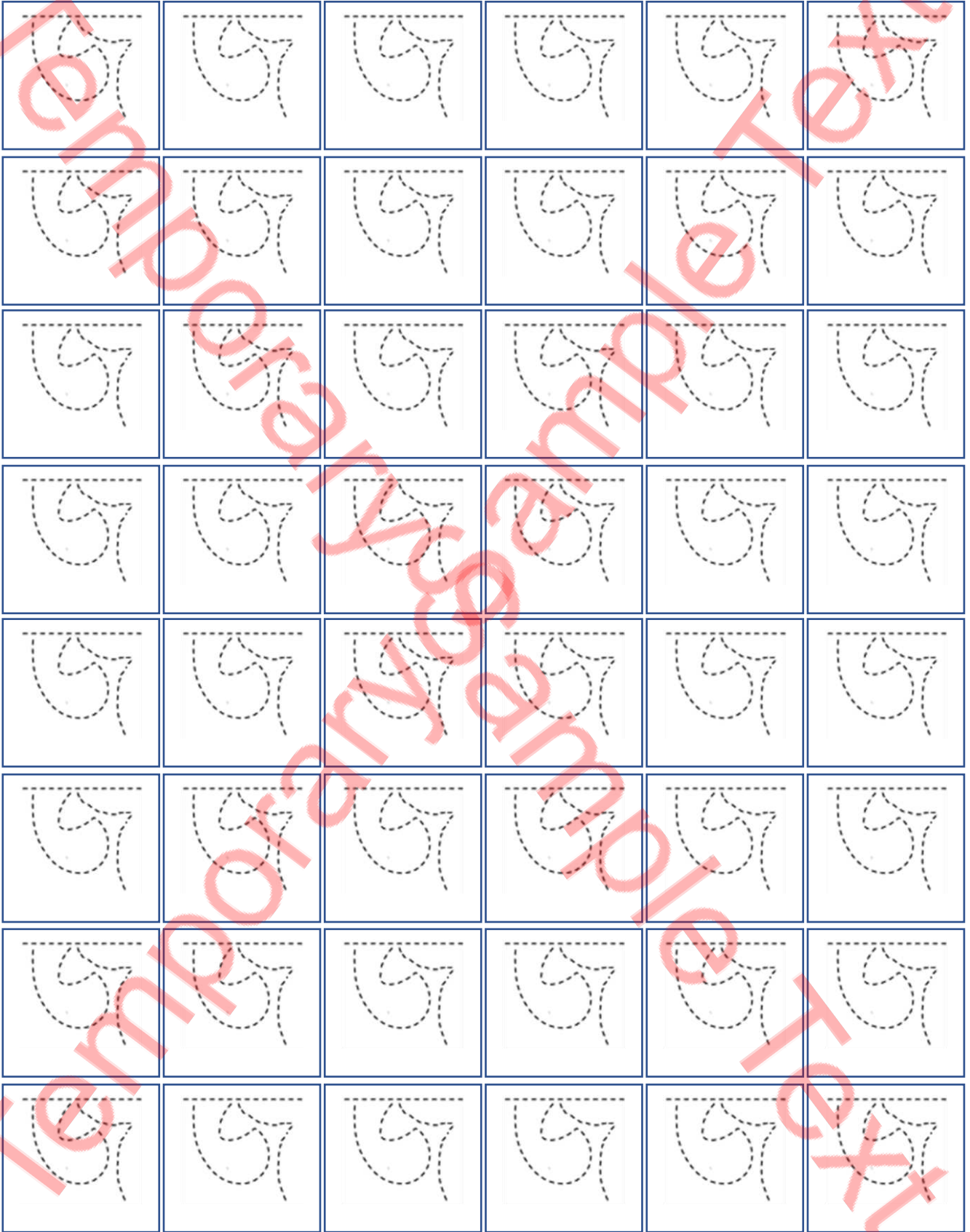

Student Name: \_\_\_\_\_

Verified By: \_\_\_\_\_

Class: \_\_\_\_\_

Date: \_\_\_\_\_

Write it

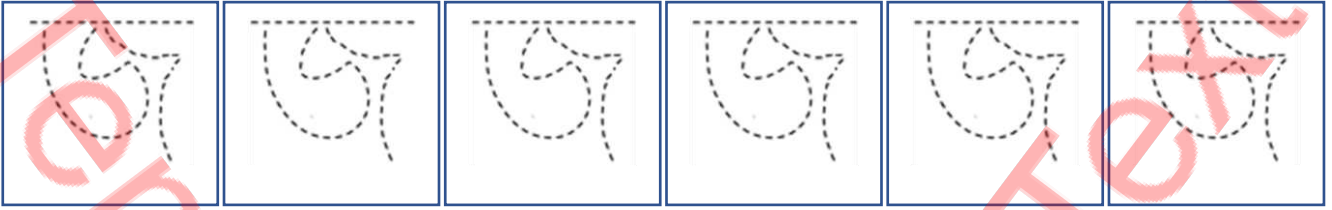



Student Name: \_\_\_\_\_

Verified By: \_\_\_\_\_

Class: \_\_\_\_\_

Date: \_\_\_\_\_

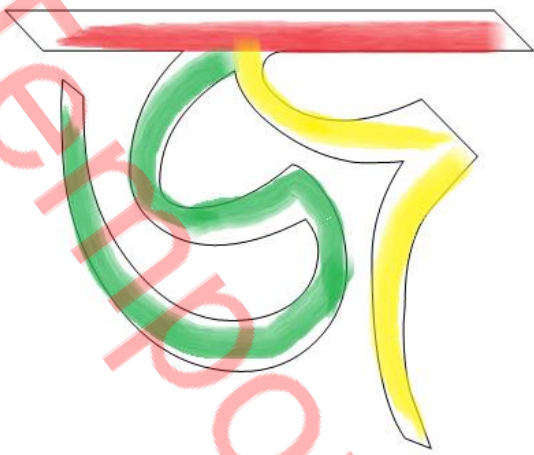
Copy Colour



Colour it

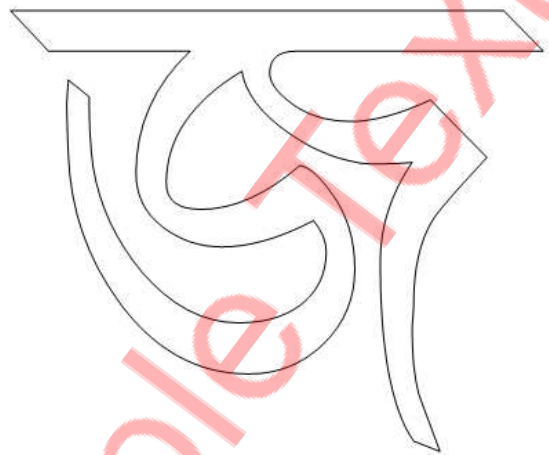

Write it

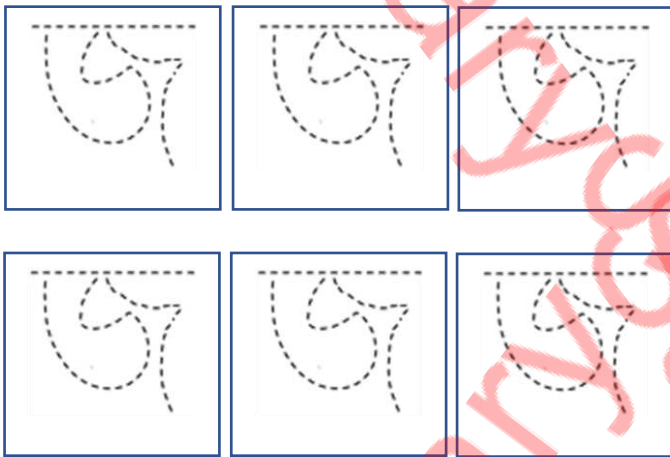

Find it



Connect the circle

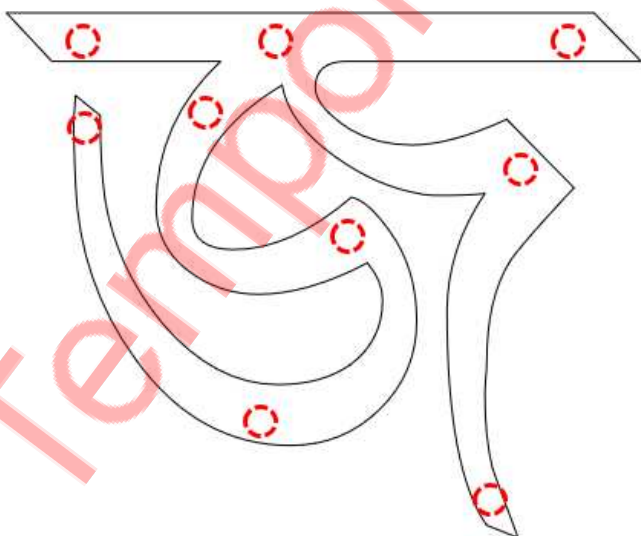

Do it

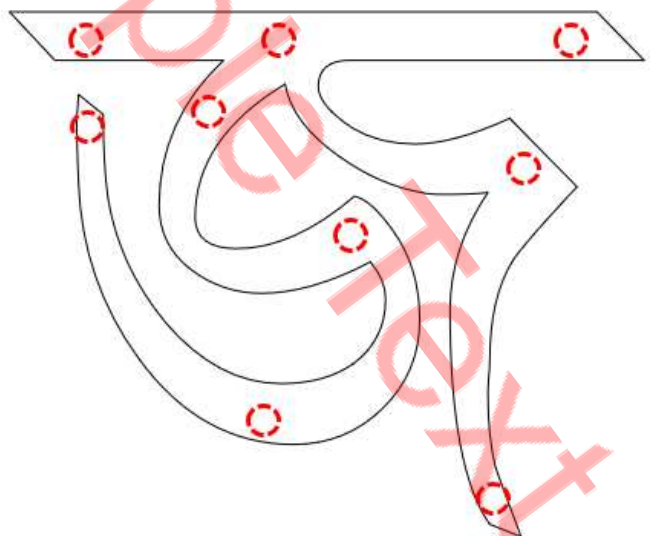

Student Name: \_\_\_\_\_

Verified By: \_\_\_\_\_

Class: \_\_\_\_\_

Date: \_\_\_\_\_



# Pick the Path Find the Correct Alphabet

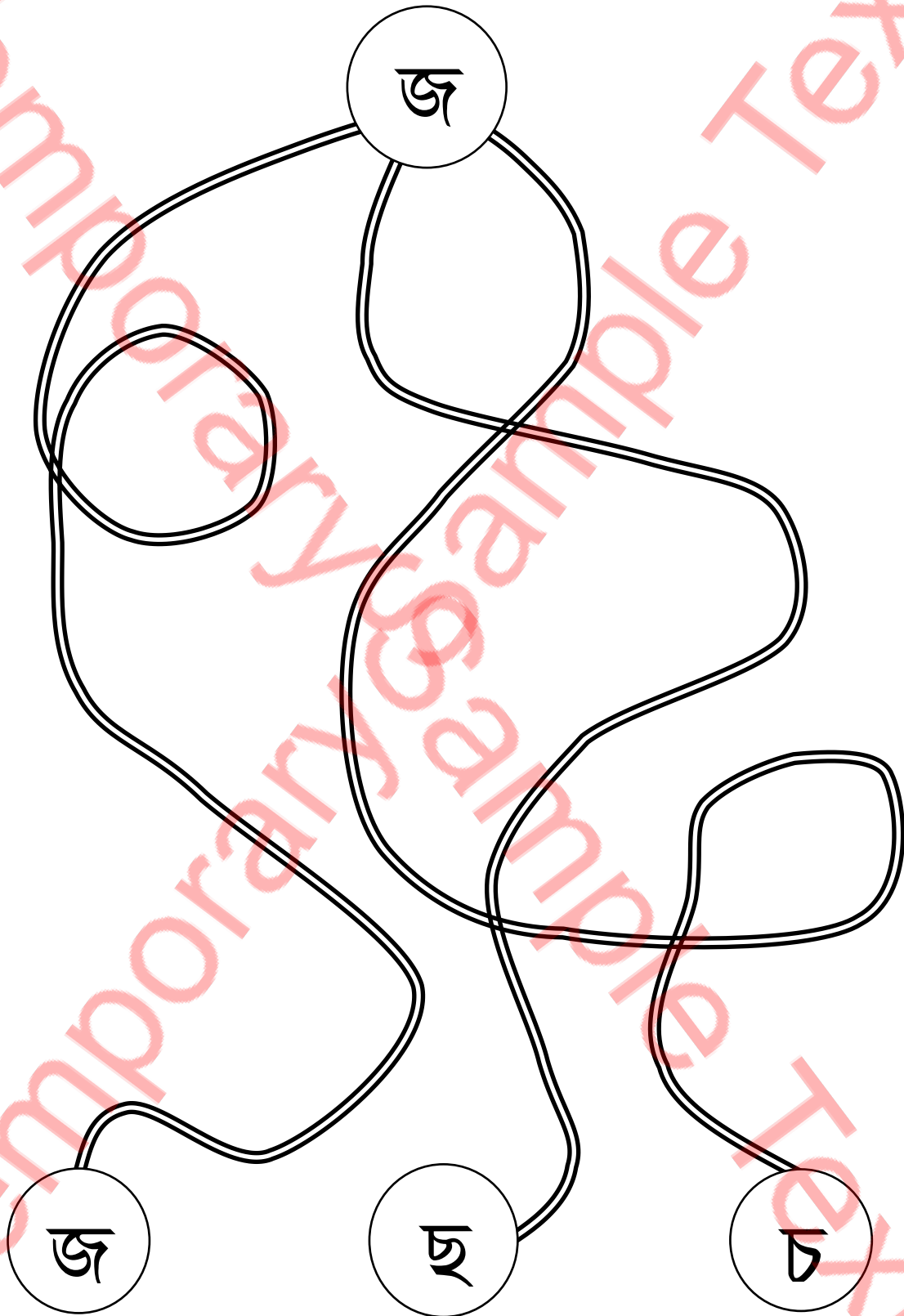

Student Name: \_\_\_\_\_

Verified By: \_\_\_\_\_

Class: \_\_\_\_\_

Date: \_\_\_\_\_



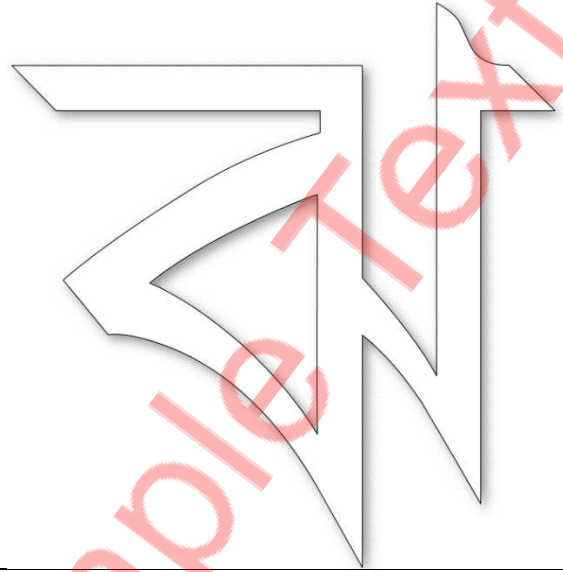
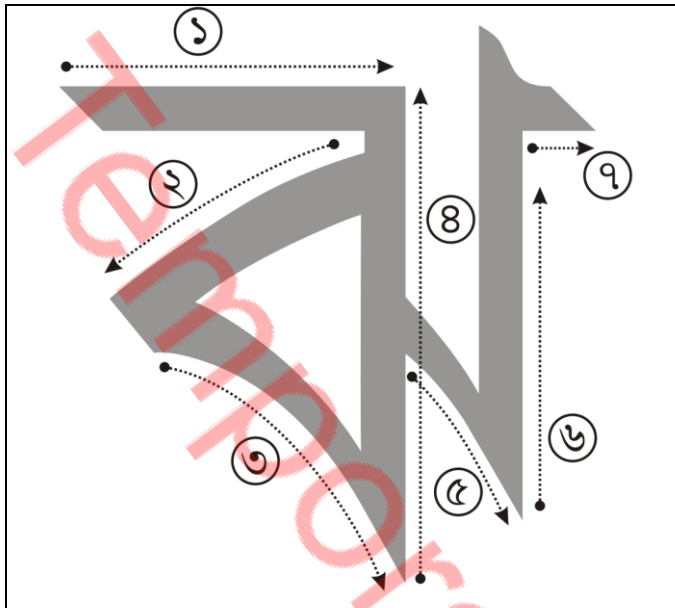

Follow the above steps

Colour it accordingly

ক	খ	গ	ঘ	ঙ	চ	ছ	জ
ষ	ঞ	ট	ঠ	ড	ঢ	ণ	ত
থ	দ	ধ	ন	প	ফ	ব	ভ
ম	য	র	ল	শ	ষ	স	
হ	ক্ষ	ড়	ঢ়	য়	ং	ঃ	ঁ

Student Name: \_\_\_\_\_

Verified By: \_\_\_\_\_

Class: \_\_\_\_\_

Date: \_\_\_\_\_

# Trace It

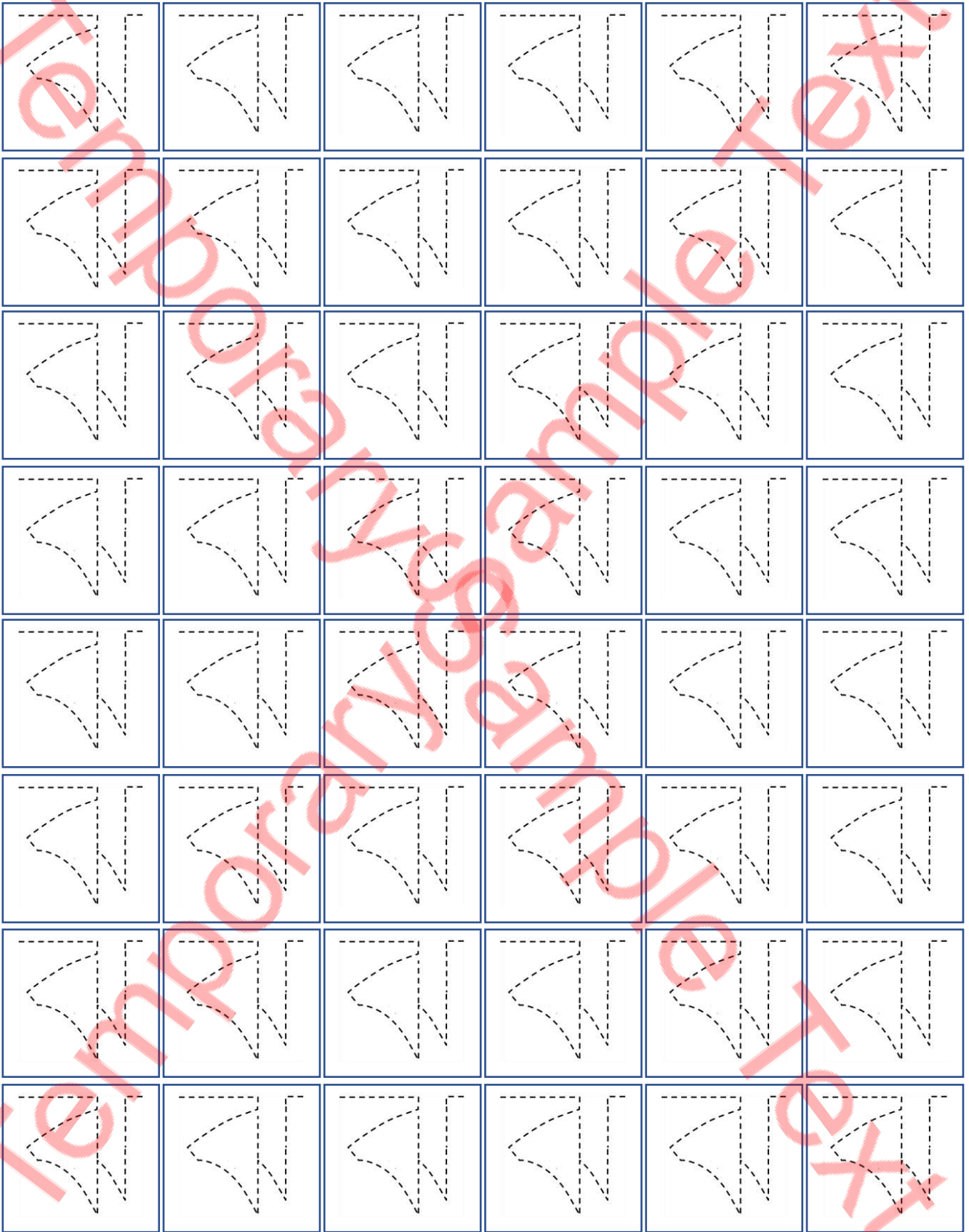

Student Name: \_\_\_\_\_

Verified By: \_\_\_\_\_

Class: \_\_\_\_\_

Date: \_\_\_\_\_

# Trace it

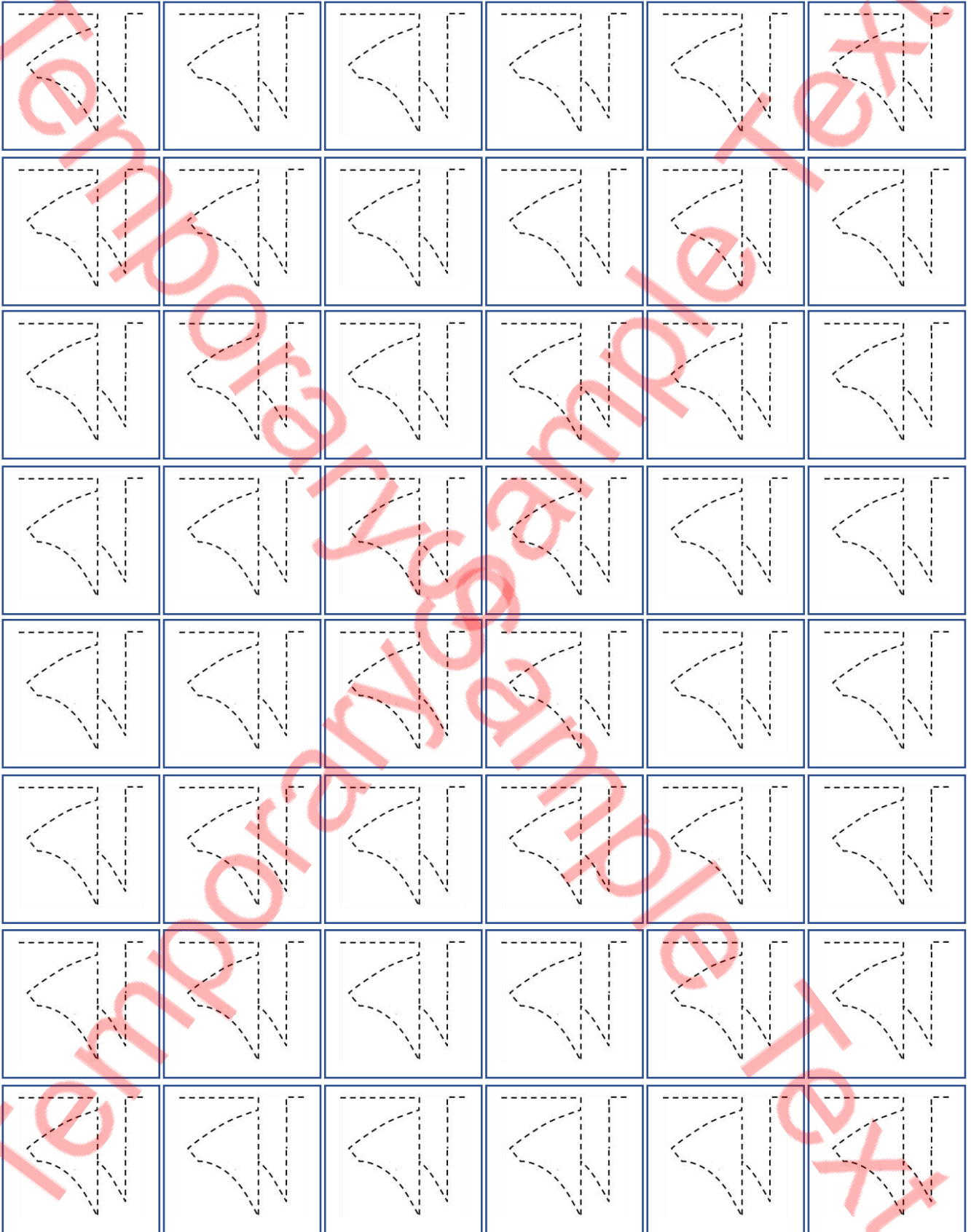

Student Name: \_\_\_\_\_

Verified By: \_\_\_\_\_

Class: \_\_\_\_\_

Date: \_\_\_\_\_

# Write it

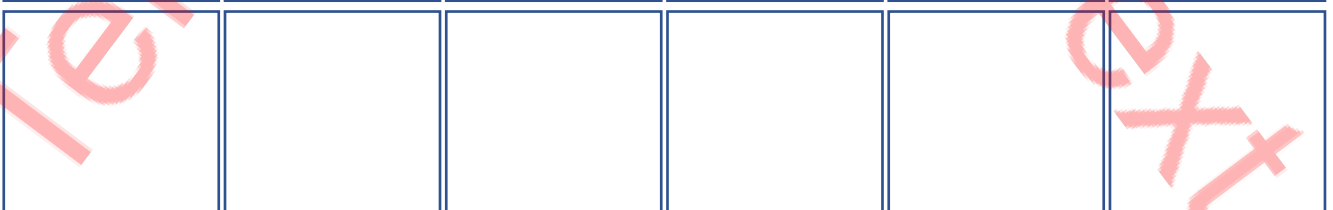
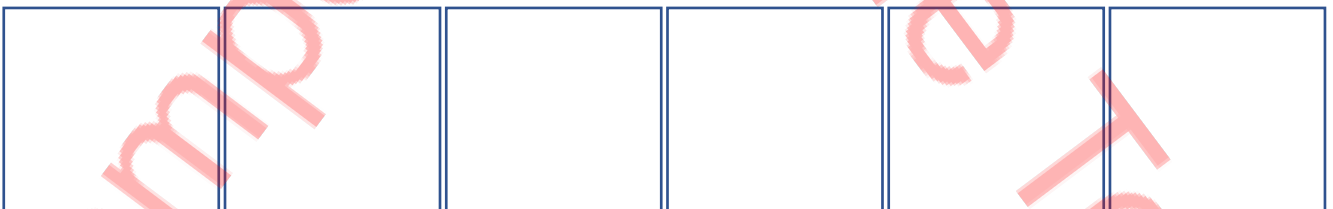
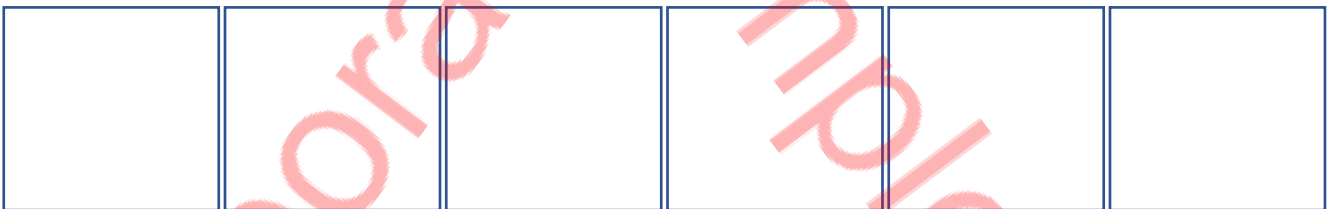
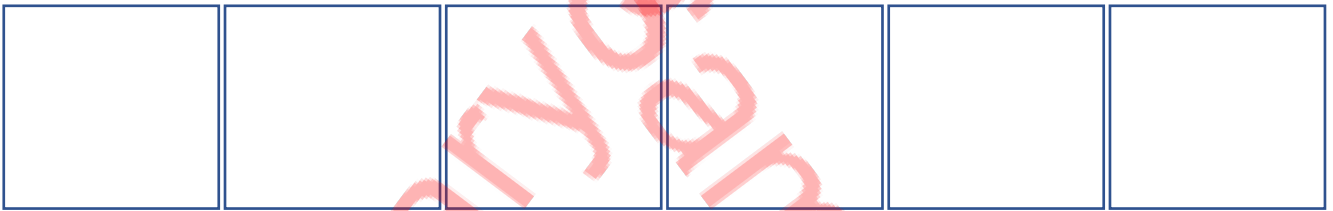
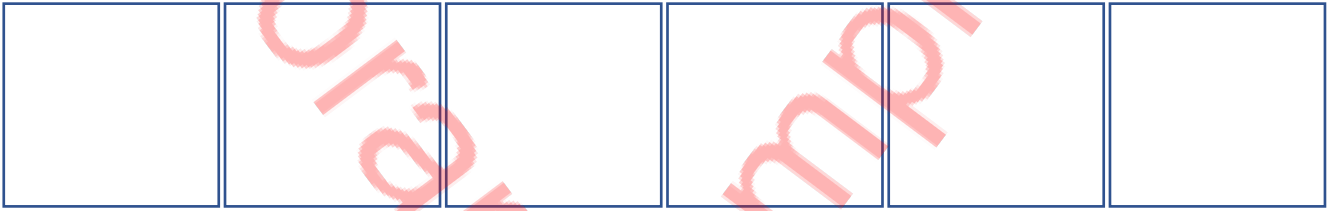
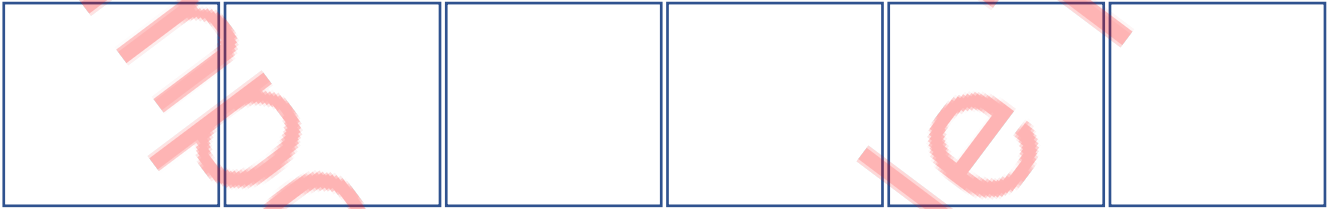
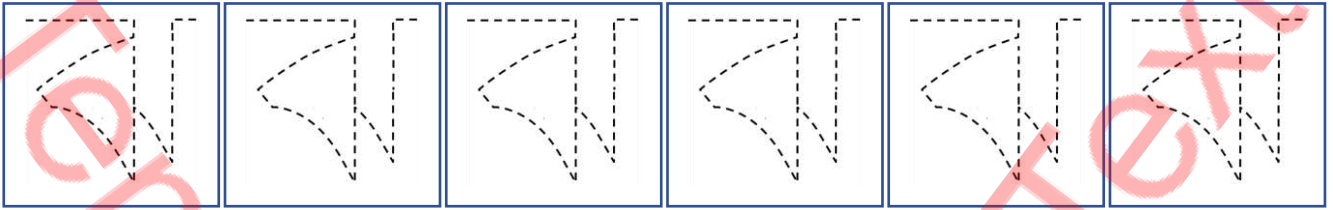

Student Name: \_\_\_\_\_

Verified By: \_\_\_\_\_

Class: \_\_\_\_\_

Date: \_\_\_\_\_

Copy Colour

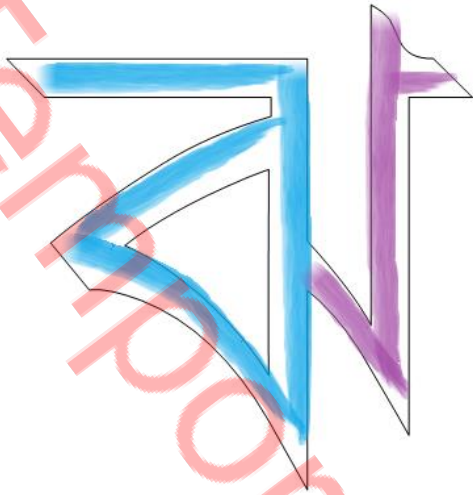

Colour it

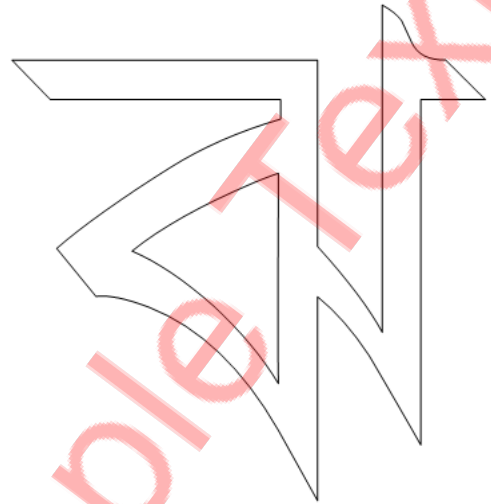

Write it

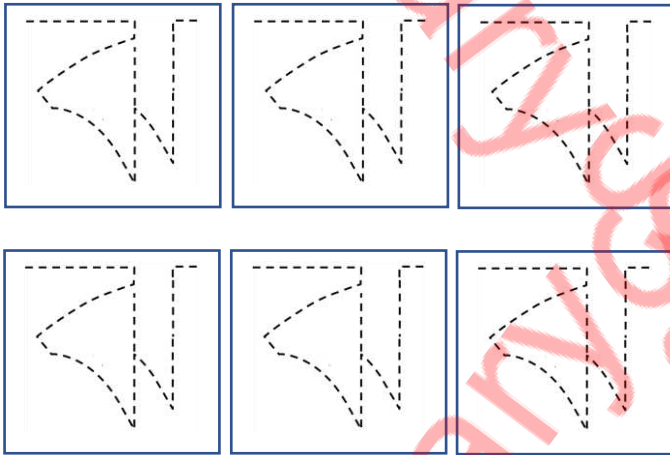

Find it



Connect the circle

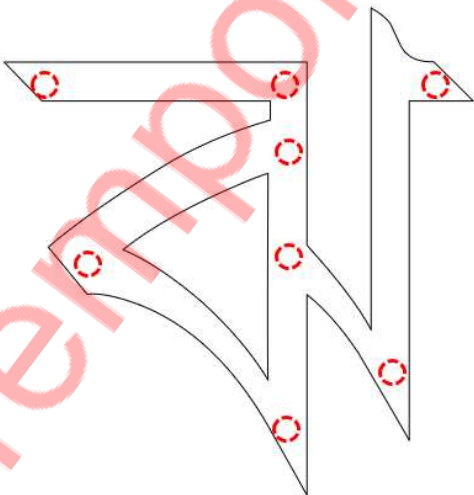

Do it

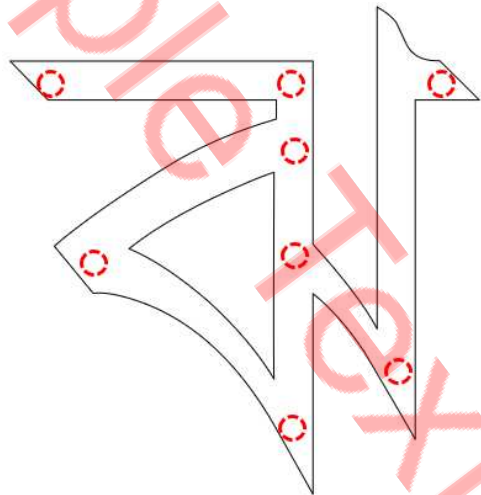

Student Name: \_\_\_\_\_

Verified By: \_\_\_\_\_

Class: \_\_\_\_\_

Date: \_\_\_\_\_

# Pick the Path Find the Correct Alphabet

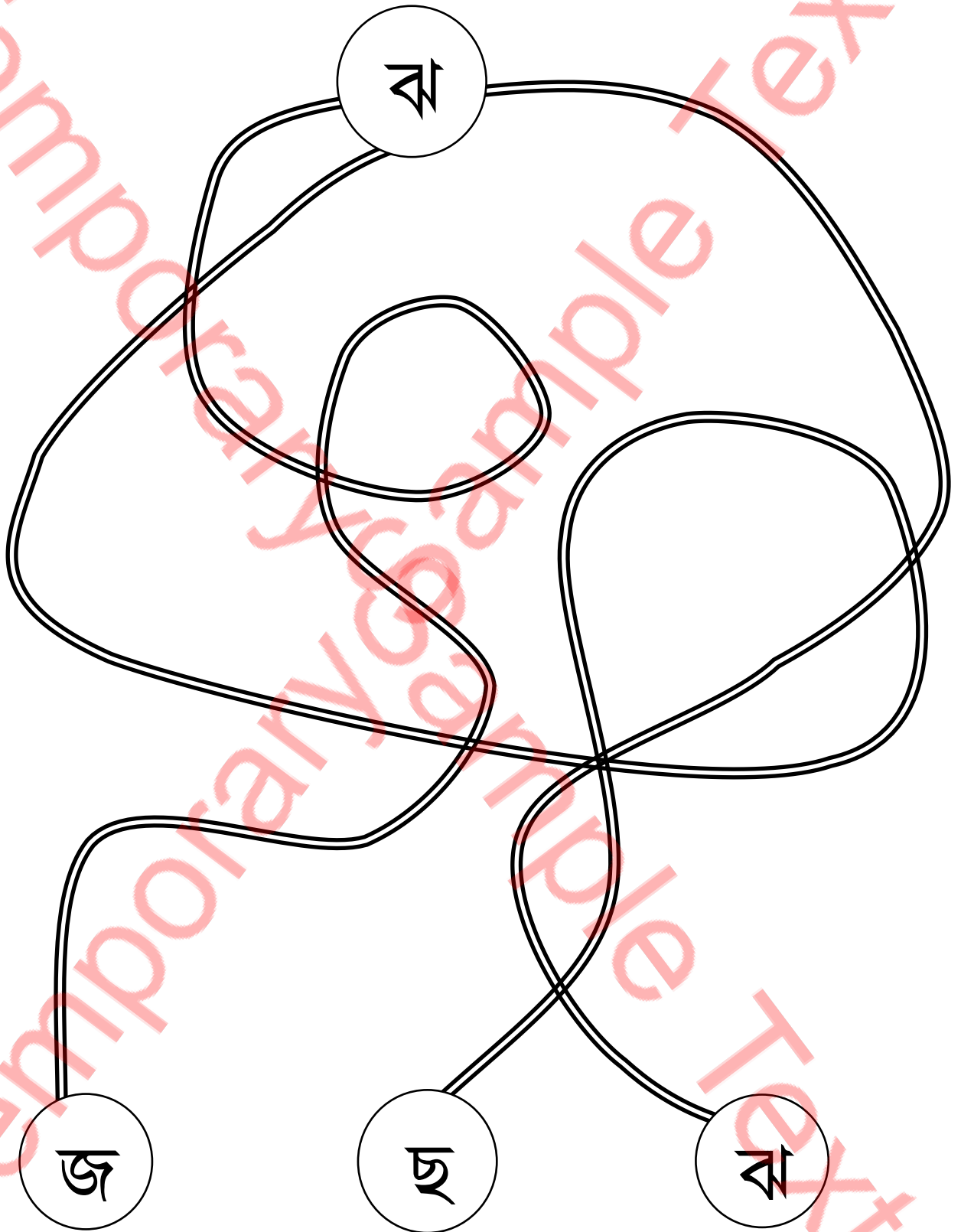

Student Name: \_\_\_\_\_

Verified By: \_\_\_\_\_

Class: \_\_\_\_\_

Date: \_\_\_\_\_



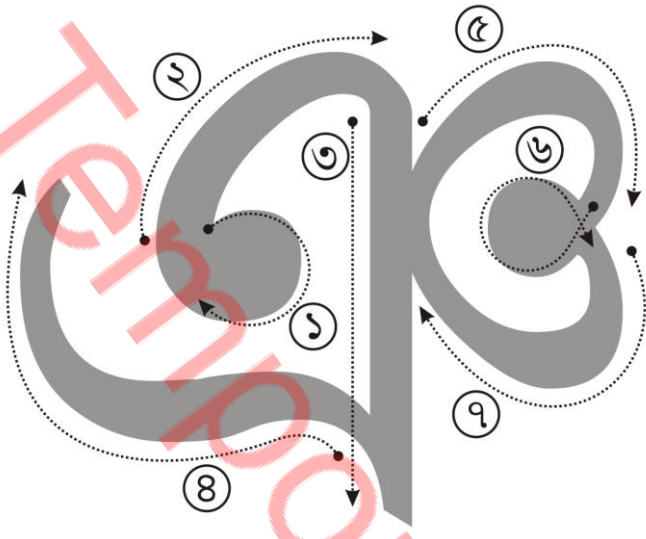

Follow the above steps



Colour it accordingly

ক	খ	গ	ঘ	ঙ	চ	ছ	জ
ঝ	ঞ	ট	ঠ	ড	ঢ	ণ	ত
থ	দ	ধ	ন	প	ফ	ব	ভ
ম	য	র	ল	শ	ষ	স	
হ	ক্ষ	জ	ড	য়	ং	ঃ	ঁ

Student Name: \_\_\_\_\_

Verified By: \_\_\_\_\_

Class: \_\_\_\_\_

Date: \_\_\_\_\_

## Trace It



Student Name: \_\_\_\_\_

Verified By: \_\_\_\_\_

Class: \_\_\_\_\_

Date: \_\_\_\_\_

## Trace it

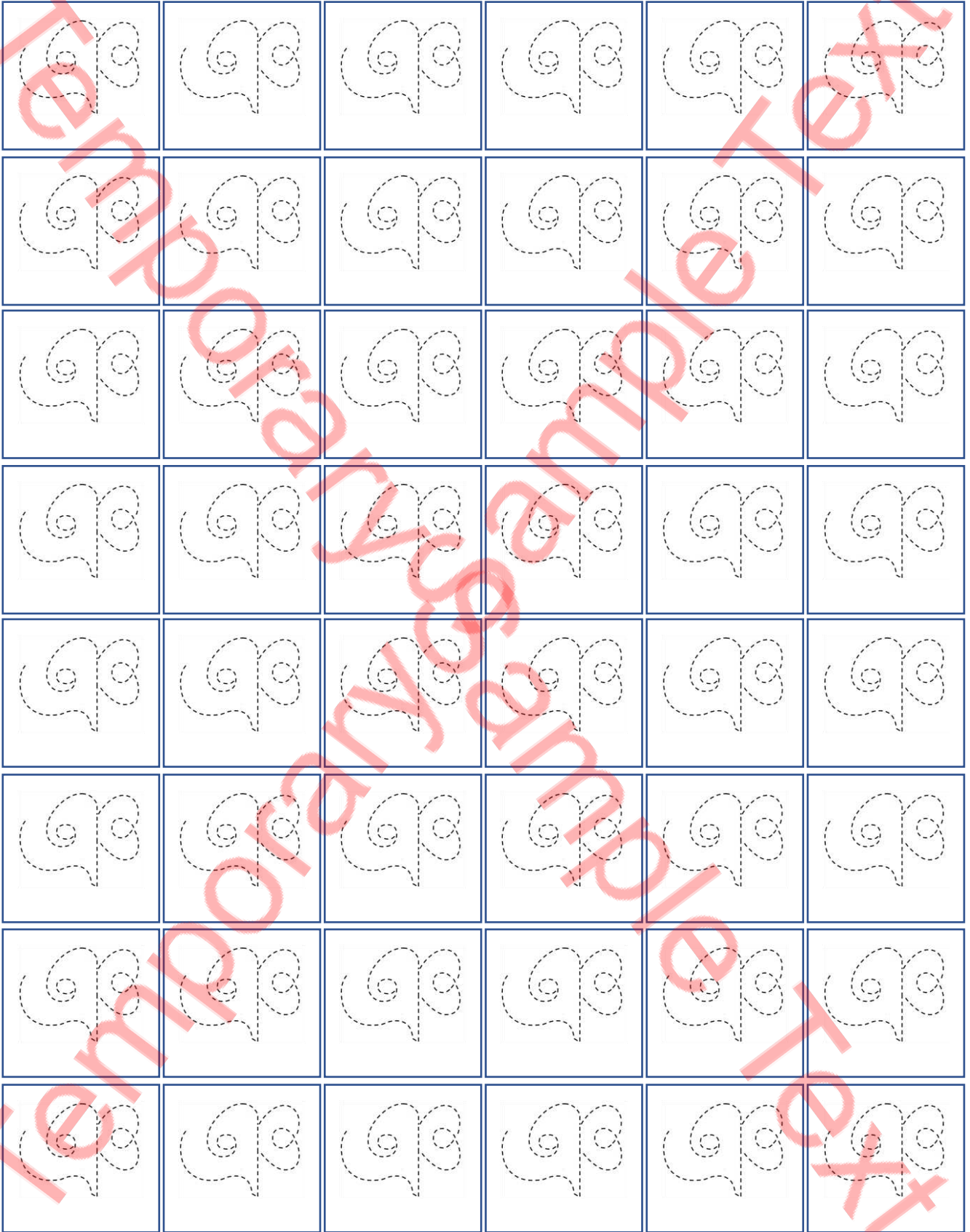

Student Name: \_\_\_\_\_

Verified By: \_\_\_\_\_

Class: \_\_\_\_\_

Date: \_\_\_\_\_

## Write it

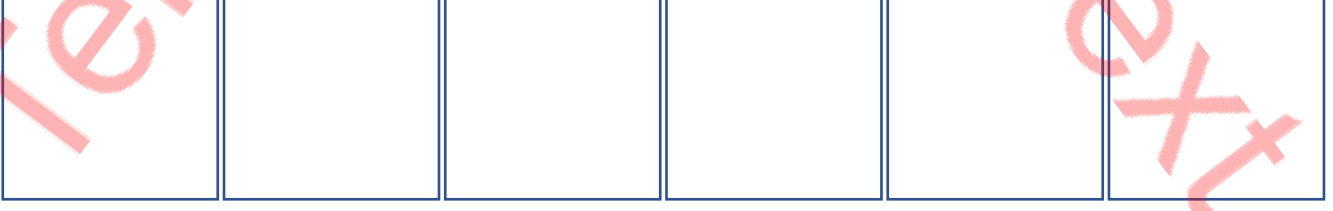
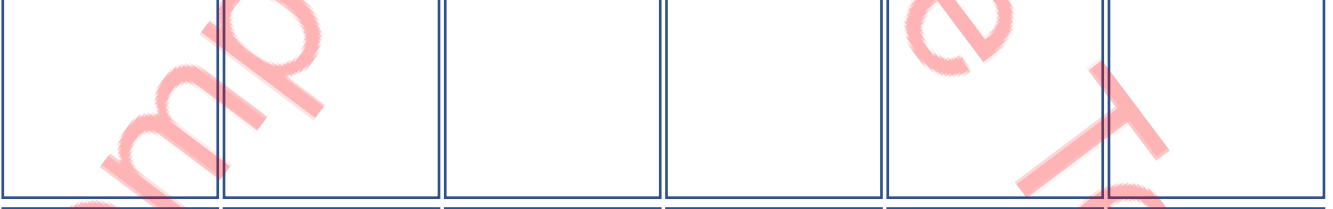
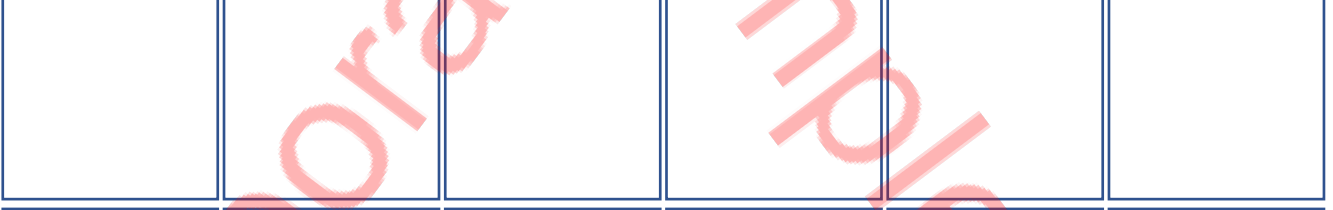
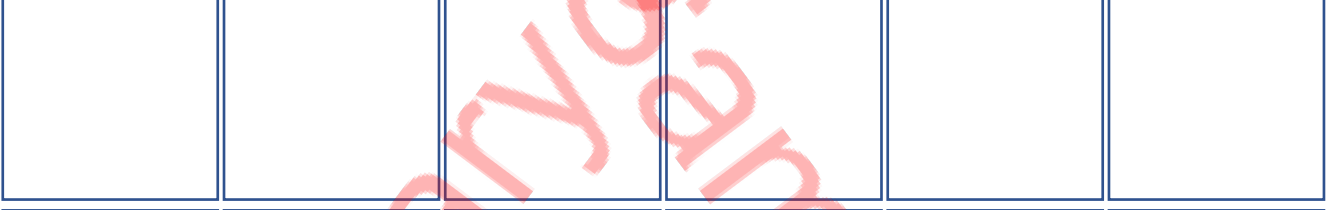
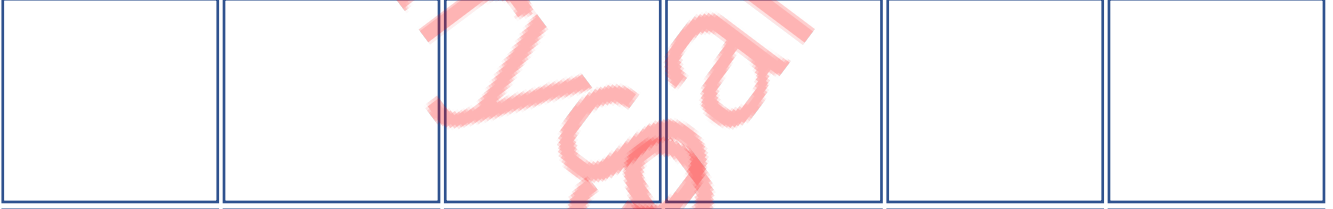
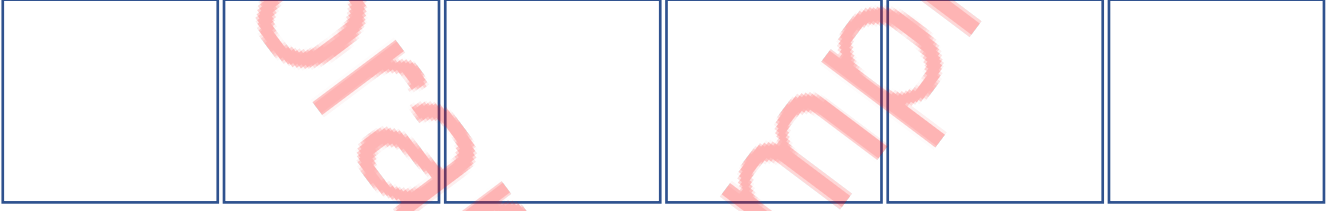
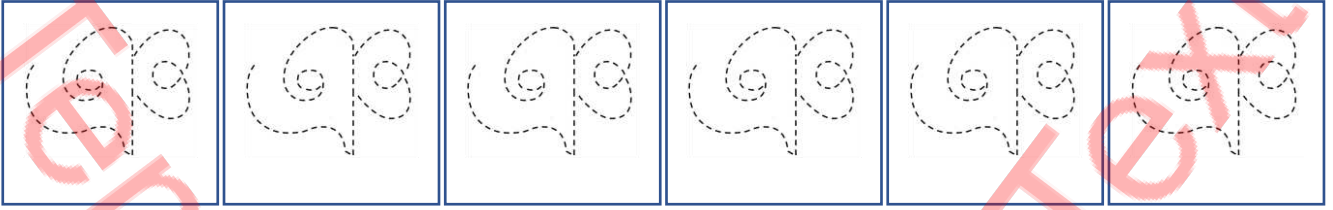

Student Name: \_\_\_\_\_

Verified By: \_\_\_\_\_

Class: \_\_\_\_\_

Date: \_\_\_\_\_

Copy Colour

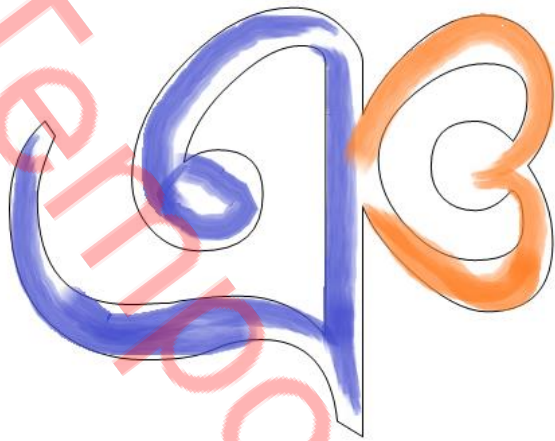

Colour it



Write it

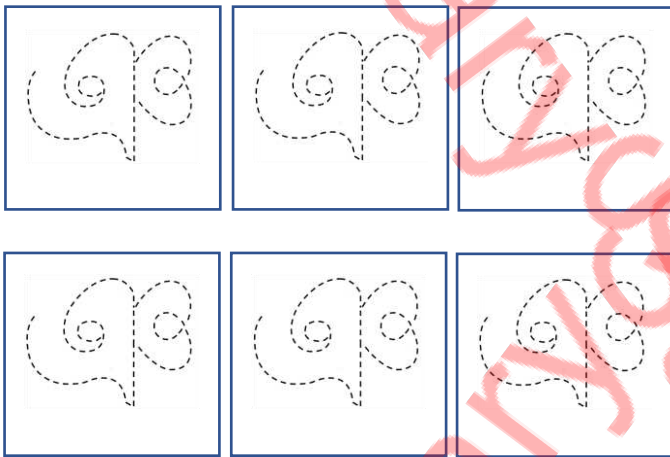

Find it



Connect the circle

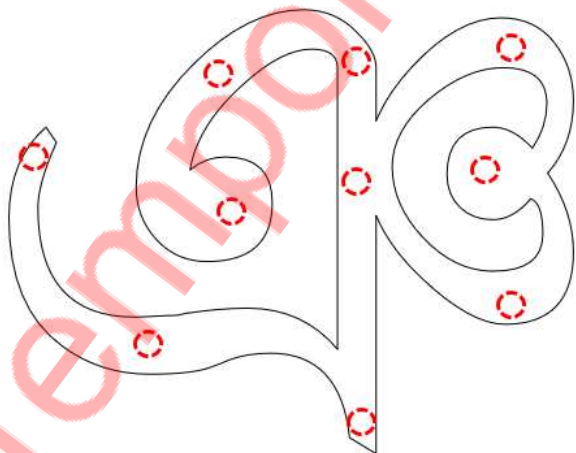

Do it

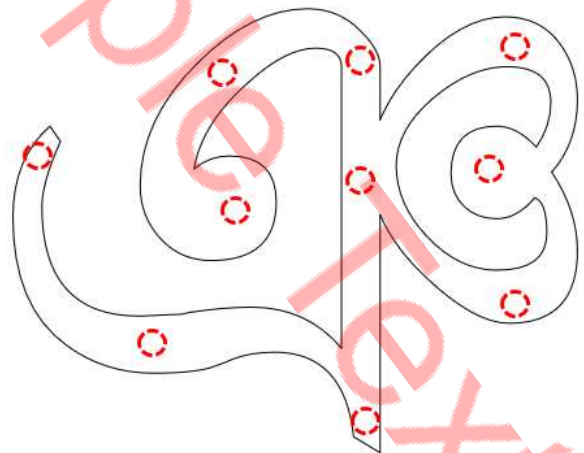

Student Name: \_\_\_\_\_

Verified By: \_\_\_\_\_

Class: \_\_\_\_\_

Date: \_\_\_\_\_



# Pick the Path Find the Correct Alphabet

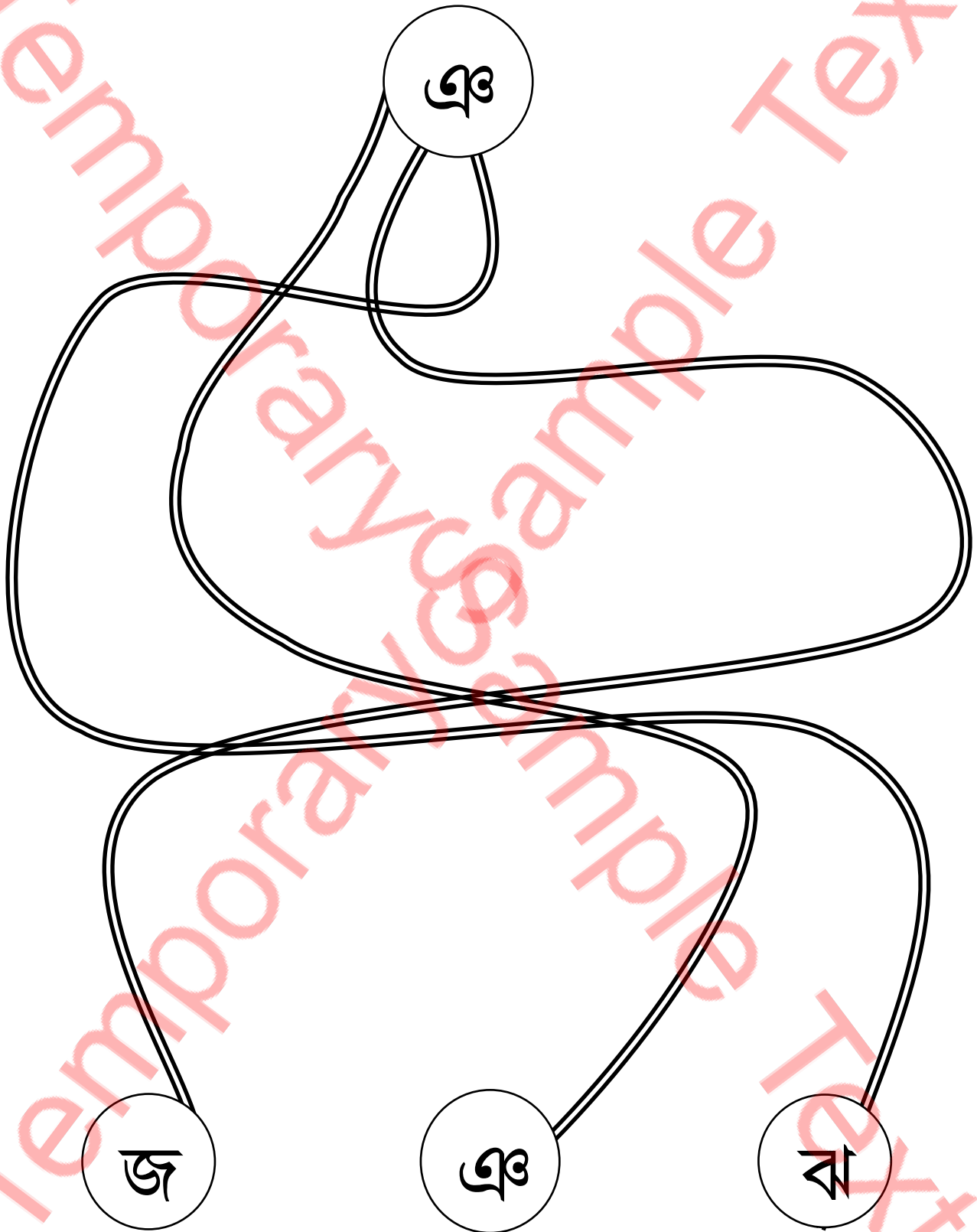

Student Name: \_\_\_\_\_

Verified By: \_\_\_\_\_

Class: \_\_\_\_\_

Date: \_\_\_\_\_



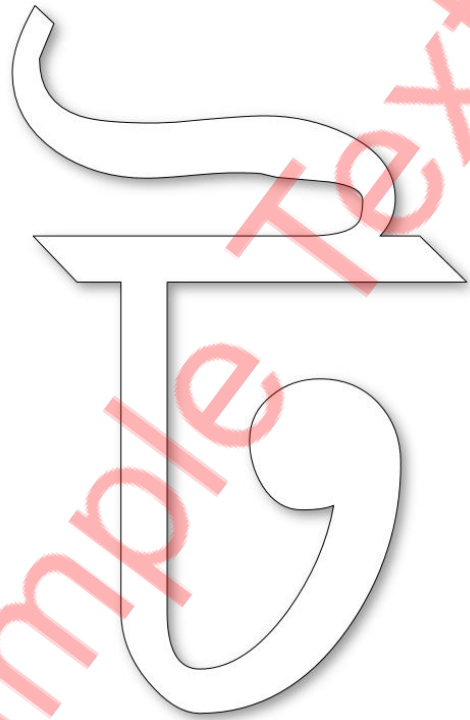
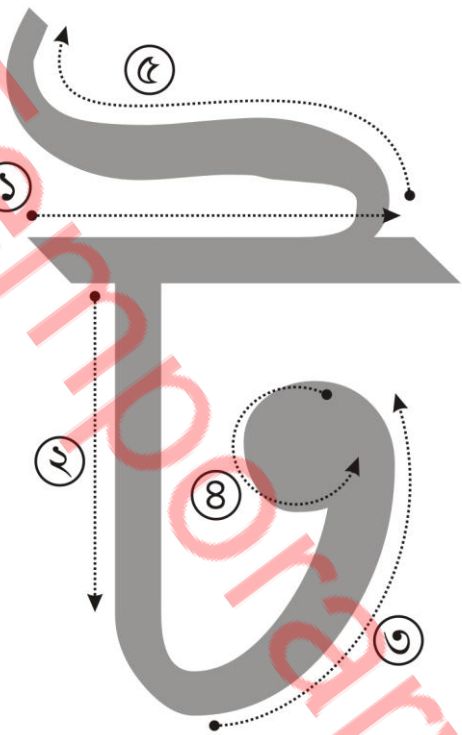

Follow the above steps

Colour it accordingly

ক	খ	গ	ঘ	ঙ	চ	ছ	জ
ঝ	ঞ	ট	ঠ	ড	ঢ	ণ	ত
থ	দ	ধ	ন	প	ফ	ব	ভ
ম	য	র	ল	শ	ষ	স	
হ	ক্ষ	ড়	ঢ়	য়	ং	ঃ	ঁ

Student Name: \_\_\_\_\_

Verified By: \_\_\_\_\_

Class: \_\_\_\_\_

Date: \_\_\_\_\_

## Trace It



Student Name: \_\_\_\_\_

Verified By: \_\_\_\_\_

Class: \_\_\_\_\_

Date: \_\_\_\_\_

## Trace it



Student Name: \_\_\_\_\_

Verified By: \_\_\_\_\_

Class: \_\_\_\_\_

Date: \_\_\_\_\_

Write it

ॐ	ॐ	ॐ	ॐ	ॐ	ॐ

Student Name: \_\_\_\_\_

Verified By: \_\_\_\_\_

Class: \_\_\_\_\_

Date: \_\_\_\_\_

Copy Colour



Colour it

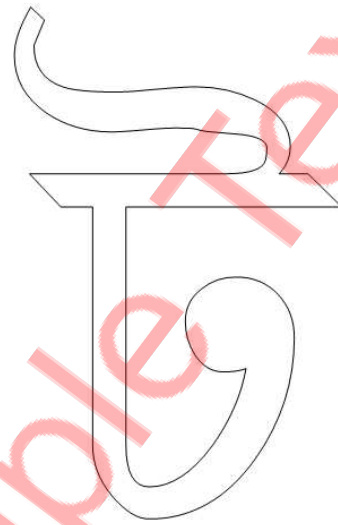

Write it

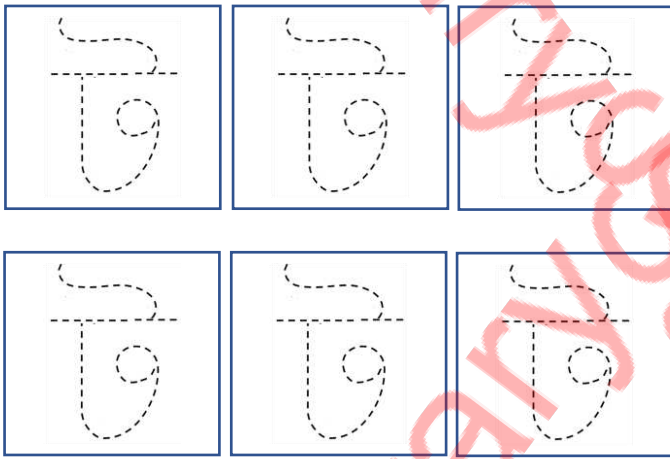

Find it

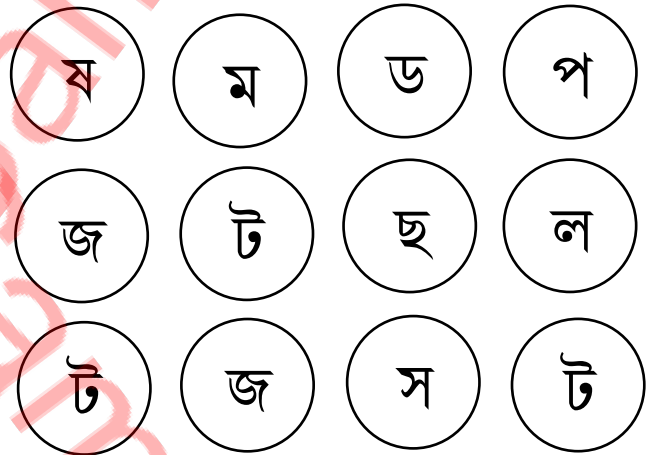

Connect the circle

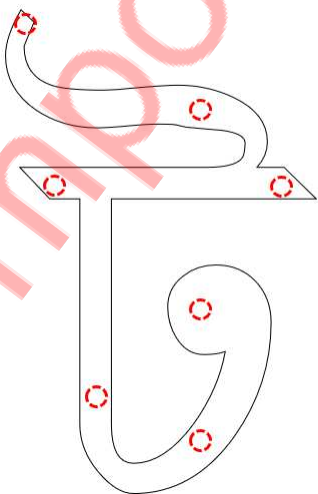

Do it

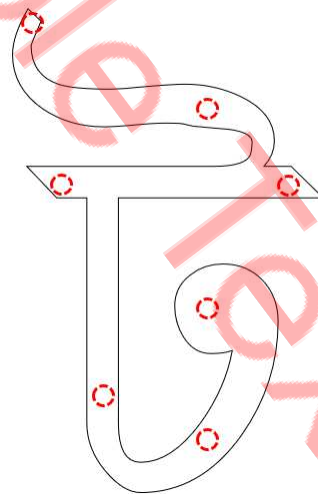

Student Name: \_\_\_\_\_

Verified By: \_\_\_\_\_

Class: \_\_\_\_\_

Date: \_\_\_\_\_

# Pick the Path Find the Correct Alphabet

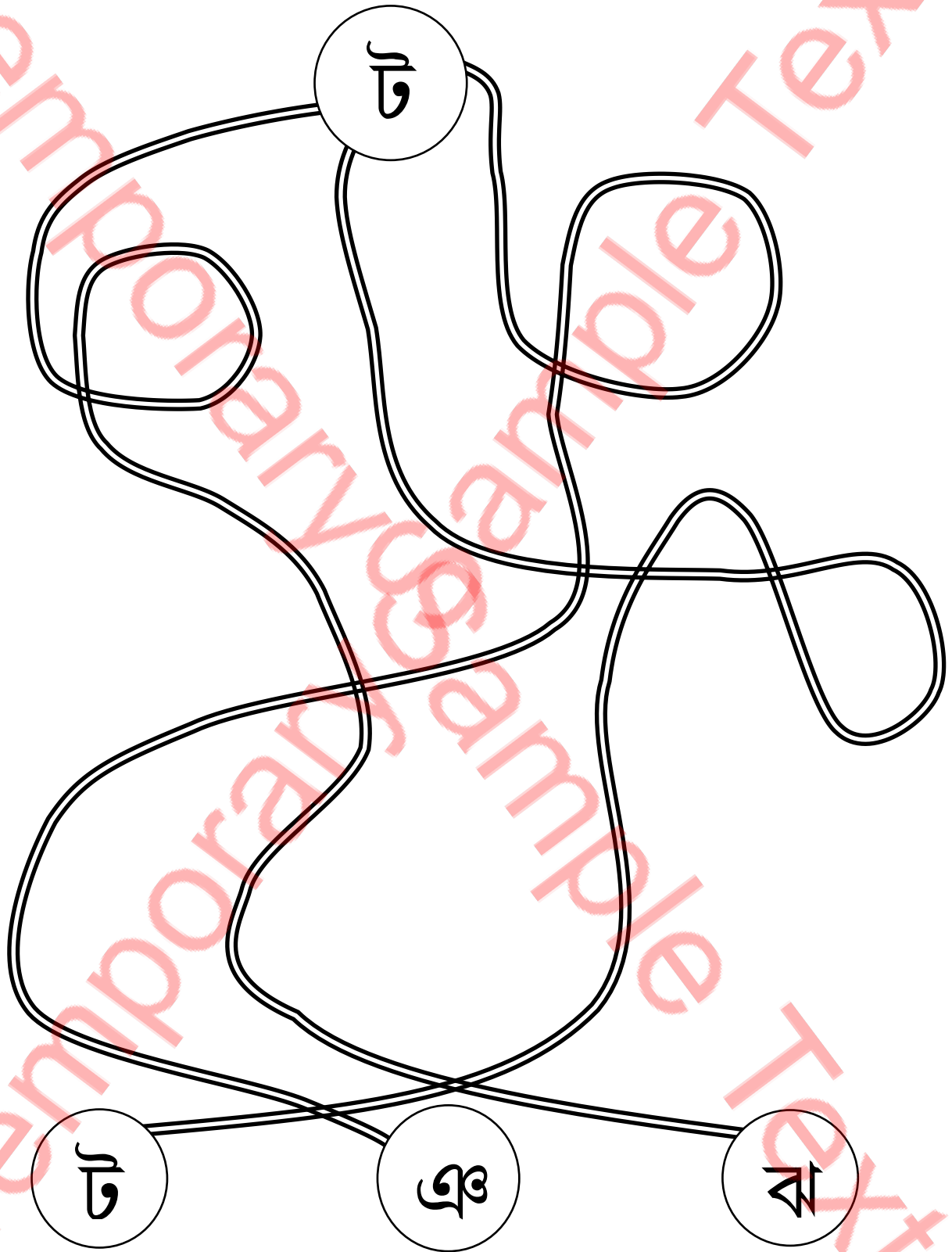

Student Name: \_\_\_\_\_

Verified By: \_\_\_\_\_

Class: \_\_\_\_\_

Date: \_\_\_\_\_



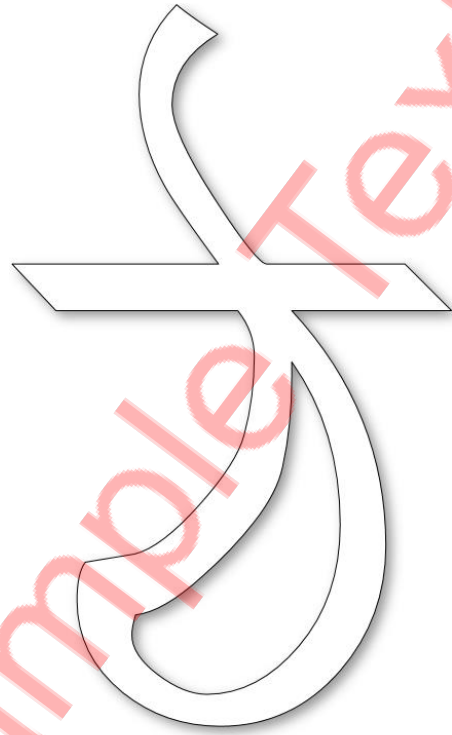
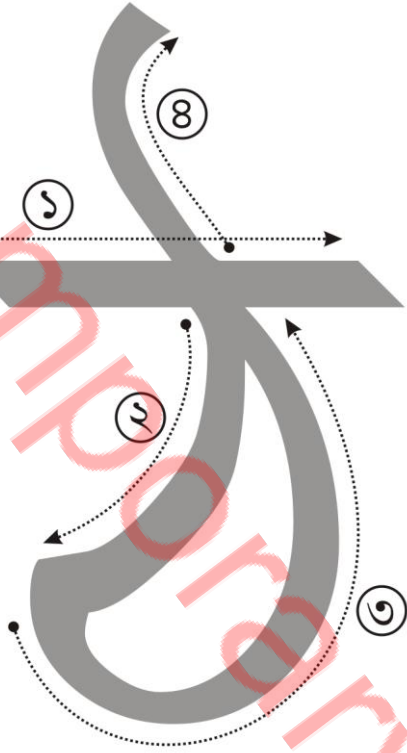

Follow the above steps

Colour it accordingly

ক	খ	গ	ঘ	ঙ	চ	ছ	জ
ঝ	ঞ	ট	ঠ	ড	ঢ	ণ	ত
থ	দ	ধ	ন	প	ফ	ব	ভ
ম	য	র	ল	শ	ষ	স	
ং	ক্ষ	জ্	ড্	য়	ৎ	ঙ	

Student Name: \_\_\_\_\_

Verified By: \_\_\_\_\_

Class: \_\_\_\_\_

Date: \_\_\_\_\_

## Trace It

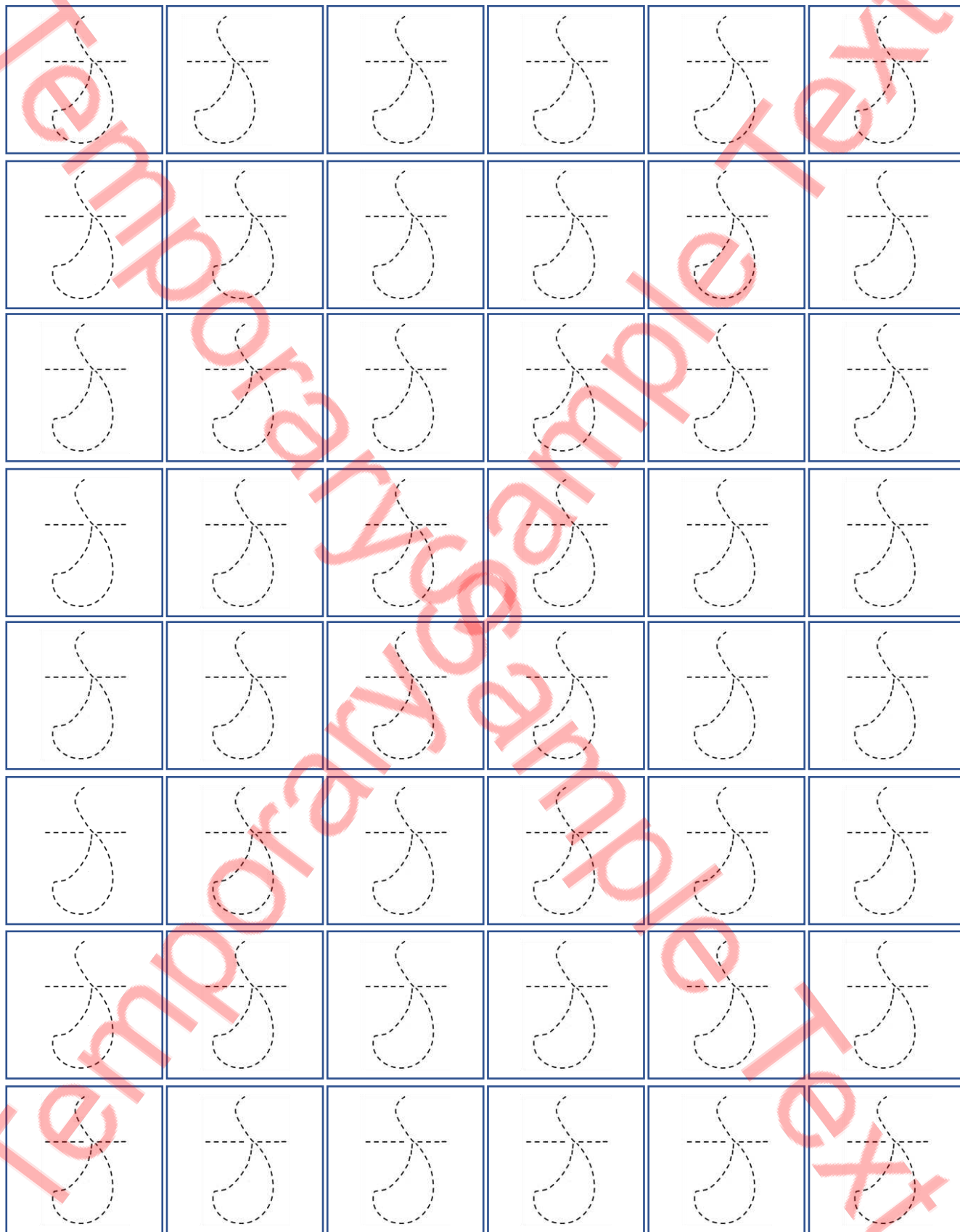

Student Name: \_\_\_\_\_

Verified By: \_\_\_\_\_

Class: \_\_\_\_\_

Date: \_\_\_\_\_

## Trace it

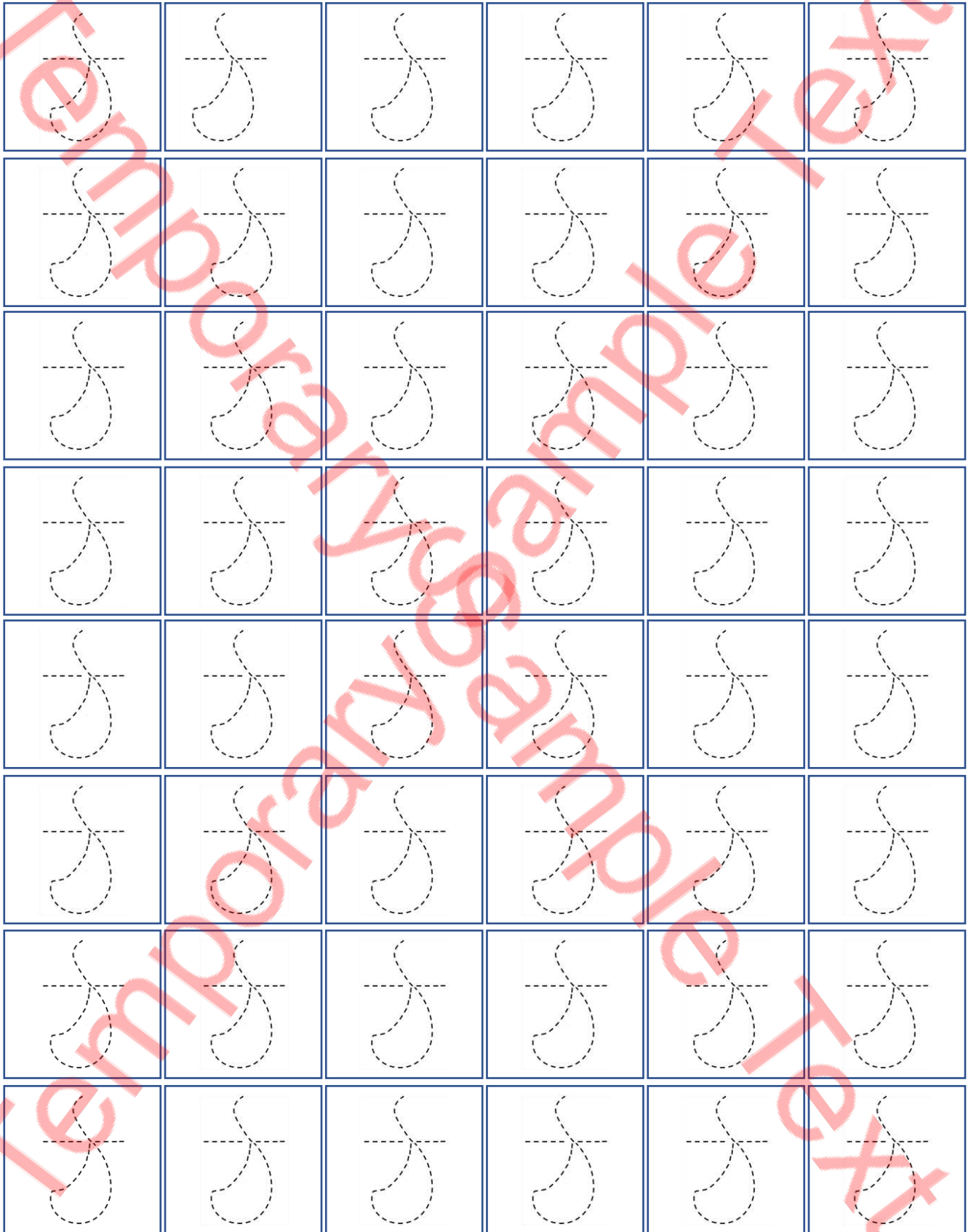

Student Name: \_\_\_\_\_

Verified By: \_\_\_\_\_

Class: \_\_\_\_\_

Date: \_\_\_\_\_

## Write it



Student Name: \_\_\_\_\_

Verified By: \_\_\_\_\_

Class: \_\_\_\_\_

Date: \_\_\_\_\_

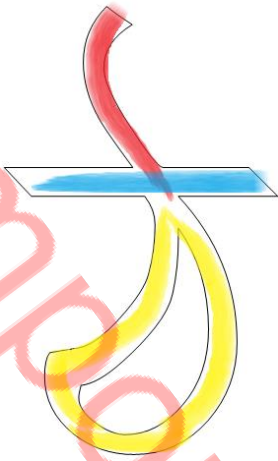
Copy Colour



Colour it

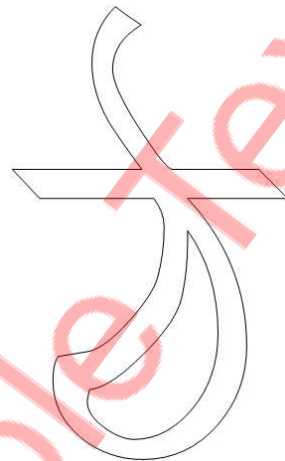

Write it

Find it

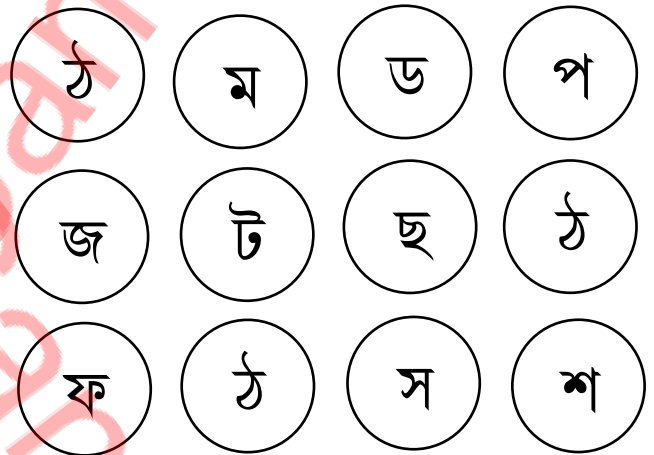
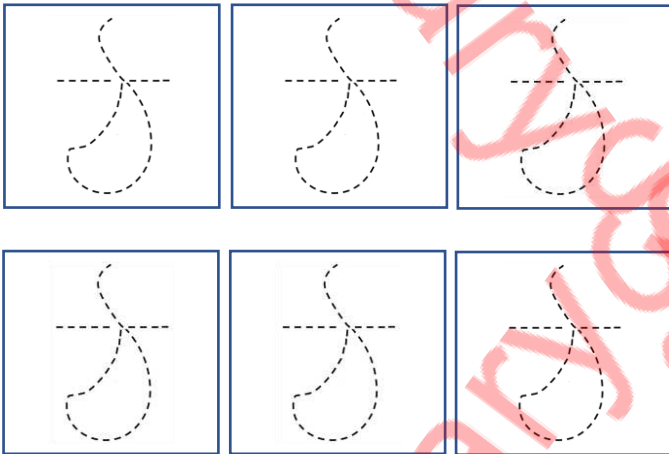

Connect the circle

Do it

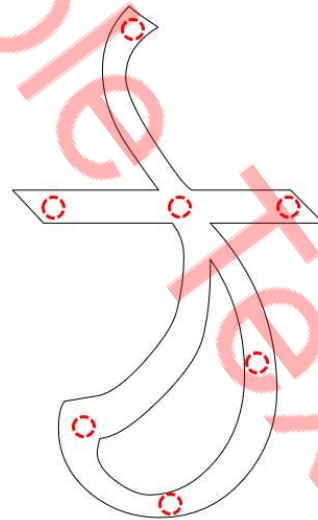
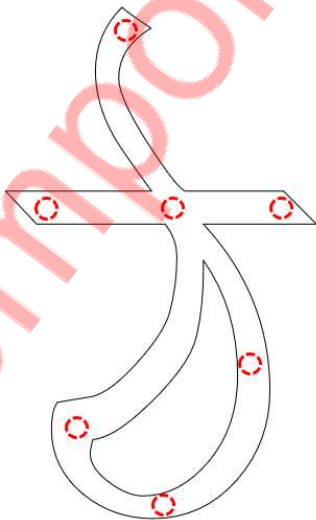

Student Name: \_\_\_\_\_

Verified By: \_\_\_\_\_

Class: \_\_\_\_\_

Date: \_\_\_\_\_

# Pick the Path Find the Correct Alphabet

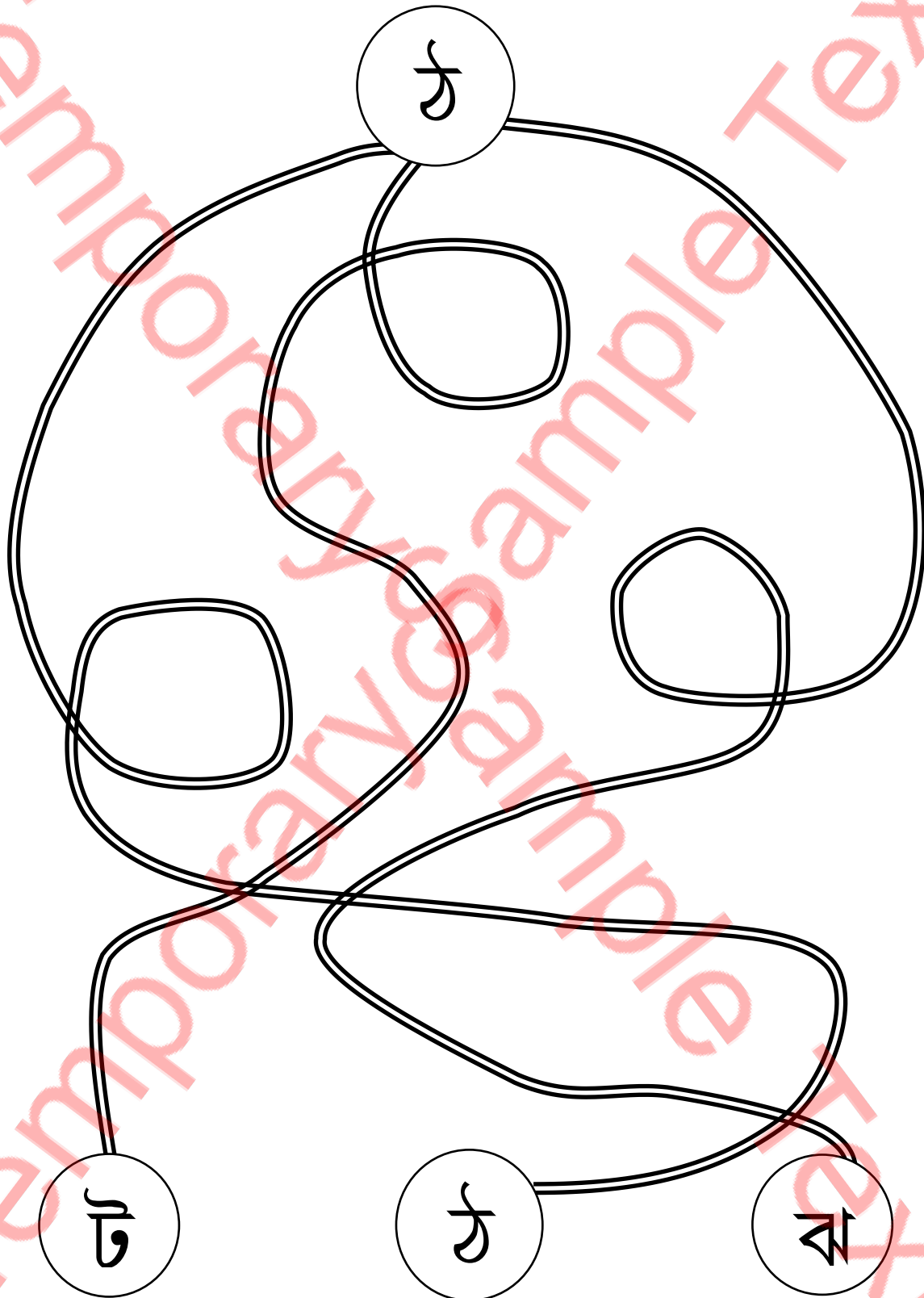

Student Name: \_\_\_\_\_

Verified By: \_\_\_\_\_

Class: \_\_\_\_\_

Date: \_\_\_\_\_



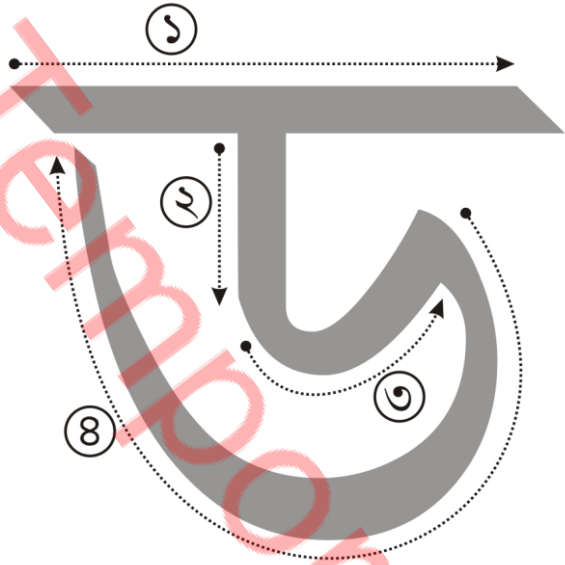

Follow the above steps

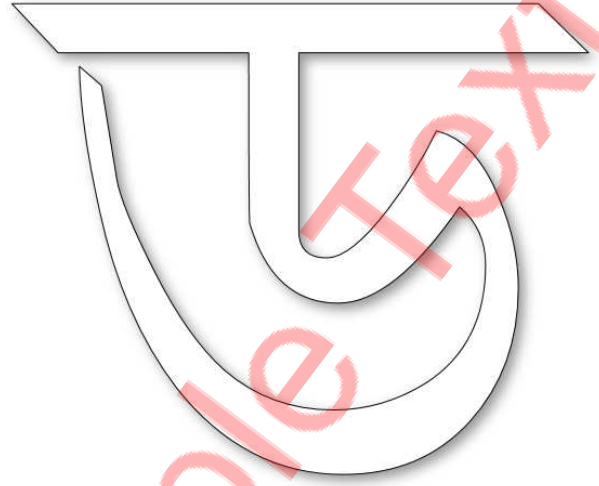

Colour it accordingly

ক	খ	গ	ঘ	ঙ	চ	ছ	জ
ঝ	ঞ	ট	ঠ	ড	ত	থ	দ
ধ	দ	ধ	ন	প	ফ	ব	ভ
ম	য	ষ	প্র	র	শ	ষ	স
হ	ক্ষ	ড	ড	য়	ং	ং	ং

Student Name: \_\_\_\_\_

Verified By: \_\_\_\_\_

Class: \_\_\_\_\_

Date: \_\_\_\_\_

# Trace It

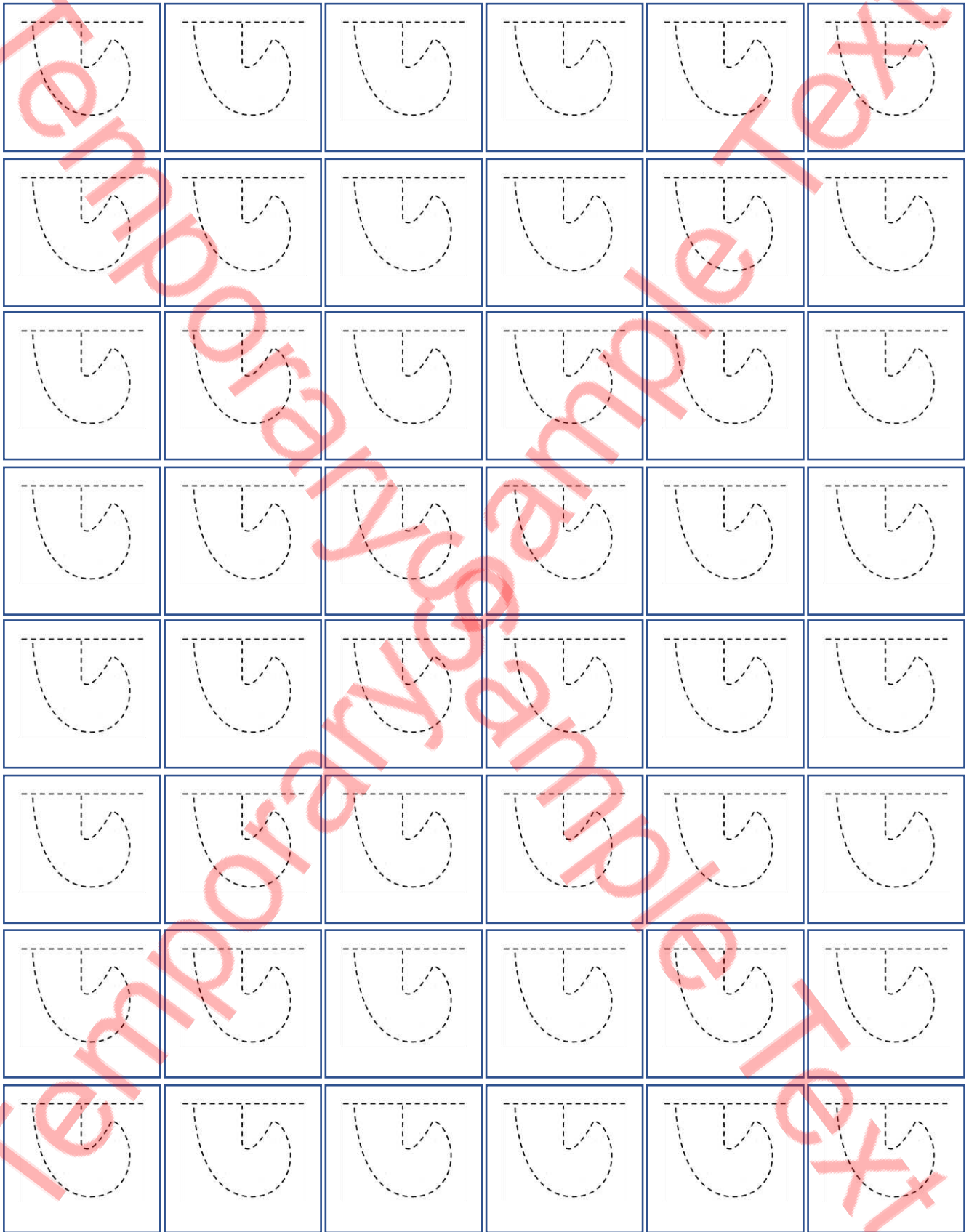

Student Name: \_\_\_\_\_

Verified By: \_\_\_\_\_

Class: \_\_\_\_\_

Date: \_\_\_\_\_

# Trace it

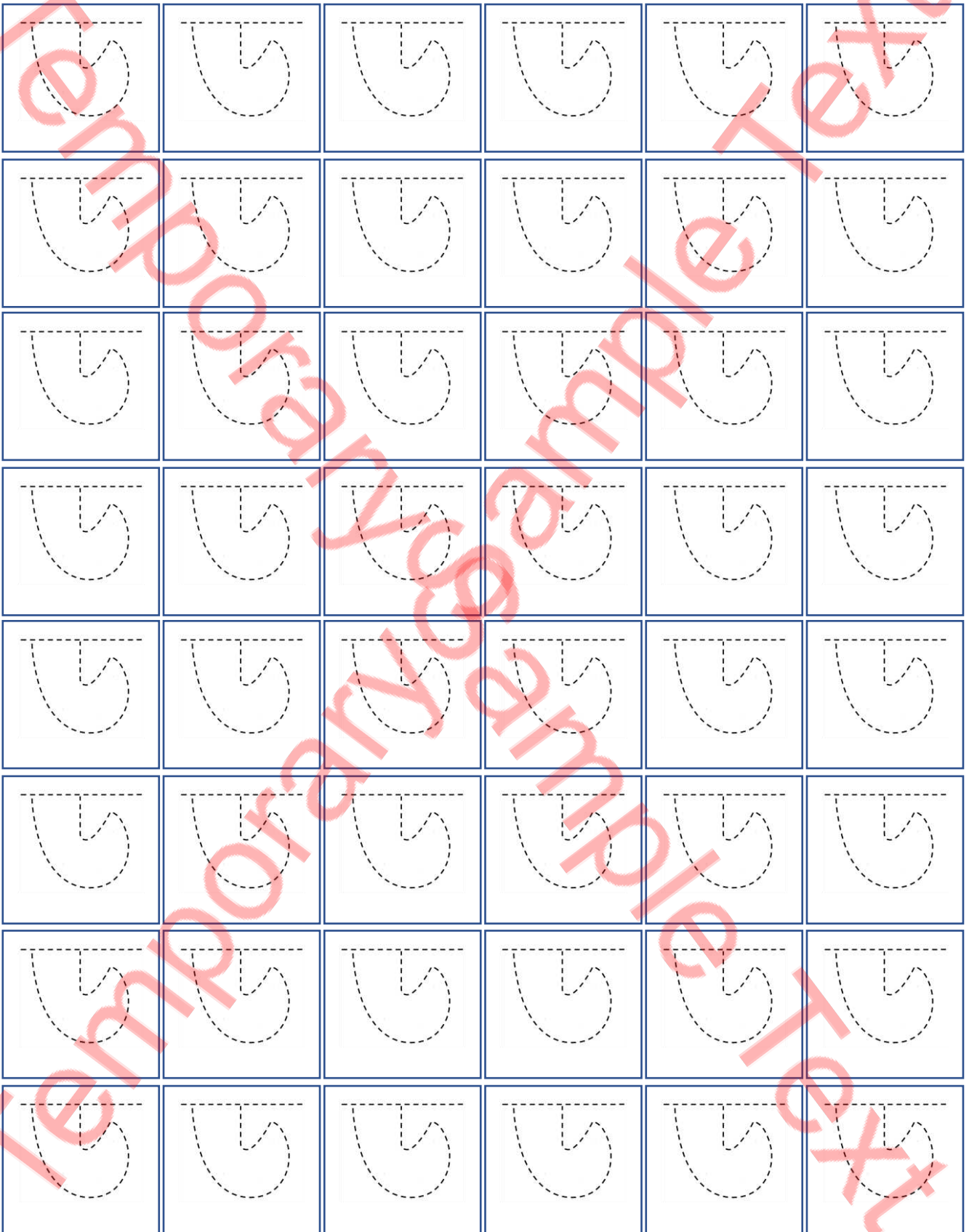

Student Name: \_\_\_\_\_

Verified By: \_\_\_\_\_

Class: \_\_\_\_\_

Date: \_\_\_\_\_

# Write it

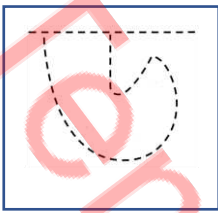
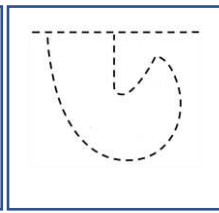
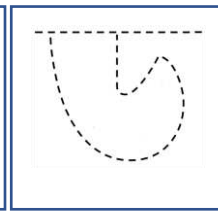
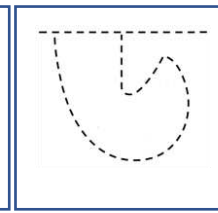
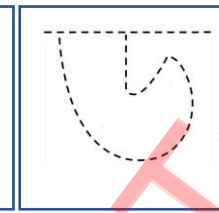
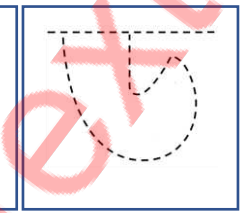
Student Name: \_\_\_\_\_

Verified By: \_\_\_\_\_

Class: \_\_\_\_\_

Date: \_\_\_\_\_

Copy Colour

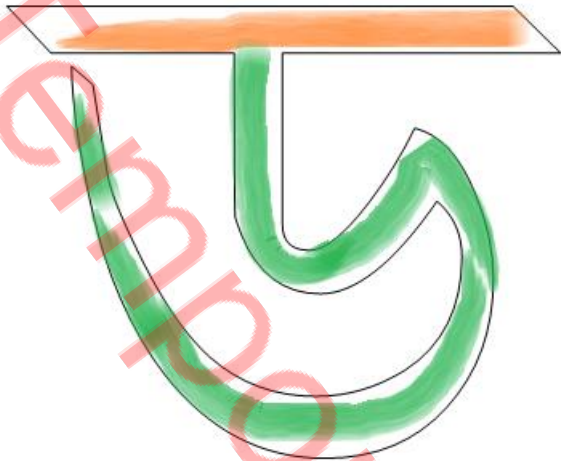

Colour it

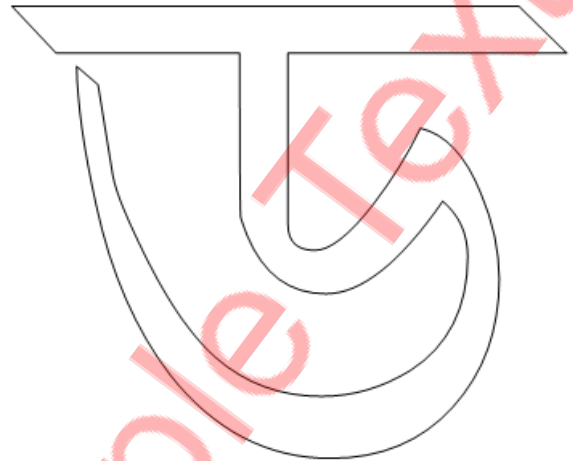

Write it

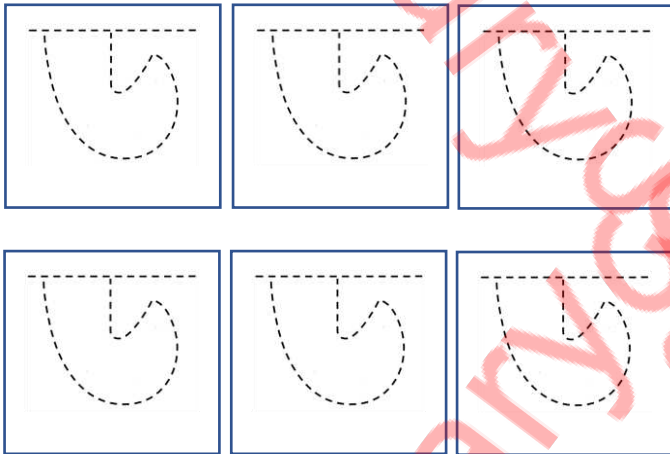

Find it

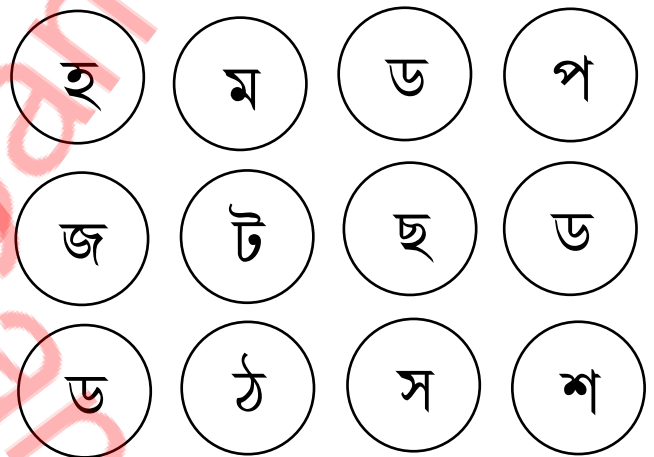

Connect the circle

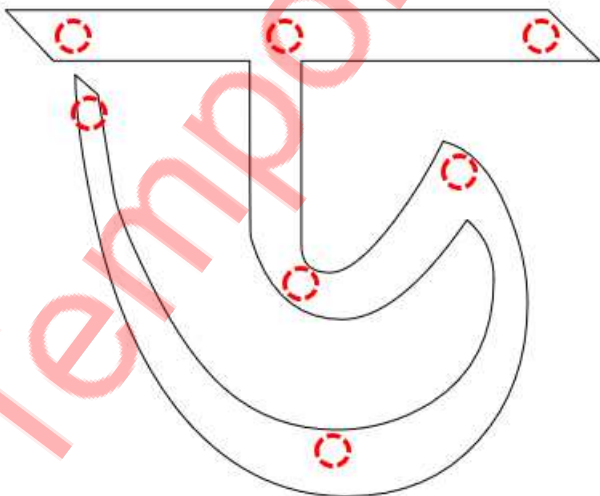

Do it

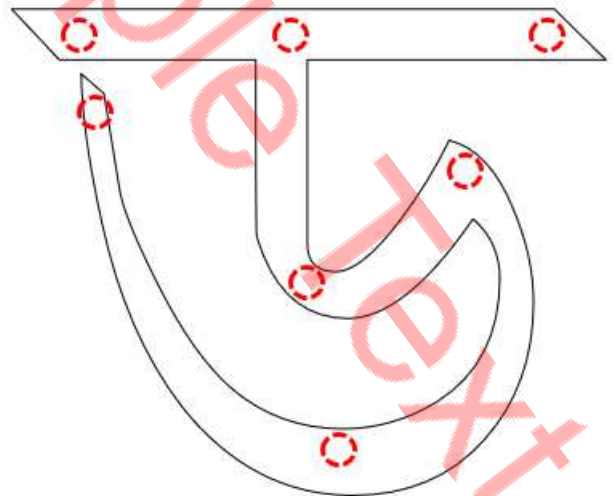

Student Name: \_\_\_\_\_

Verified By: \_\_\_\_\_

Class: \_\_\_\_\_

Date: \_\_\_\_\_

# Pick the Path Find the Correct Alphabet

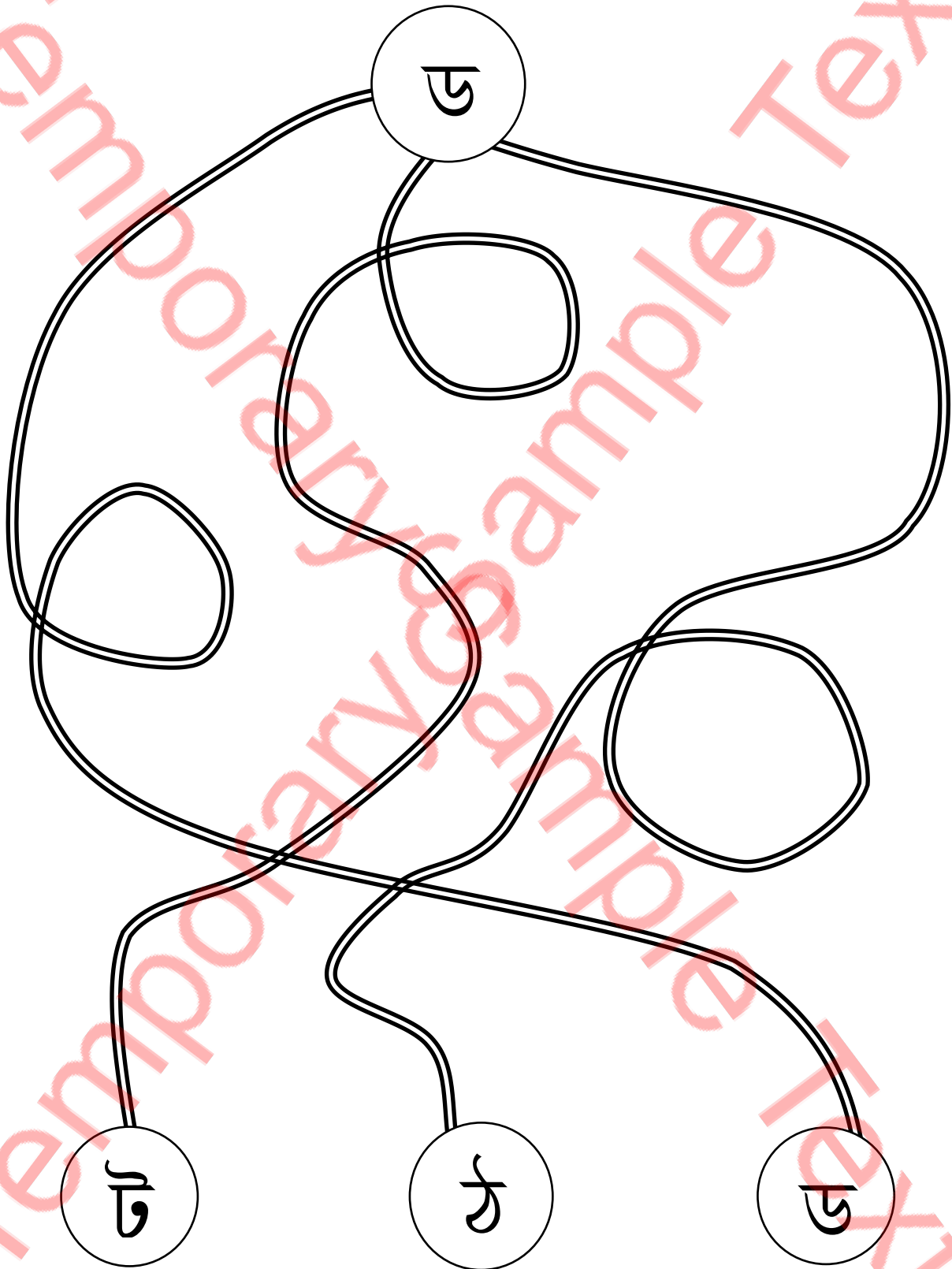

Student Name: \_\_\_\_\_

Verified By: \_\_\_\_\_

Class: \_\_\_\_\_

Date: \_\_\_\_\_



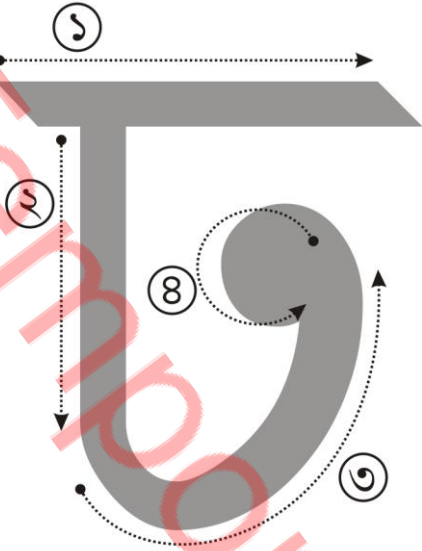

Follow the above steps

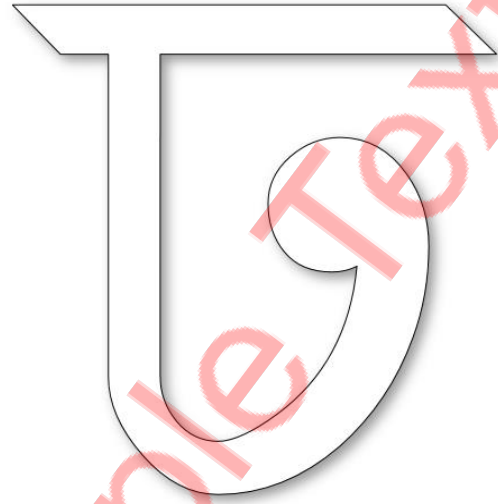

Colour it accordingly

ক	খ	গ	ঘ	ঙ	চ	ছ	জ
ঝ	ঞ	ট	ঠ	ড	ঢ	ণ	ত
থ	দ	ধ	ন	প	ফ	ব	ভ
ম	য	ষ	র	শ	ষ	ষ	স
হ	ক্ষ	ড়	ঢ়	য়	ং	ঃ	়

Student Name: \_\_\_\_\_

Verified By: \_\_\_\_\_

Class: \_\_\_\_\_

Date: \_\_\_\_\_

## Trace It

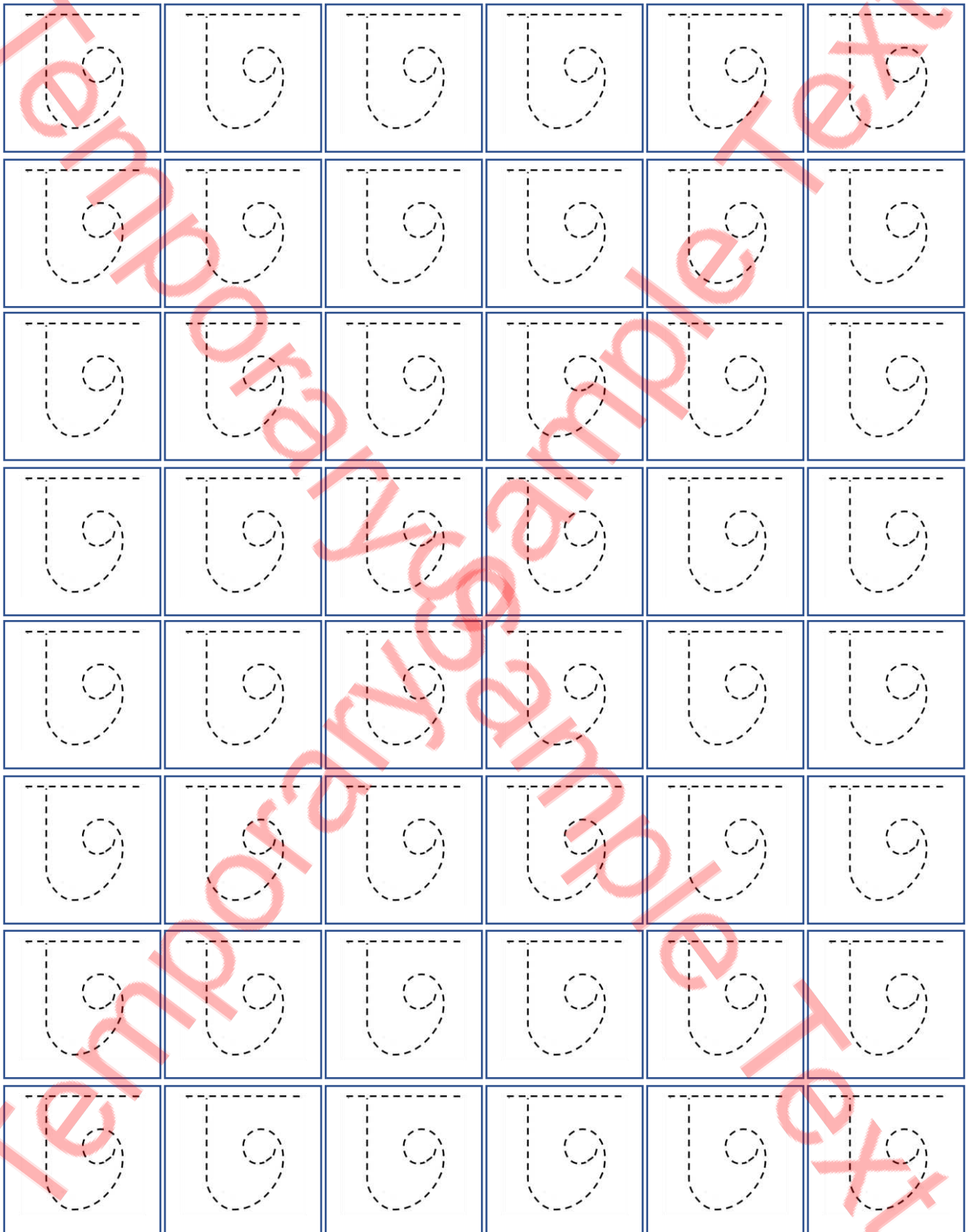

Student Name: \_\_\_\_\_

Verified By: \_\_\_\_\_

Class: \_\_\_\_\_

Date: \_\_\_\_\_

# Trace it



Student Name: \_\_\_\_\_

Verified By: \_\_\_\_\_

Class: \_\_\_\_\_

Date: \_\_\_\_\_

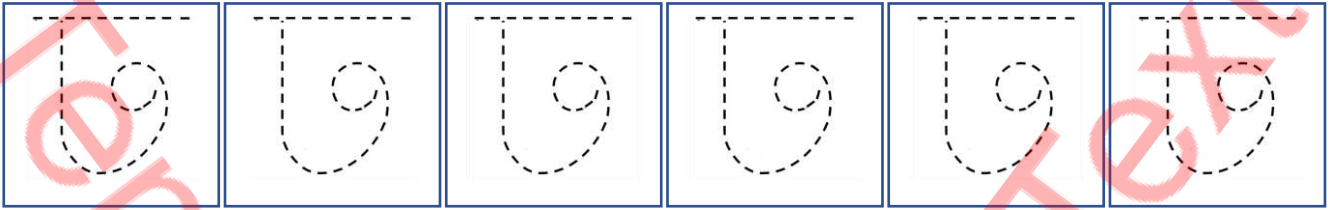
Write it



Student Name: \_\_\_\_\_

Verified By: \_\_\_\_\_

Class: \_\_\_\_\_

Date: \_\_\_\_\_

Copy Colour



Colour it

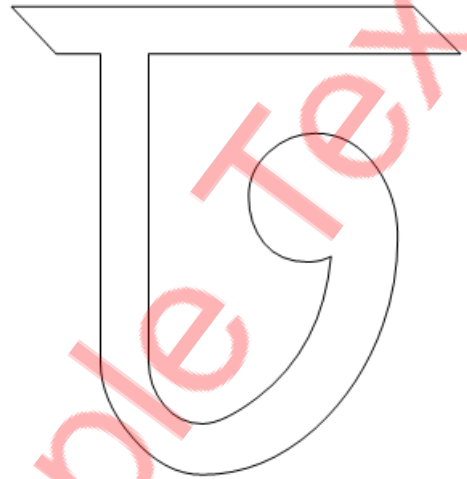

Write it

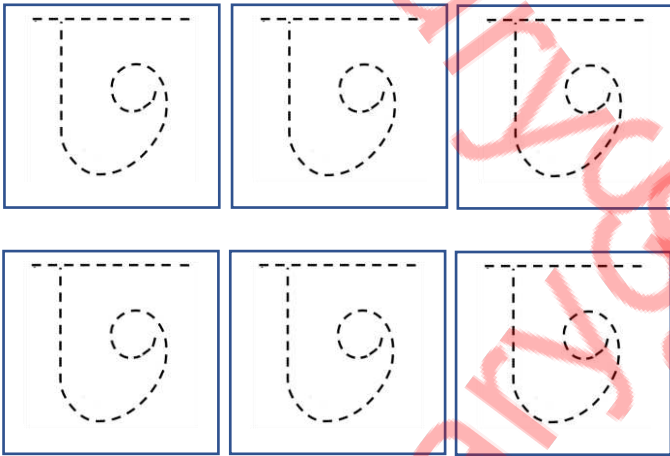

Find it

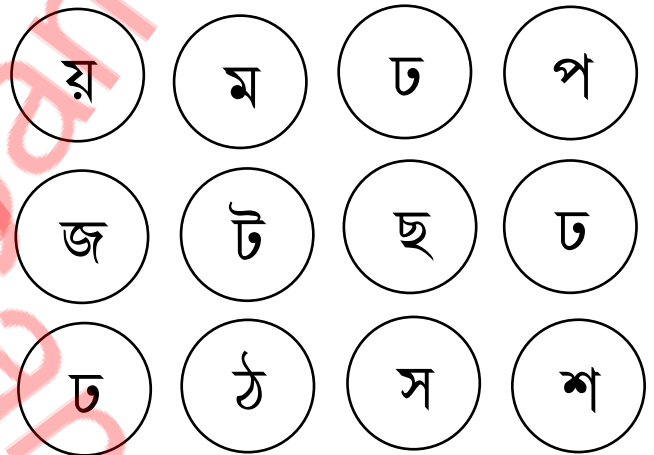

Connect the circle

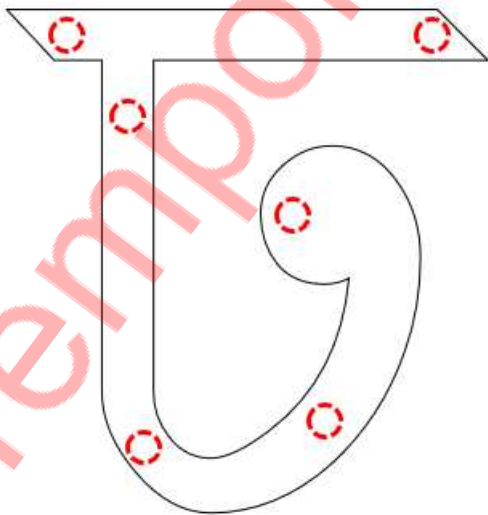

Do it

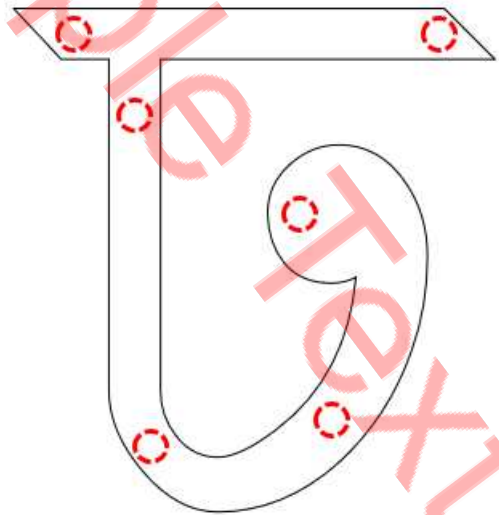

Student Name: \_\_\_\_\_

Verified By: \_\_\_\_\_

Class: \_\_\_\_\_

Date: \_\_\_\_\_

# Pick the Path Find the Correct Alphabet

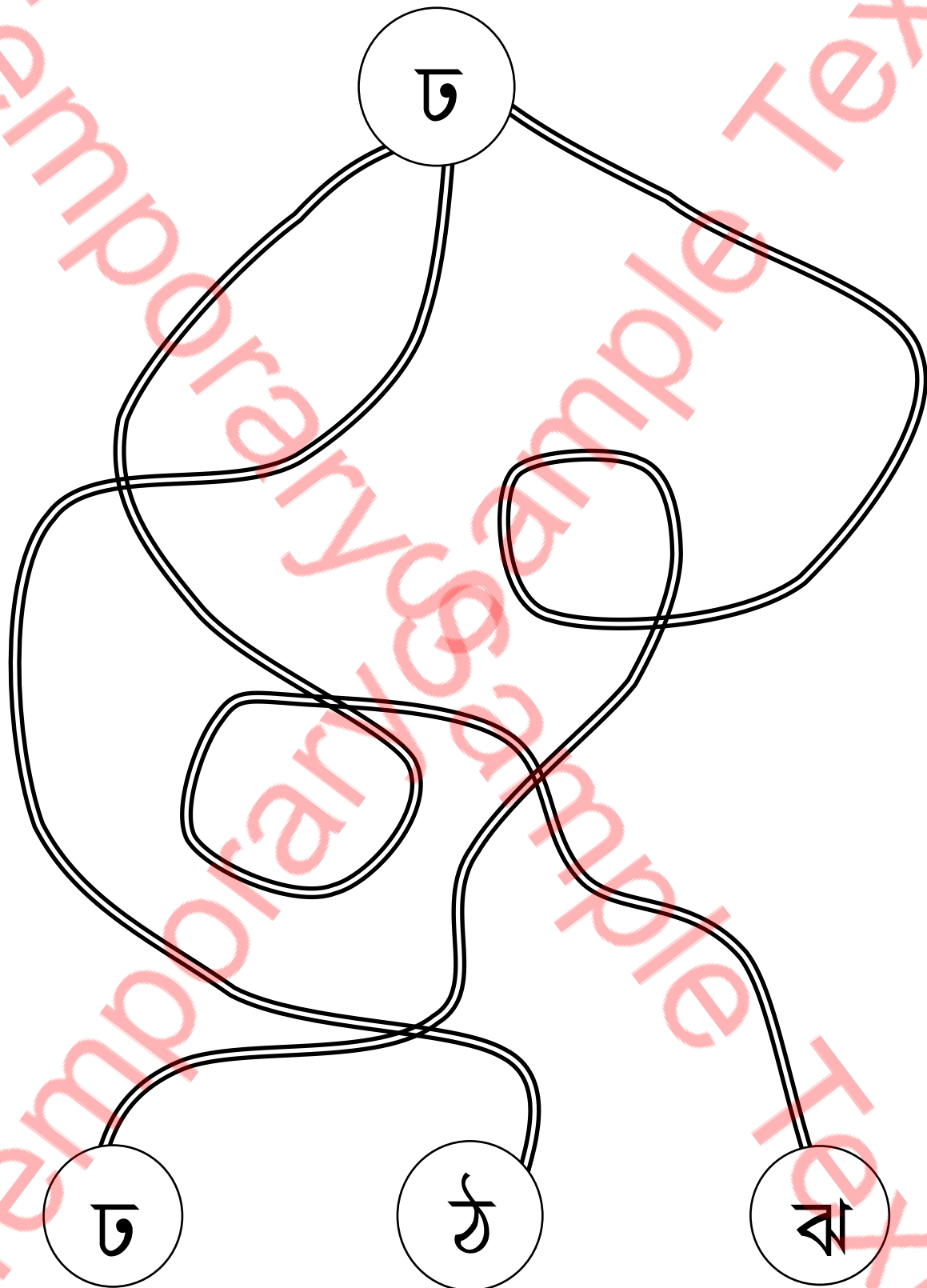

Student Name: \_\_\_\_\_

Verified By: \_\_\_\_\_

Class: \_\_\_\_\_

Date: \_\_\_\_\_



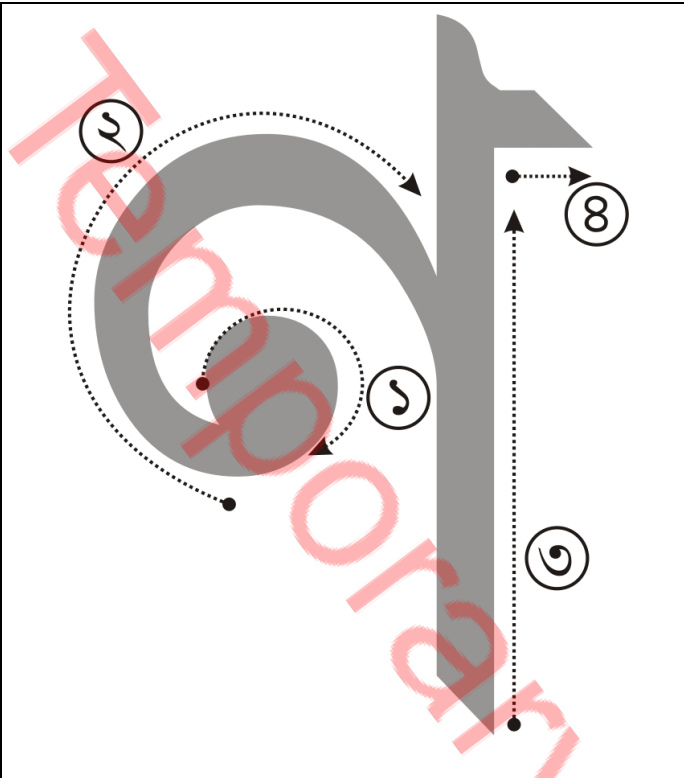

Follow the above steps

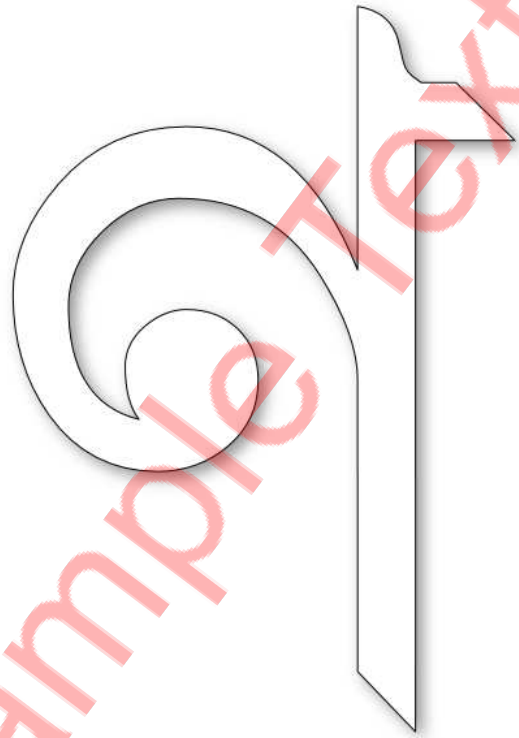

Colour it accordingly

ক	খ	গ	ঘ	ঙ	চ	ছ	জ
ঝ	ঞ	ট	ঠ	ড	ঢ	ণ	ত
থ	দ	ধ	ন	প	ফ	ব	ভ
ম	য	ষ	র	শ	ষ	স	
ং	ক্ষ	ড়	ঢ়	য়	়	ং	়

Student Name: \_\_\_\_\_

Verified By: \_\_\_\_\_

Class: \_\_\_\_\_

Date: \_\_\_\_\_

## Trace It

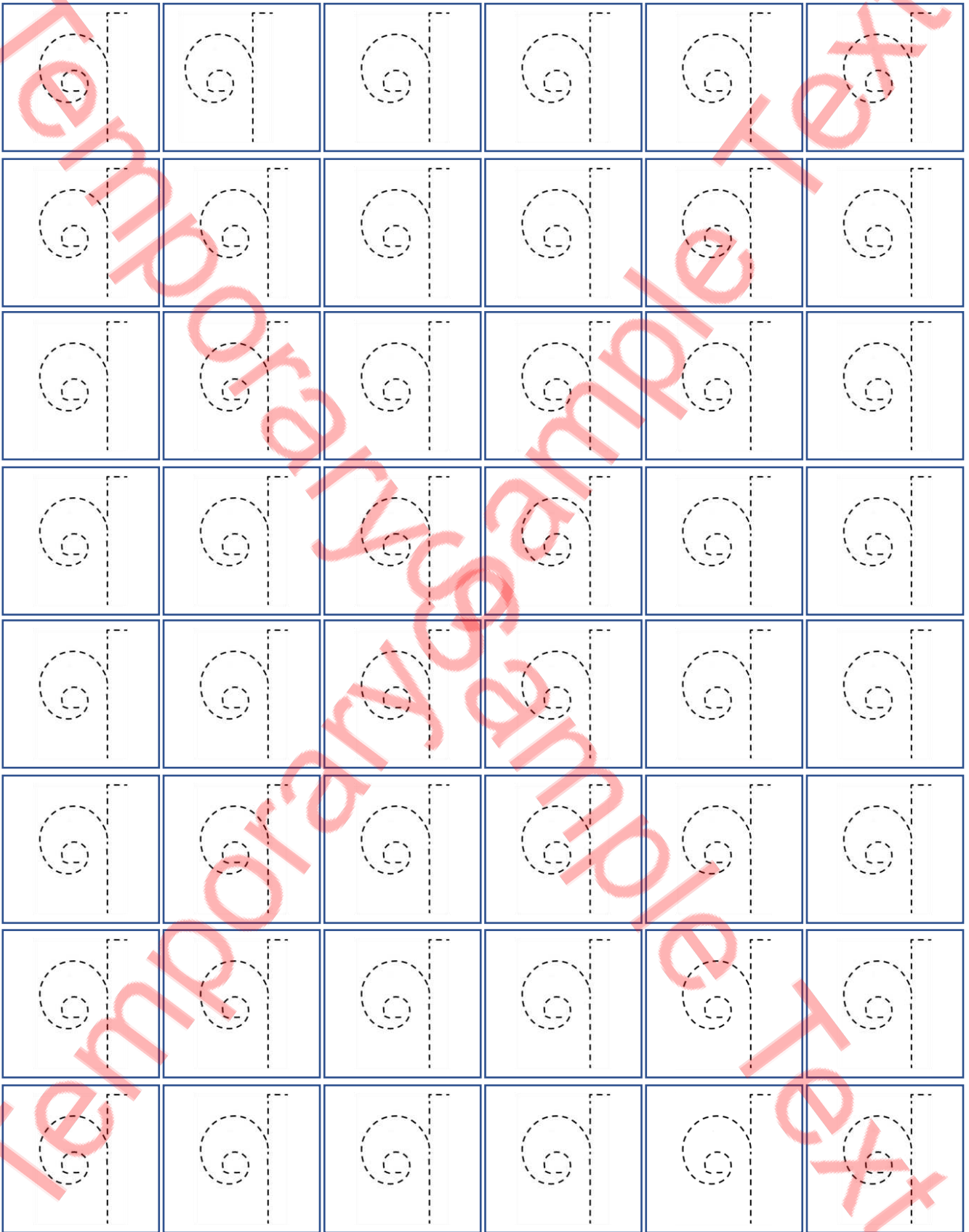

Student Name: \_\_\_\_\_

Verified By: \_\_\_\_\_

Class: \_\_\_\_\_

Date: \_\_\_\_\_

# Trace it



Student Name: \_\_\_\_\_

Verified By: \_\_\_\_\_

Class: \_\_\_\_\_

Date: \_\_\_\_\_

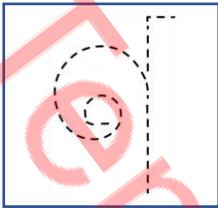
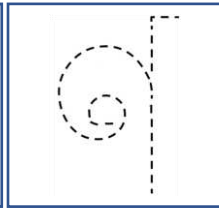
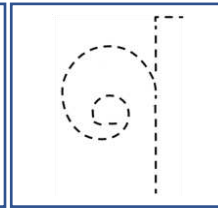
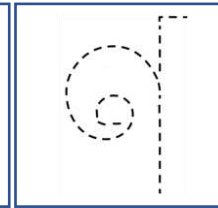
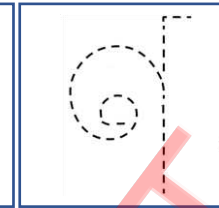
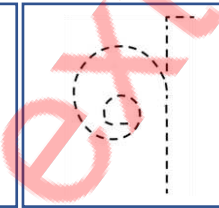
## Write it

Student Name: \_\_\_\_\_

Verified By: \_\_\_\_\_

Class: \_\_\_\_\_

Date: \_\_\_\_\_

Copy Colour

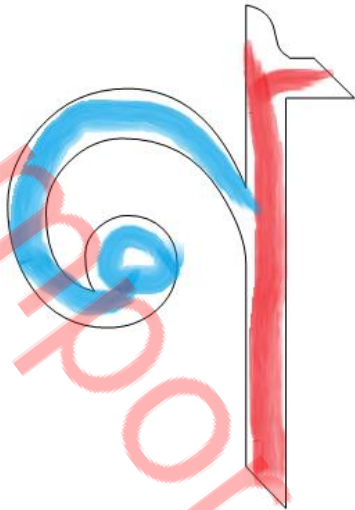

Colour it

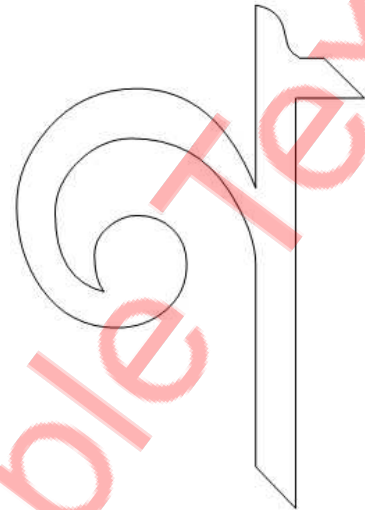

Write it

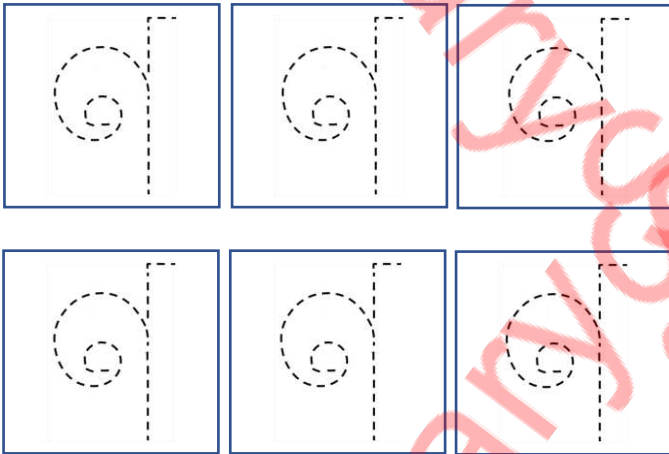

Find it

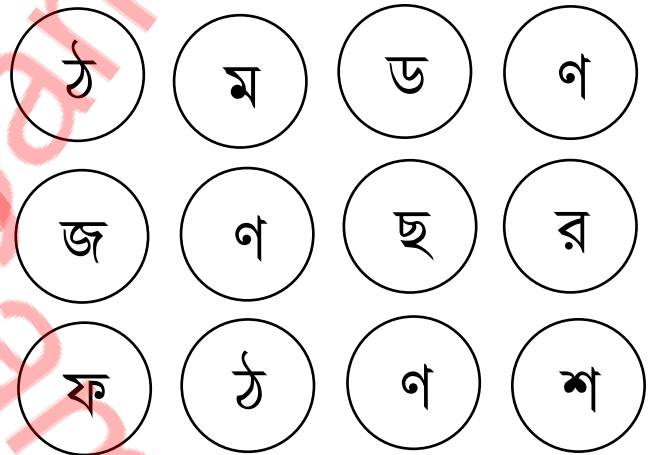

Connect the circle

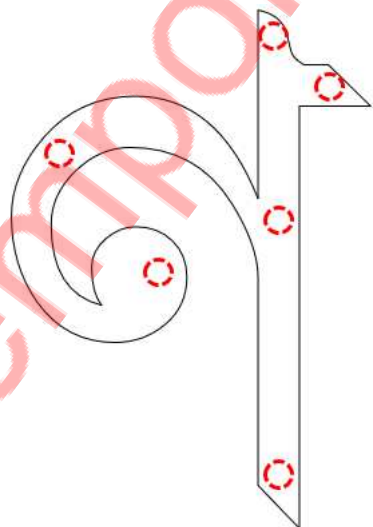

Do it

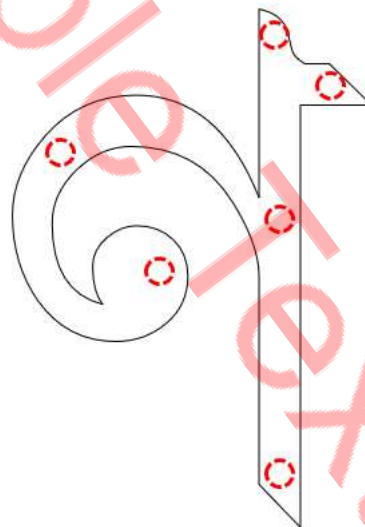

Student Name: \_\_\_\_\_

Verified By: \_\_\_\_\_

Class: \_\_\_\_\_

Date: \_\_\_\_\_

## Pick the Path Find the Correct Alphabet

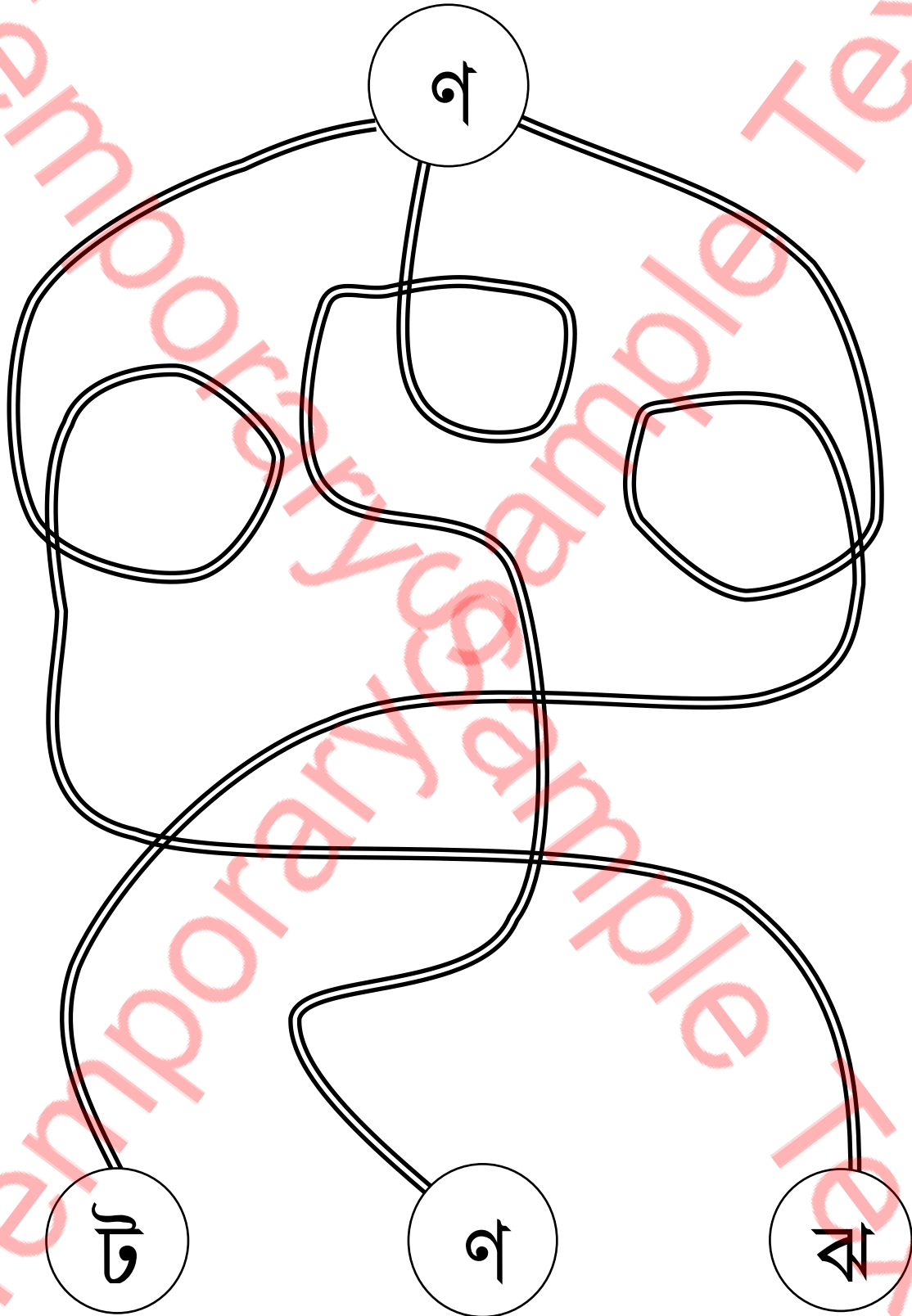

Student Name: \_\_\_\_\_

Verified By: \_\_\_\_\_

Class: \_\_\_\_\_

Date: \_\_\_\_\_



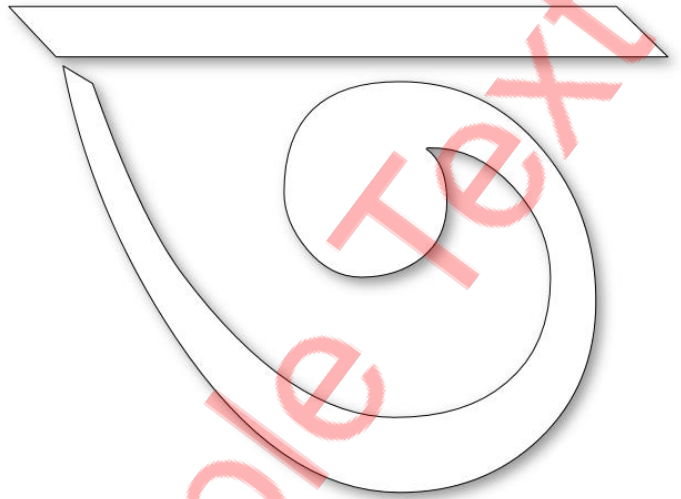
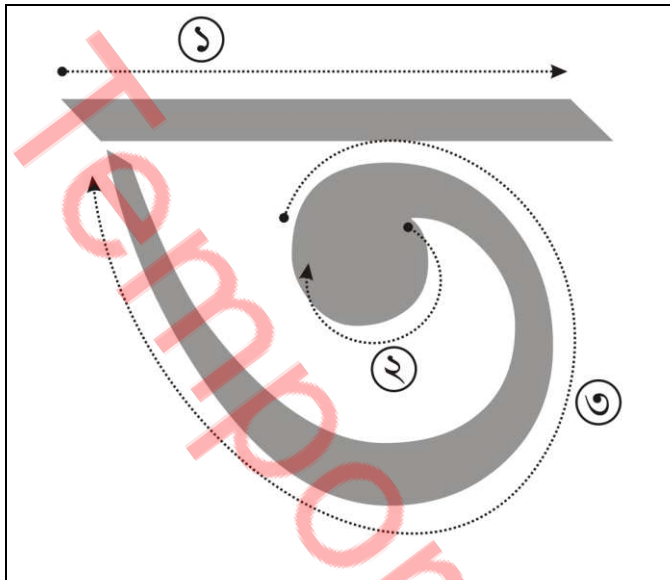

Follow the above steps

Colour it accordingly

ক	খ	গ	ঘ	ঙ	চ	ছ	জ
ঝ	ঞ	ট	ঠ	ড	ঢ	ণ	ত
থ	দ	ধ	ন	প	ফ	ব	ভ
ম	য	ষ	প্র	র	শ	ষ	স
হ	ক্ষ	ড়	ঢ়	য়	ং	ঃ	ঁ

Student Name: \_\_\_\_\_

Verified By: \_\_\_\_\_

Class: \_\_\_\_\_

Date: \_\_\_\_\_

## Trace It



Student Name: \_\_\_\_\_

Verified By: \_\_\_\_\_

Class: \_\_\_\_\_

Date: \_\_\_\_\_

# Trace it



Student Name: \_\_\_\_\_

Verified By: \_\_\_\_\_

Class: \_\_\_\_\_

Date: \_\_\_\_\_

Write it

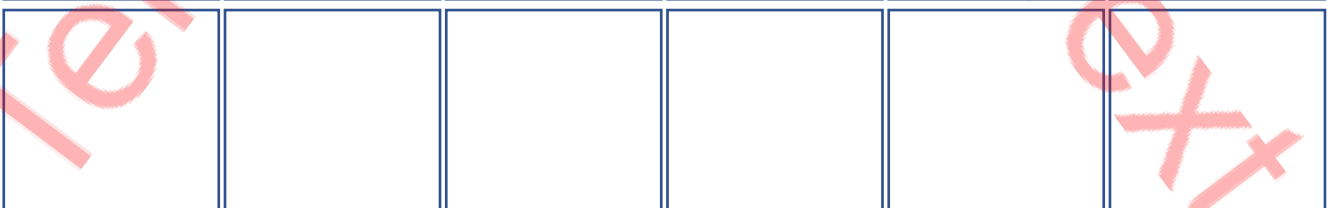
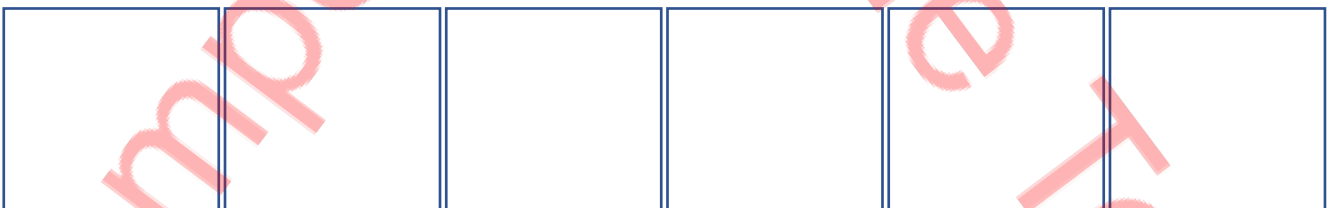
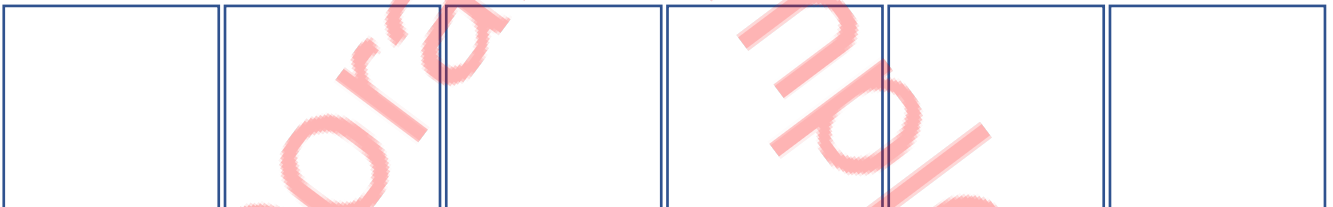
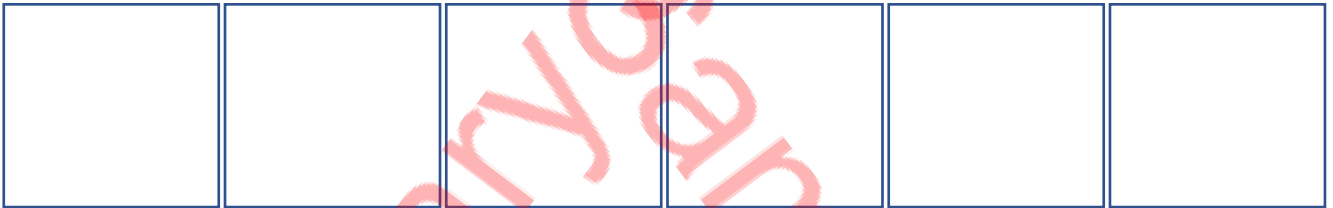
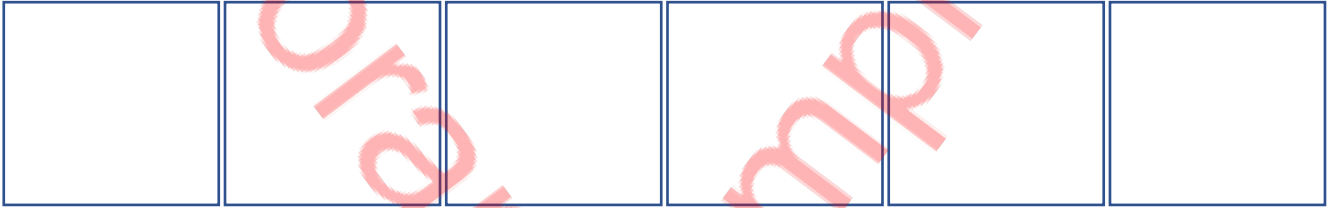
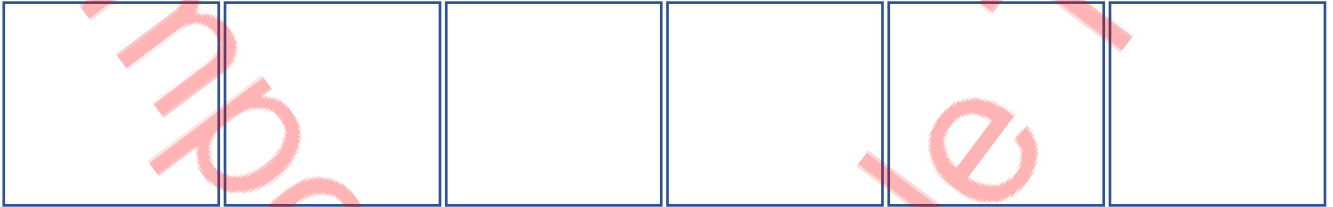
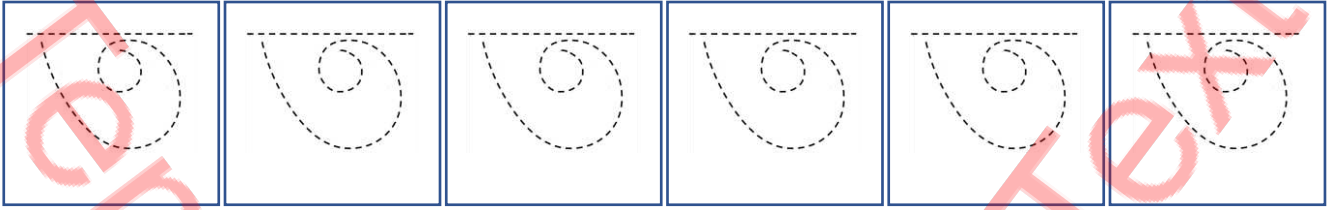

Student Name: \_\_\_\_\_

Verified By: \_\_\_\_\_

Class: \_\_\_\_\_

Date: \_\_\_\_\_

Copy Colour

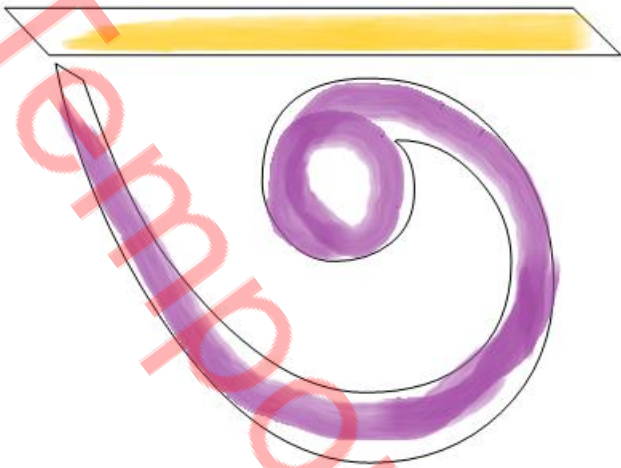

Colour it

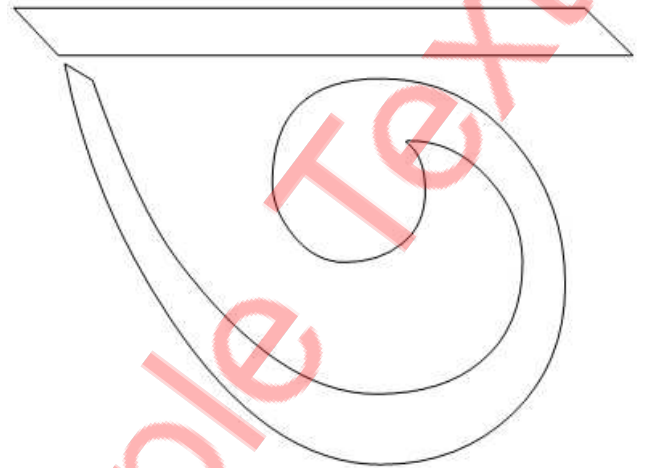

Write it

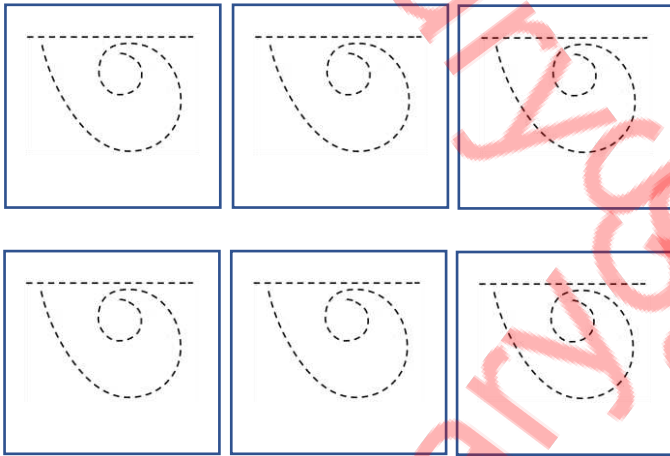

Find it

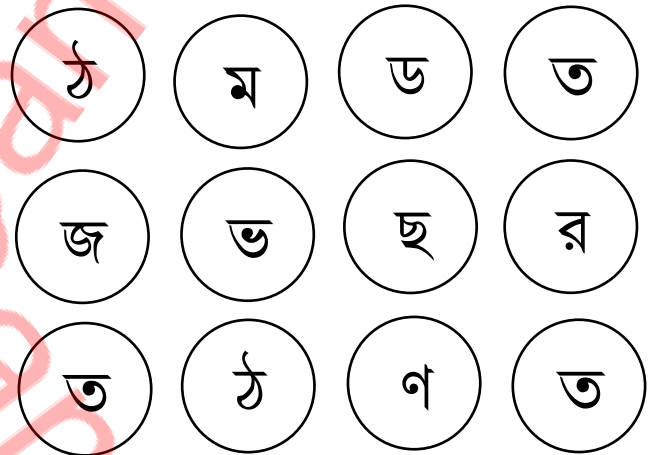

Connect the circle

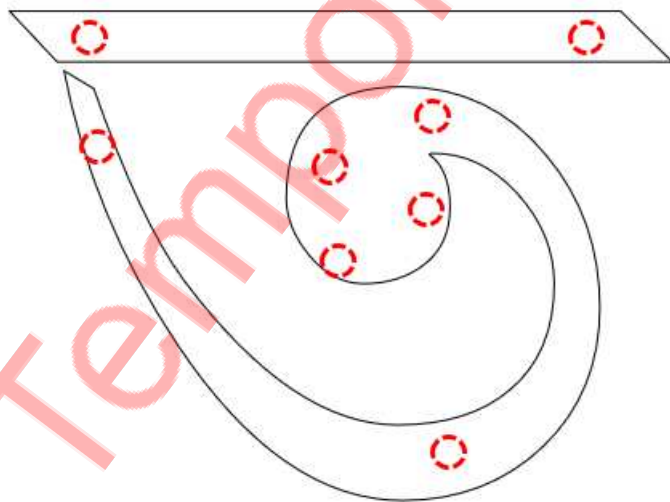

Do it

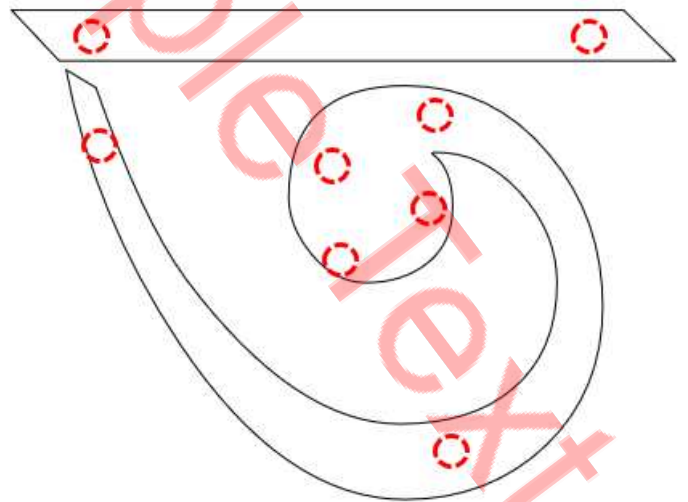

Student Name: \_\_\_\_\_

Verified By: \_\_\_\_\_

Class: \_\_\_\_\_

Date: \_\_\_\_\_

# Pick the Path Find the Correct Alphabet

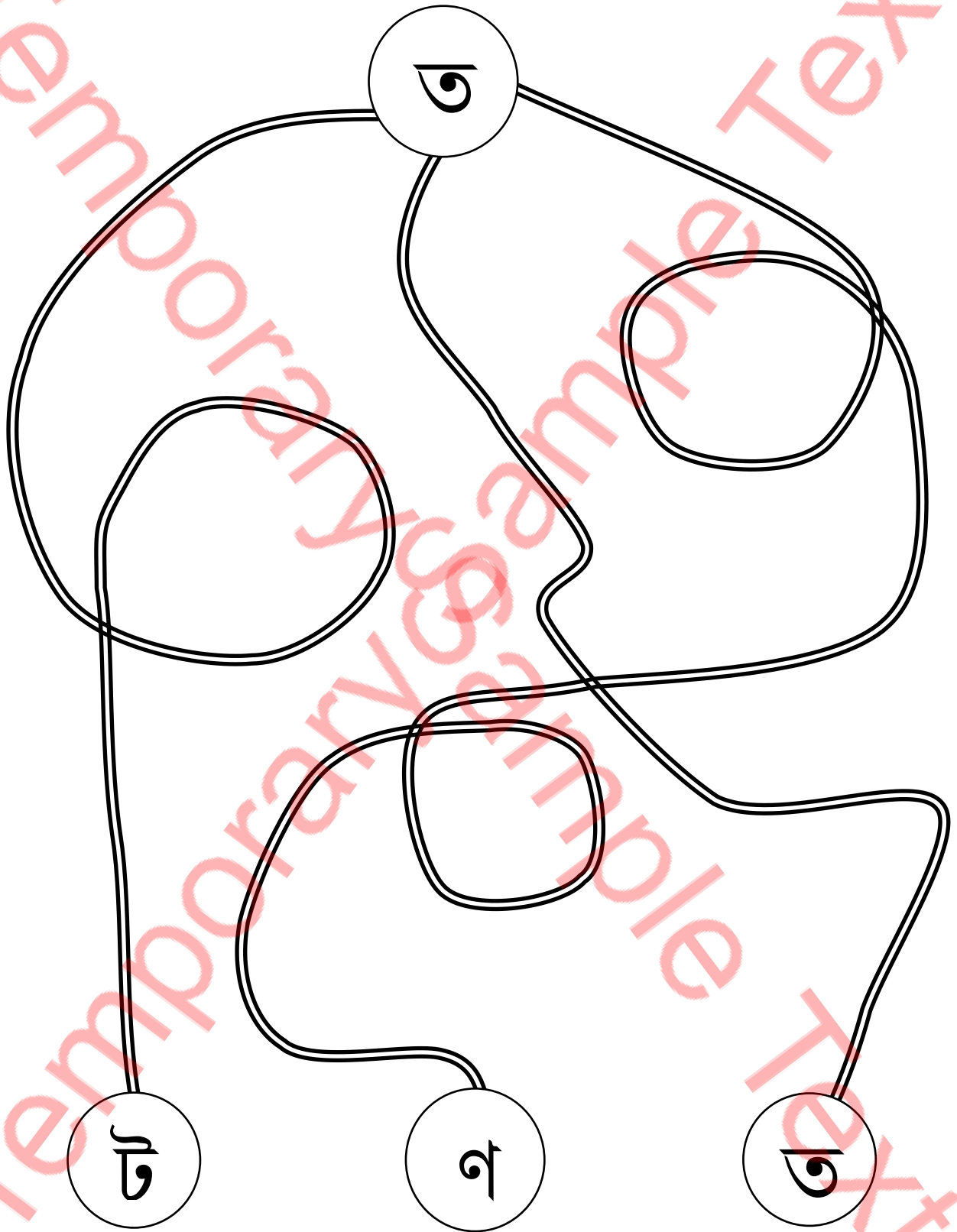

Student Name: \_\_\_\_\_

Verified By: \_\_\_\_\_

Class: \_\_\_\_\_

Date: \_\_\_\_\_



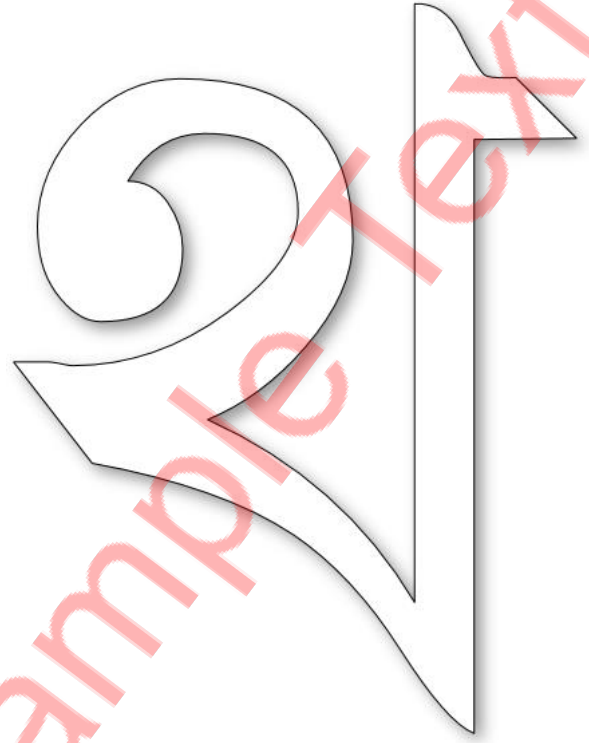
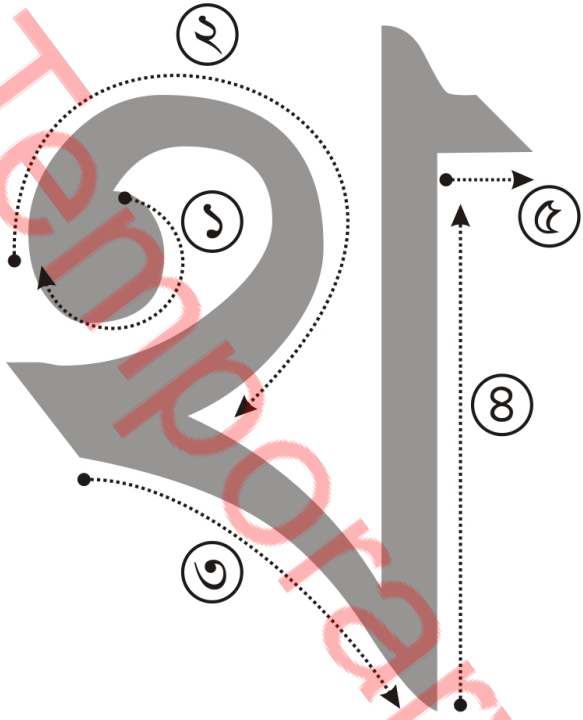

Follow the above steps

Colour it accordingly

ক	খ	গ	ঘ	ঙ	চ	ছ	জ
ঝ	ঞ	ট	ঠ	ড	ঢ	ণ	ত
থ	দ	ধ	ন	প	ফ	ব	ভ
ম	য	ষ	র	ৱ	শ	ষ	স
হ	ক্ষ	ড়	ঢ়	য়	ং	ঃ	়

Student Name: \_\_\_\_\_

Verified By: \_\_\_\_\_

Class: \_\_\_\_\_

Date: \_\_\_\_\_

## Trace It

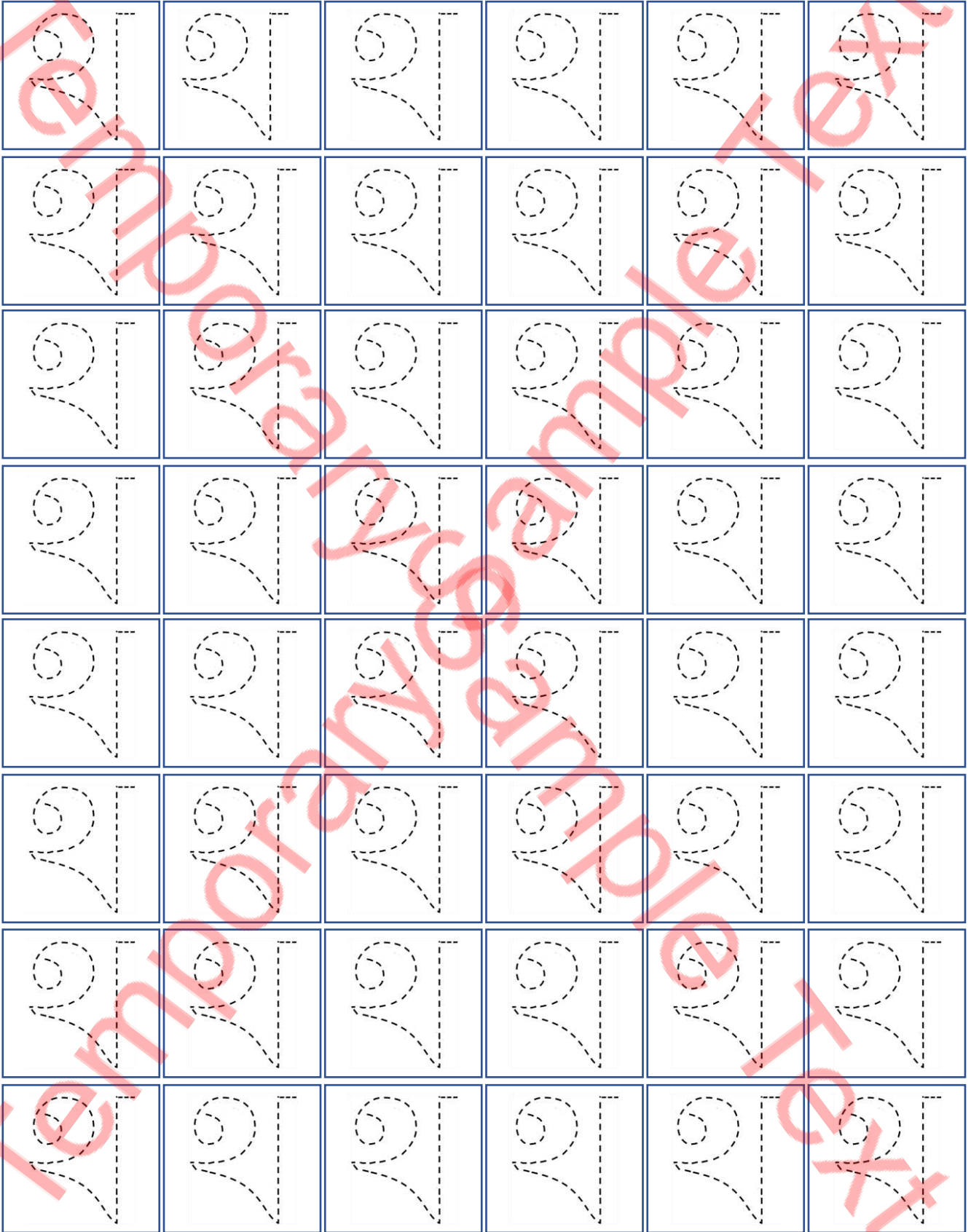

Student Name: \_\_\_\_\_

Verified By: \_\_\_\_\_

Class: \_\_\_\_\_

Date: \_\_\_\_\_

# Trace it

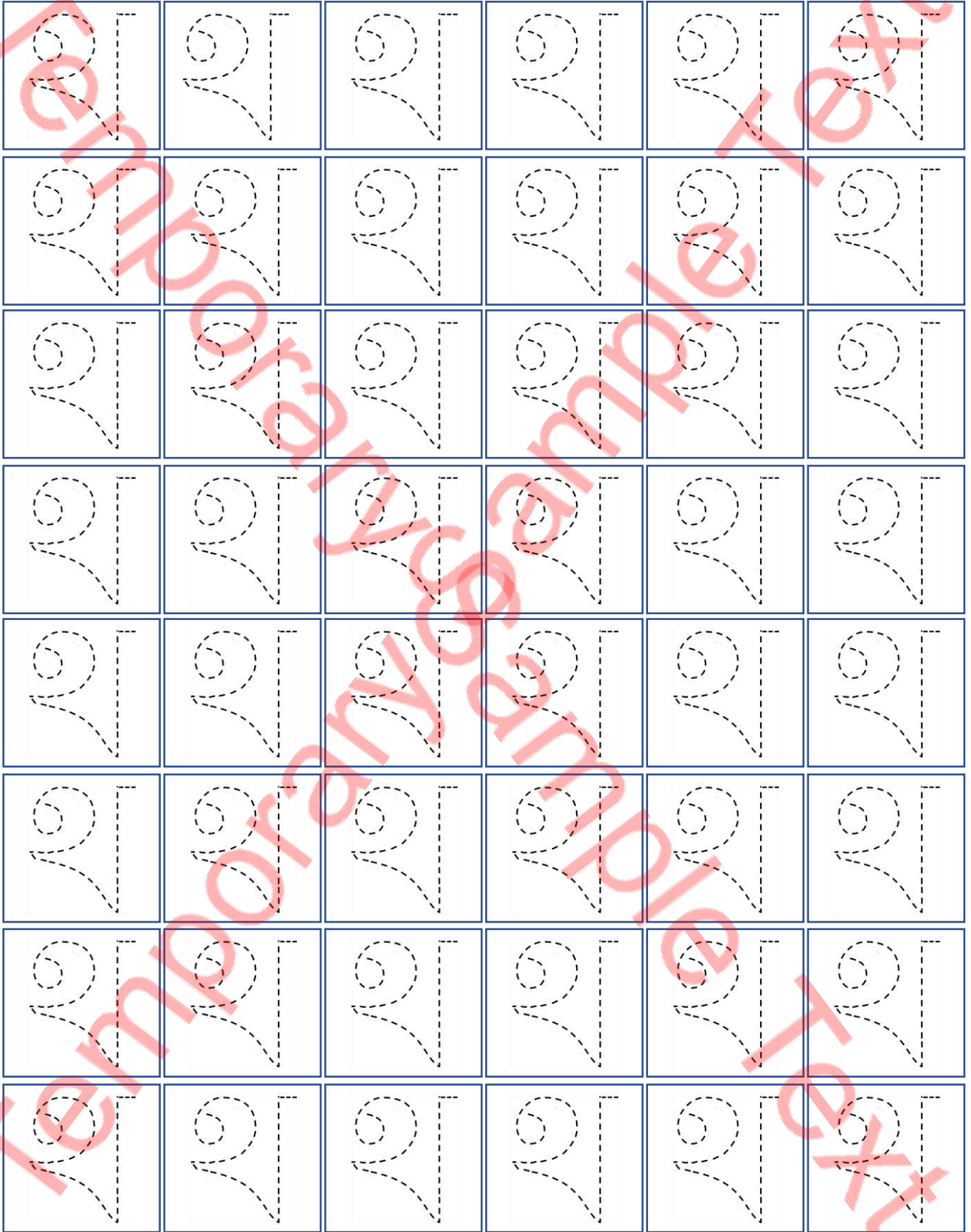

Student Name: \_\_\_\_\_

Verified By: \_\_\_\_\_

Class: \_\_\_\_\_

Date: \_\_\_\_\_

## Write it

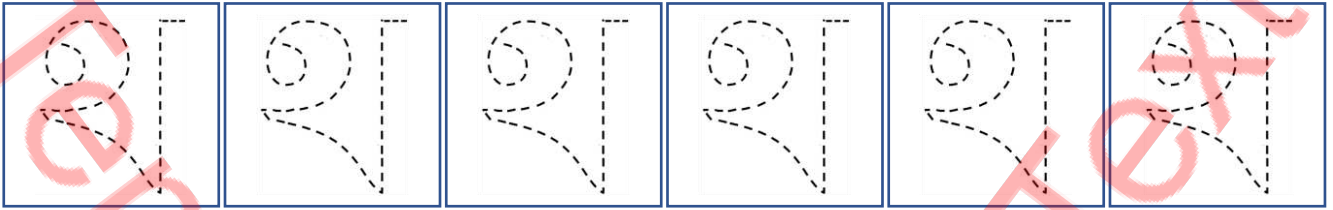

Student Name: \_\_\_\_\_

Verified By: \_\_\_\_\_

Class: \_\_\_\_\_

Date: \_\_\_\_\_

Copy Colour



Colour it

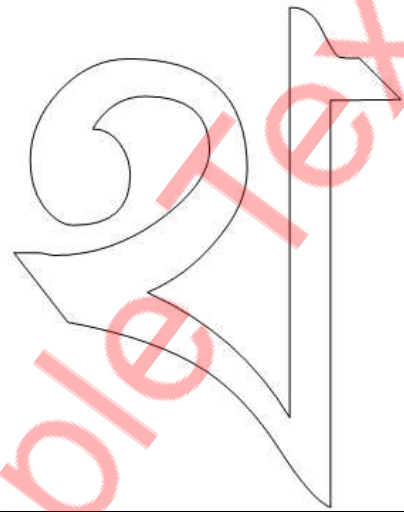

Write it

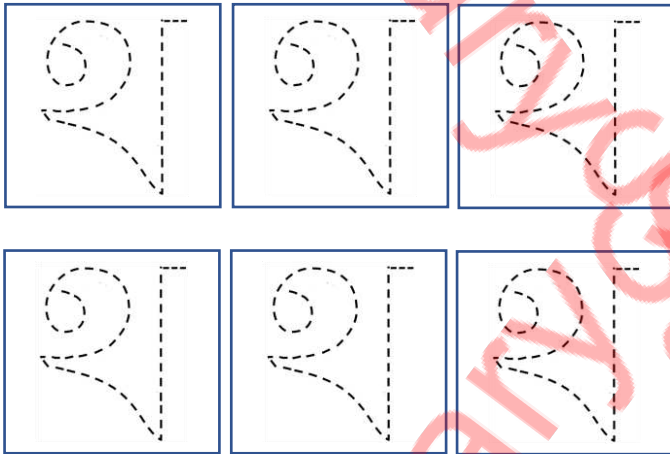

Find it



Connect the circle

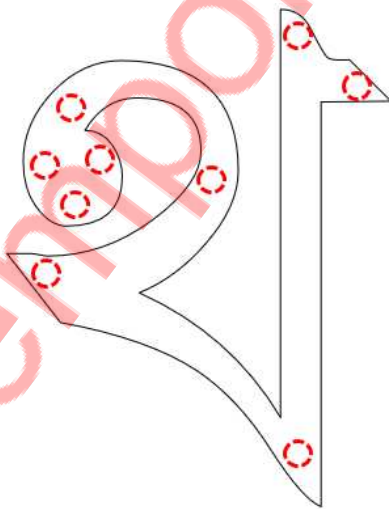

Do it

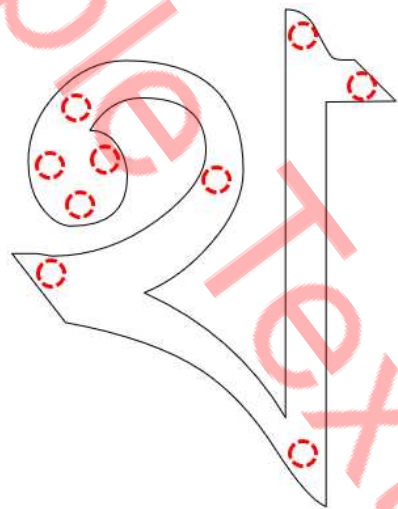

Student Name: \_\_\_\_\_

Verified By: \_\_\_\_\_

Class: \_\_\_\_\_

Date: \_\_\_\_\_

Pick the Path Find the Correct Alphabet

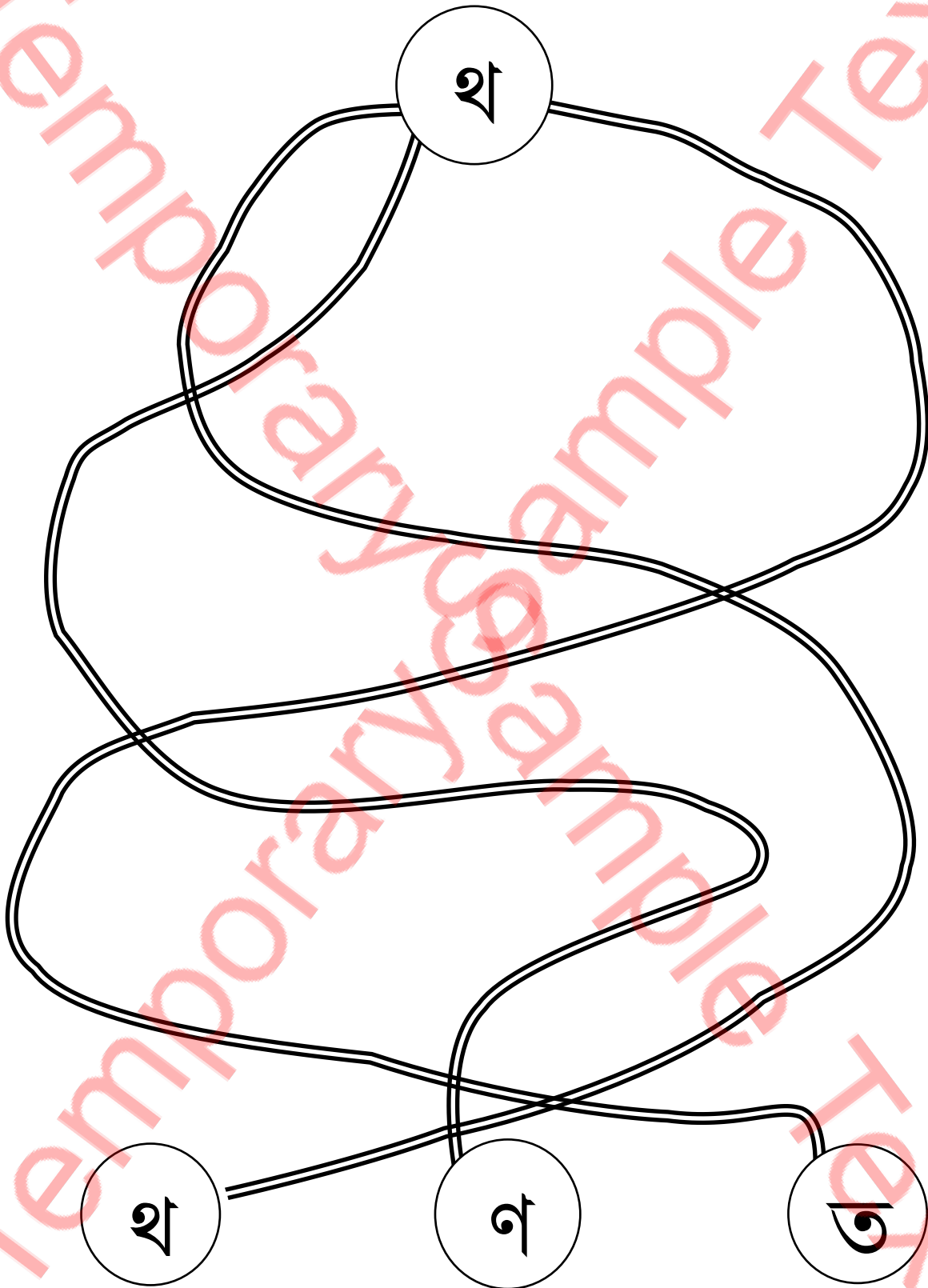

Student Name: \_\_\_\_\_

Verified By: \_\_\_\_\_

Class: \_\_\_\_\_

Date: \_\_\_\_\_



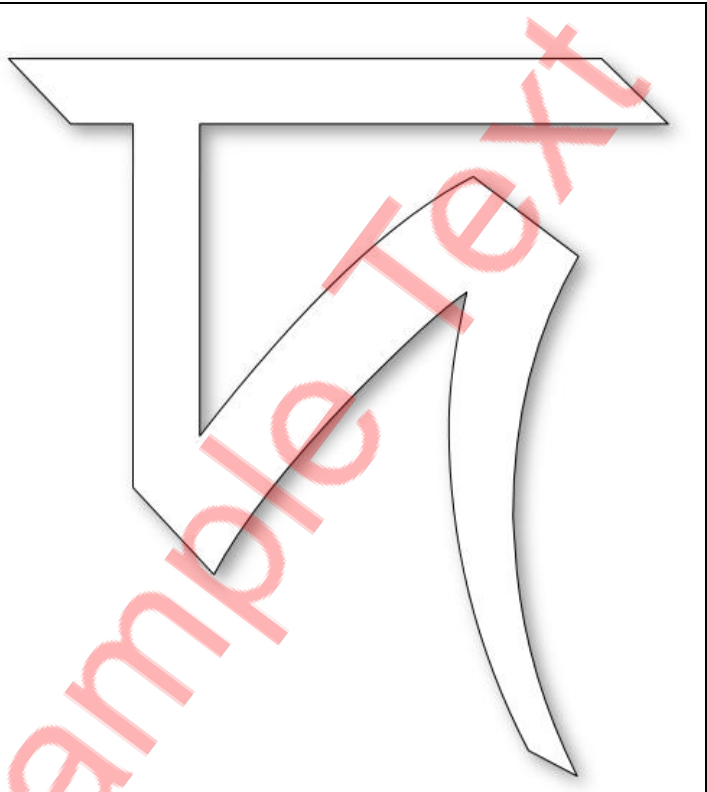
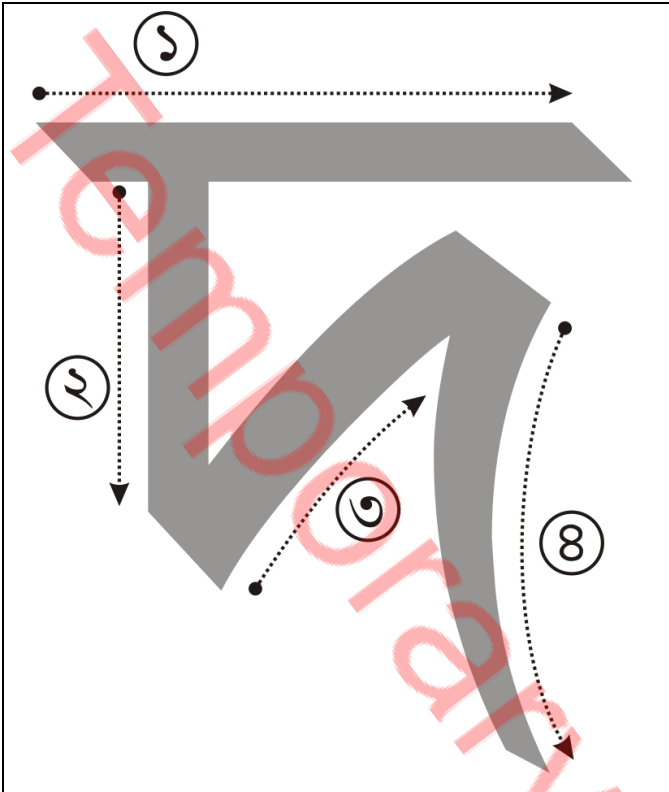

Follow the above steps

Colour it accordingly

ক	খ	গ	ঘ	ঙ	চ	ছ	জ
ঝ	ঞ	ট	ঠ	ড	ঢ	ণ	ত
থ	দ	ধ	ন	প	ফ	ব	ভ
ম	য	র	ল	শ	ষ	স	
হ	ক্ষ	ড়	ঢ়	য়	ং	ঃ	়

Student Name: \_\_\_\_\_

Verified By: \_\_\_\_\_

Class: \_\_\_\_\_

Date: \_\_\_\_\_

## Trace It

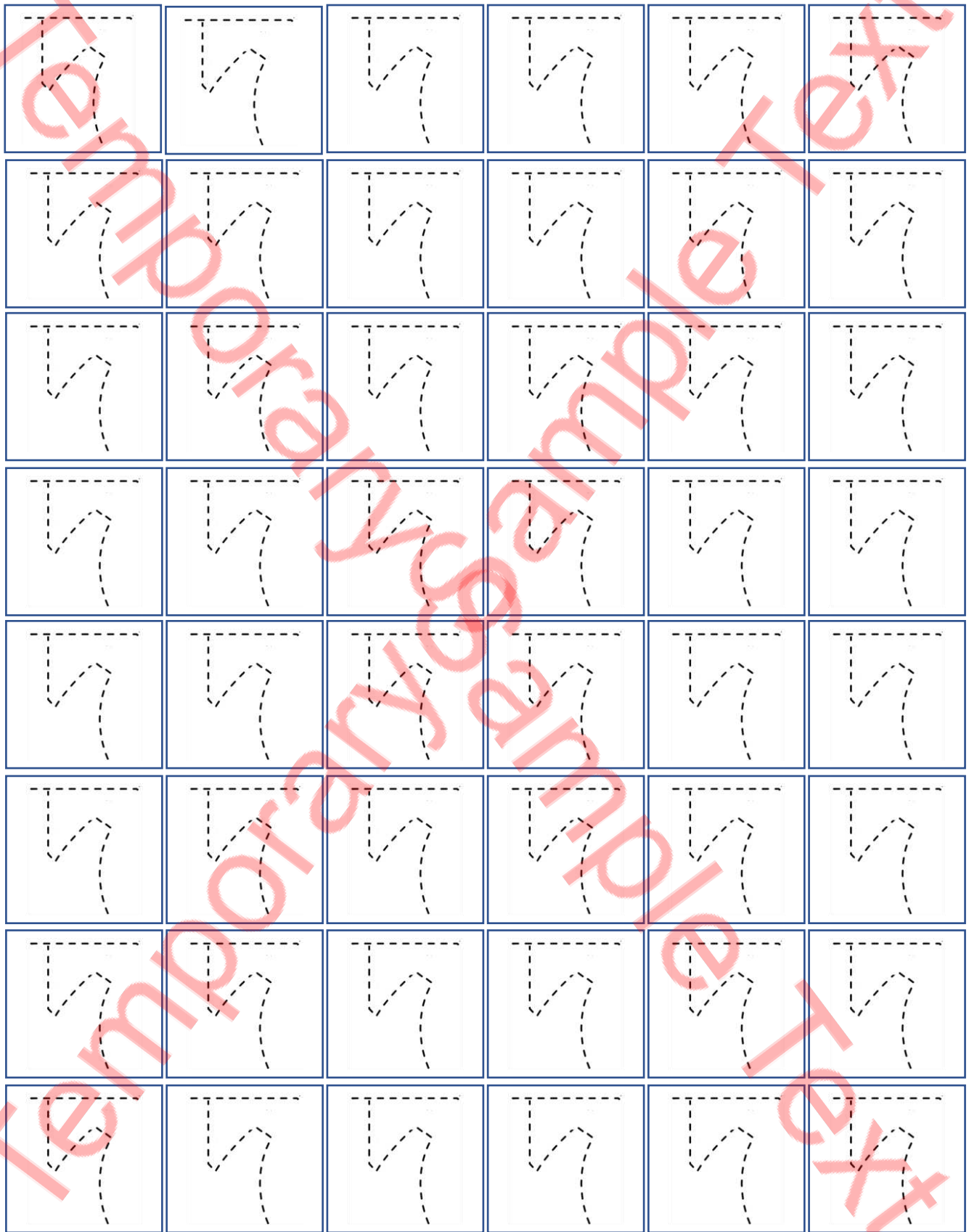

Student Name: \_\_\_\_\_

Verified By: \_\_\_\_\_

Class: \_\_\_\_\_

Date: \_\_\_\_\_

# Trace it

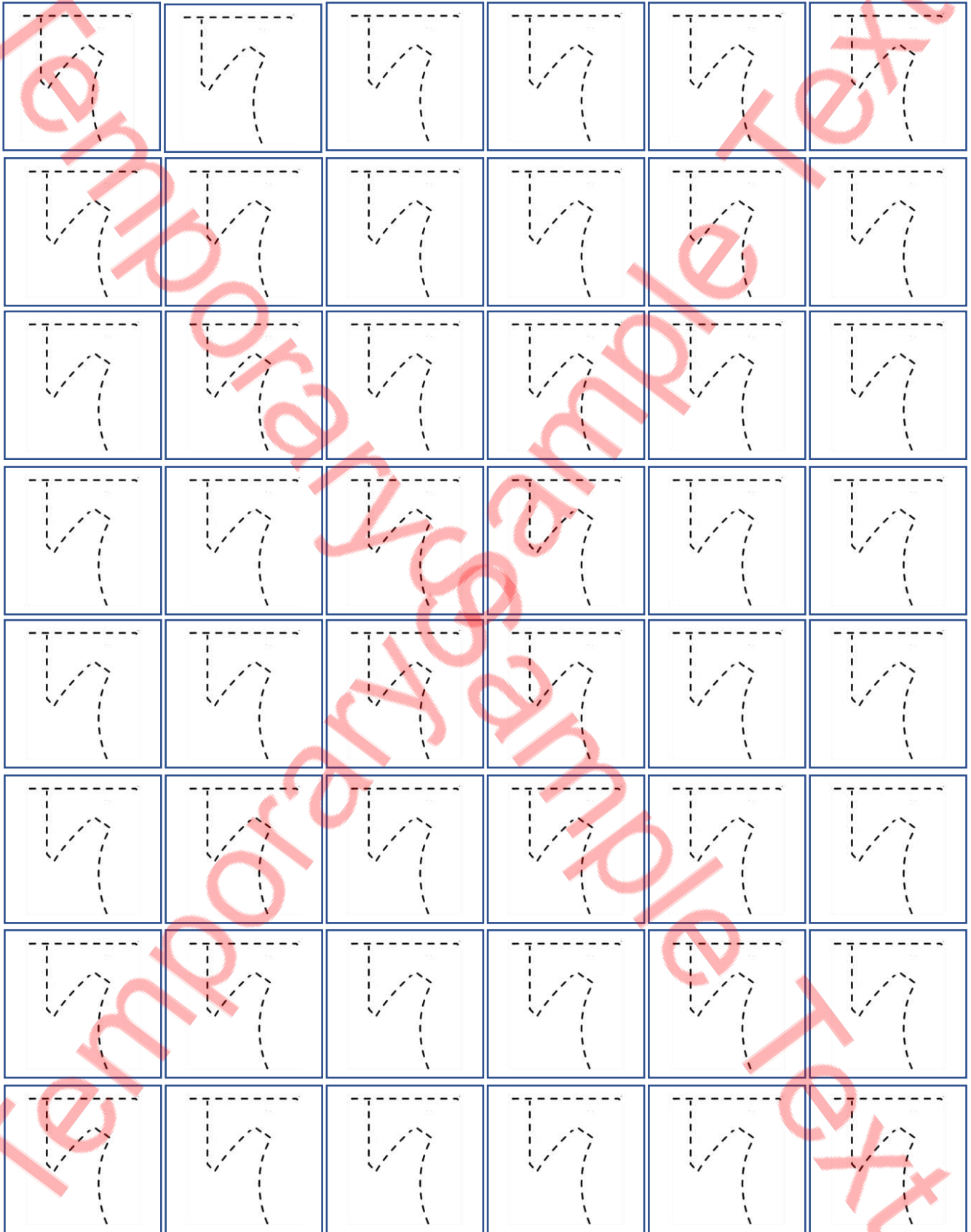

Student Name: \_\_\_\_\_

Verified By: \_\_\_\_\_

Class: \_\_\_\_\_

Date: \_\_\_\_\_

# Write it

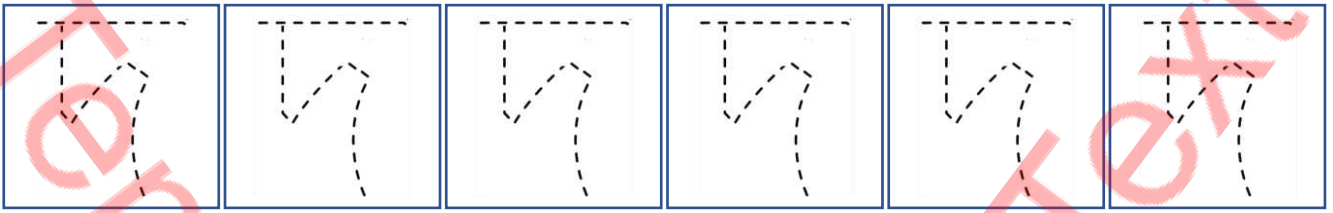



Student Name: \_\_\_\_\_

Verified By: \_\_\_\_\_

Class: \_\_\_\_\_

Date: \_\_\_\_\_

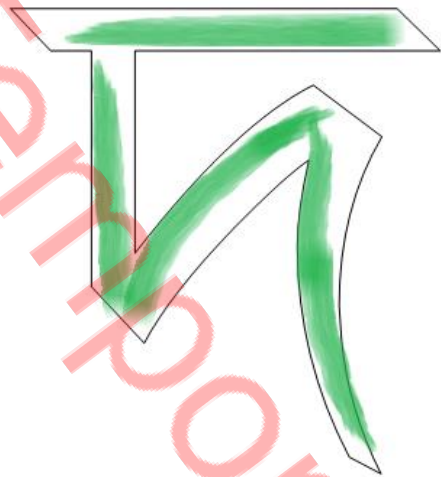
Copy Colour



Colour it

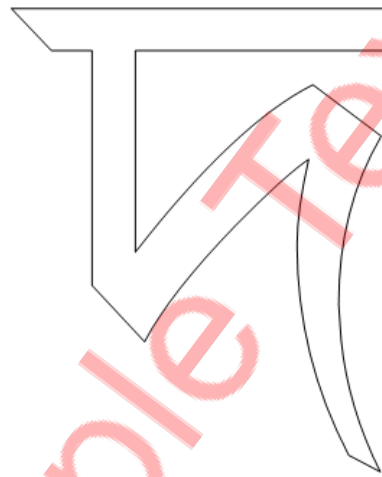

Write it

Find it

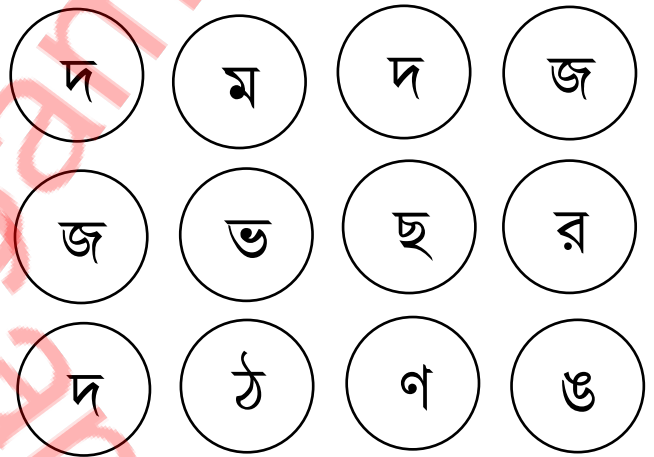
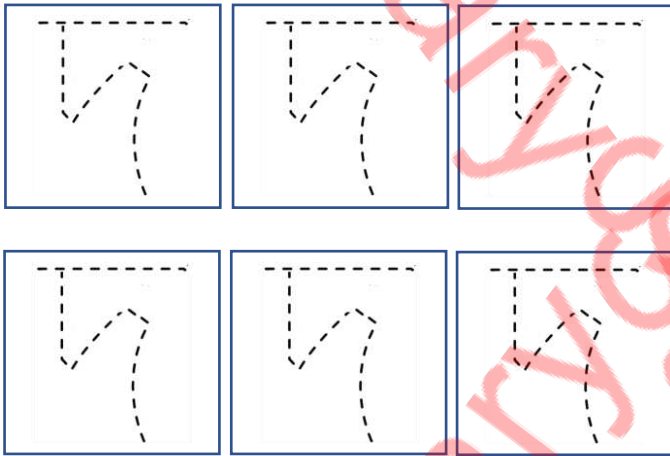

Connect the circle

Do it

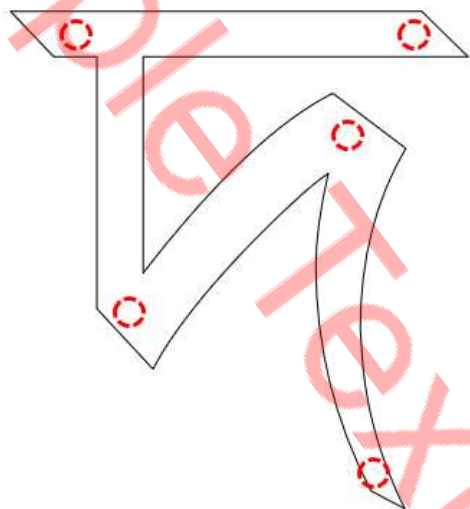
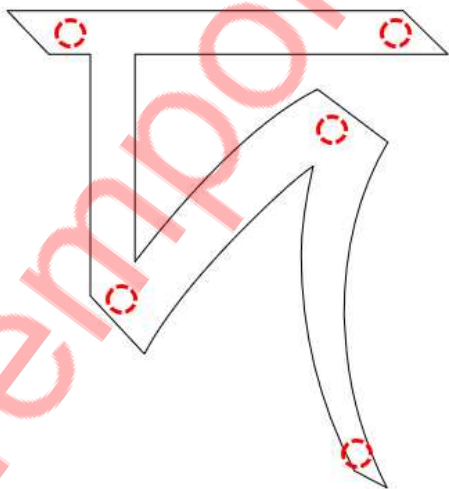

Student Name: \_\_\_\_\_

Verified By: \_\_\_\_\_

Class: \_\_\_\_\_

Date: \_\_\_\_\_

# Pick the Path Find the Correct Alphabet

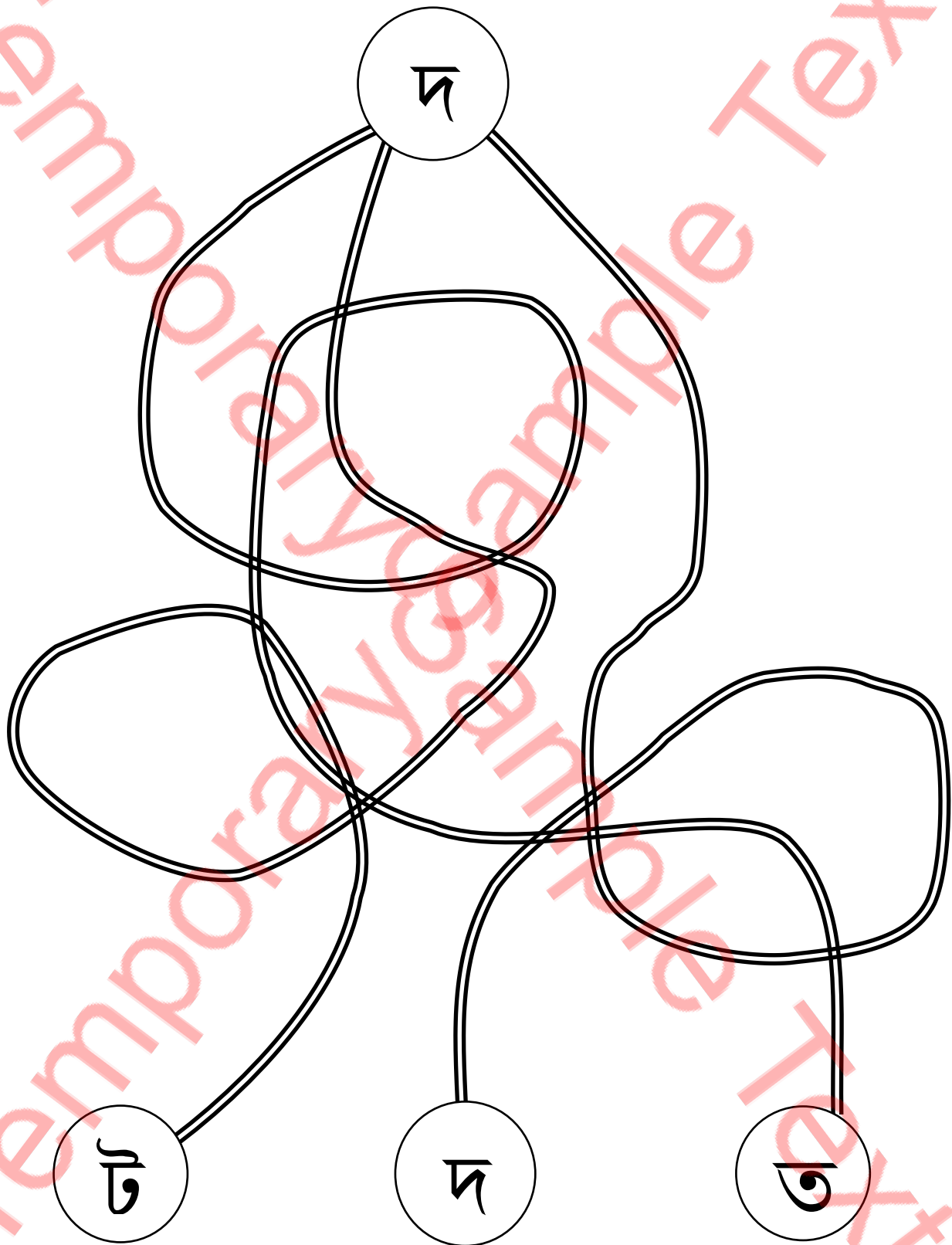

Student Name: \_\_\_\_\_

Verified By: \_\_\_\_\_

Class: \_\_\_\_\_

Date: \_\_\_\_\_



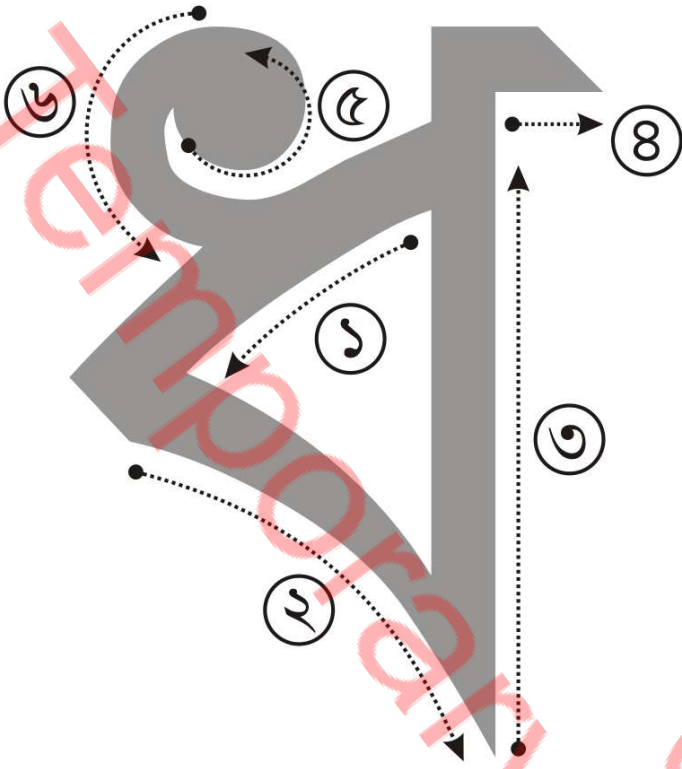

Follow the above steps

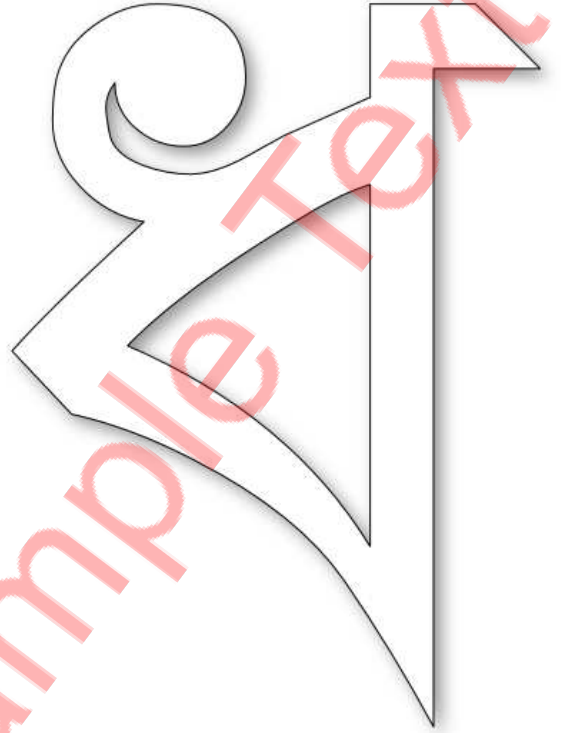

Colour it accordingly

ক	খ	গ	ঘ	ঙ	চ	ছ	জ
ঝ	ঞ	ট	ঠ	ড	ঢ	ণ	ত
থ	দ	ধ	ন	প	ফ	ব	ভ
ম	য	ষ	প্র	র	শ	ষ	স
হ	ক্ষ	ড়	ঢ়	য়	ং	ঃ	ঁ

Student Name: \_\_\_\_\_

Verified By: \_\_\_\_\_

Class: \_\_\_\_\_

Date: \_\_\_\_\_

## Trace It

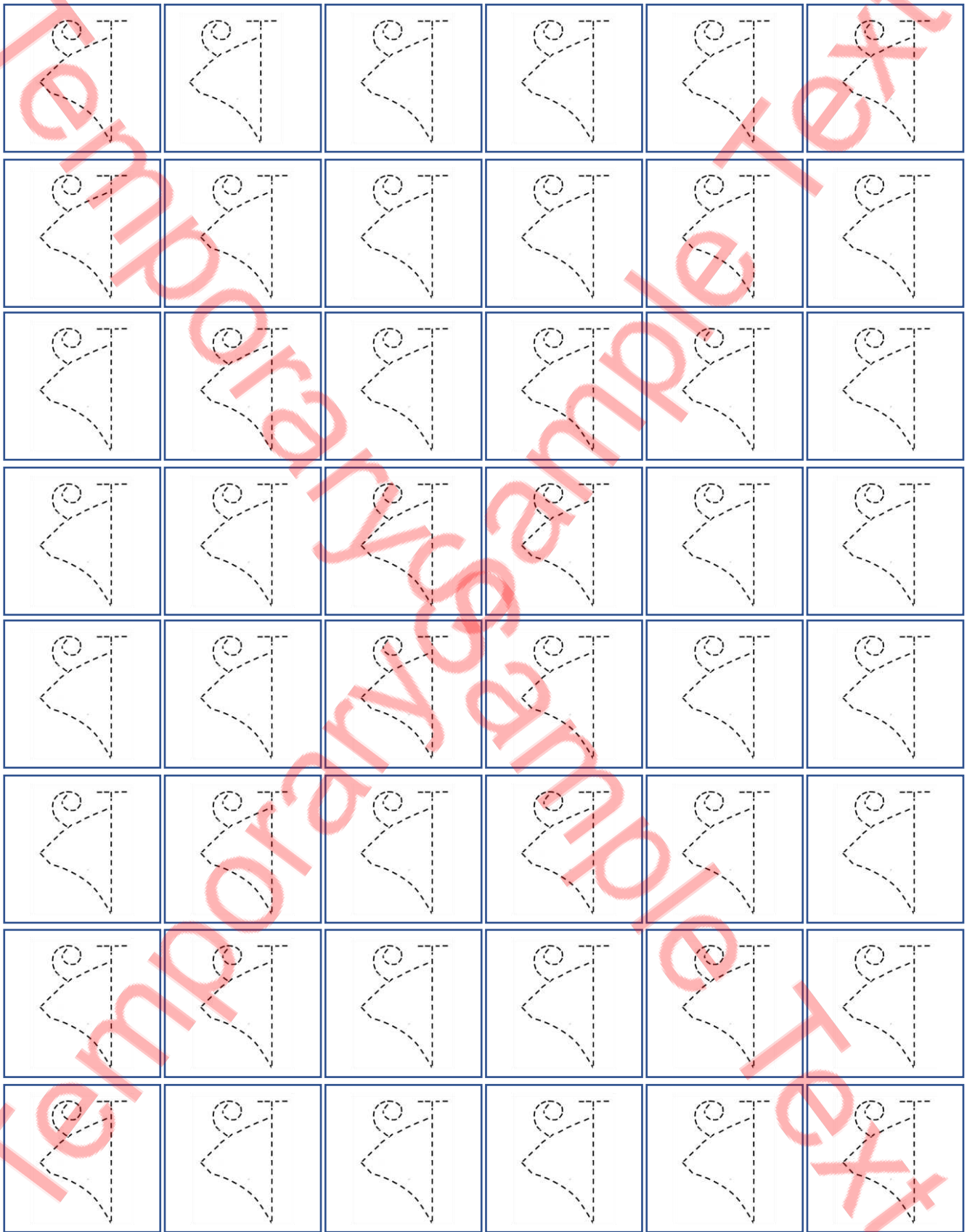

Student Name: \_\_\_\_\_

Verified By: \_\_\_\_\_

Class: \_\_\_\_\_

Date: \_\_\_\_\_

# Trace it

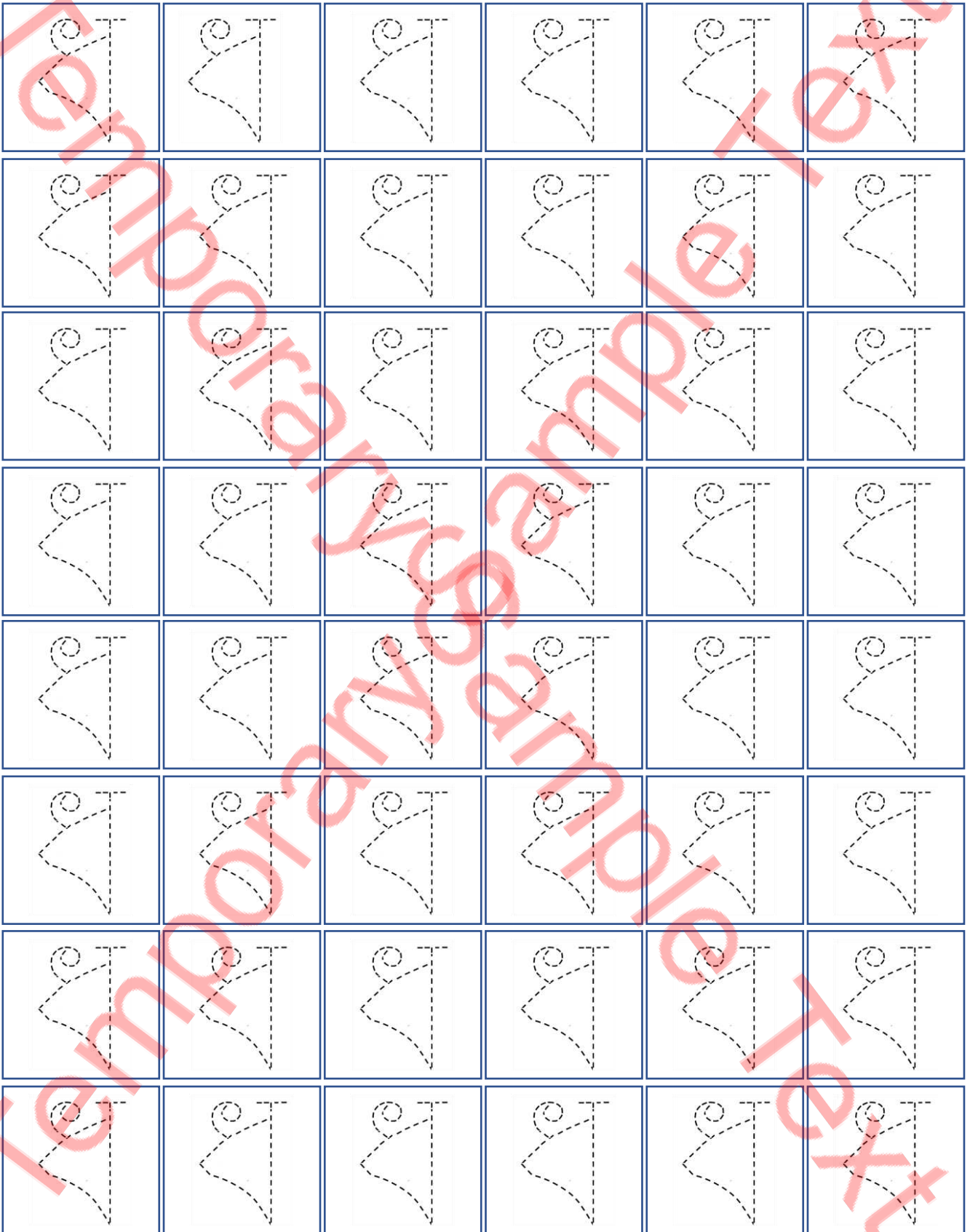

Student Name: \_\_\_\_\_

Verified By: \_\_\_\_\_

Class: \_\_\_\_\_

Date: \_\_\_\_\_

Write it

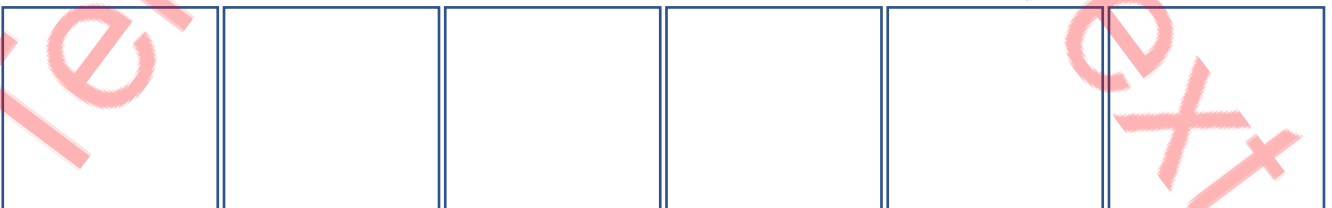
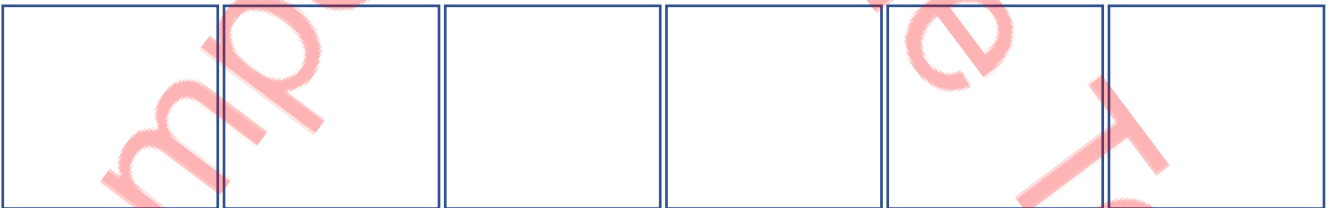
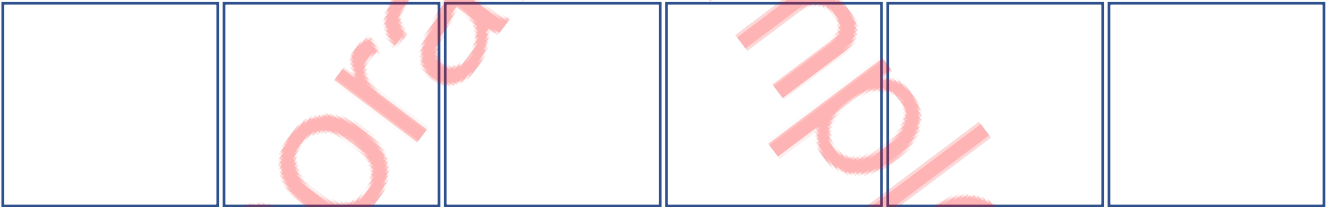
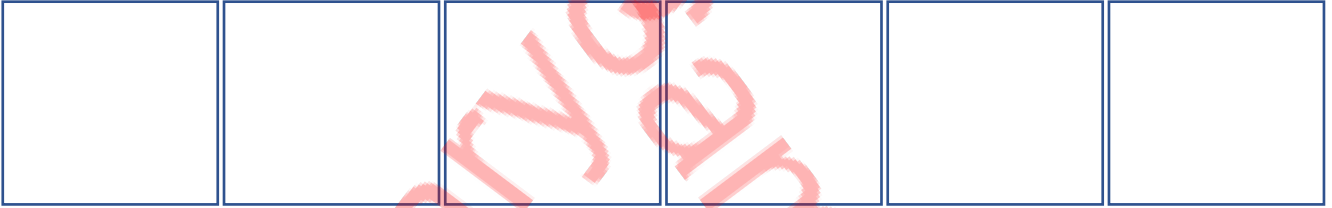
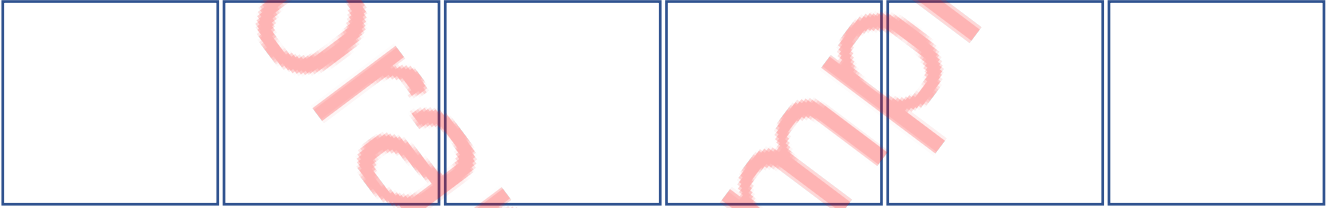
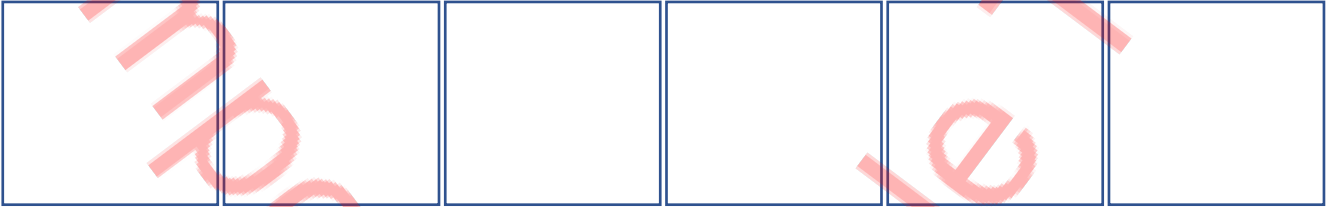
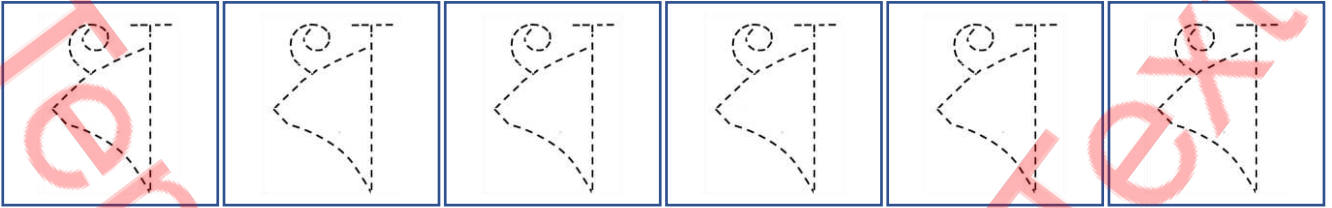

Student Name: \_\_\_\_\_

Verified By: \_\_\_\_\_

Class: \_\_\_\_\_

Date: \_\_\_\_\_

Copy Colour

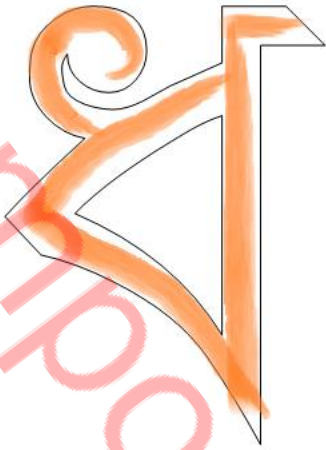

Colour it



Write it

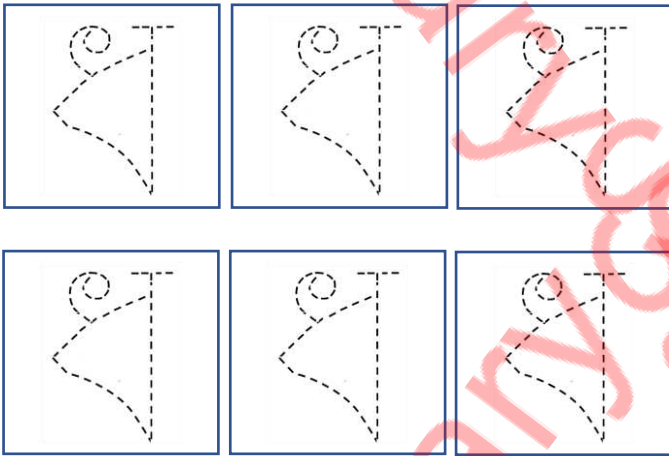

Find it

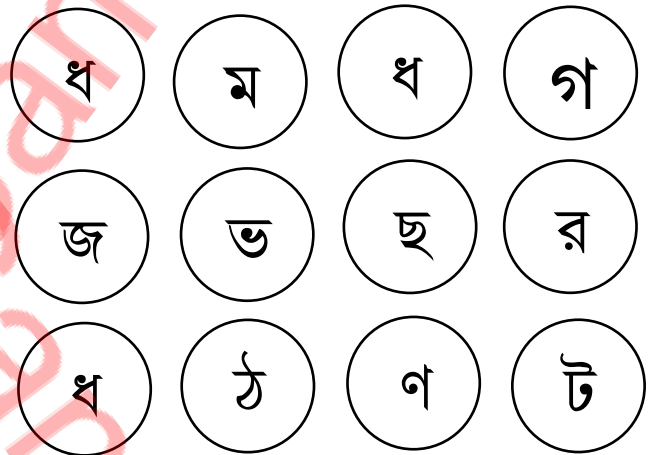

Connect the circle

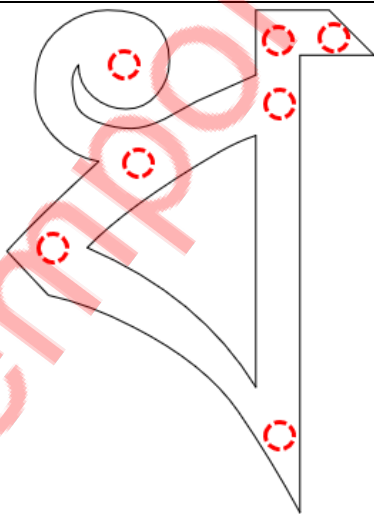

Do it

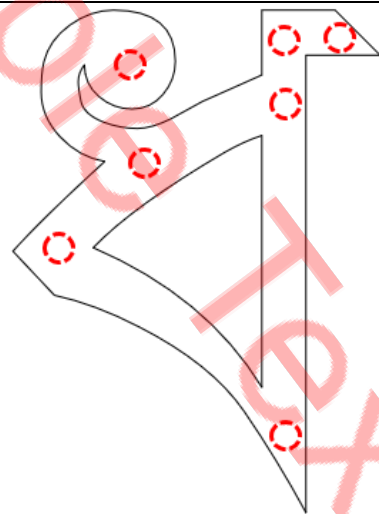

Student Name: \_\_\_\_\_

Verified By: \_\_\_\_\_

Class: \_\_\_\_\_

Date: \_\_\_\_\_

# Pick the Path Find the Correct Alphabet

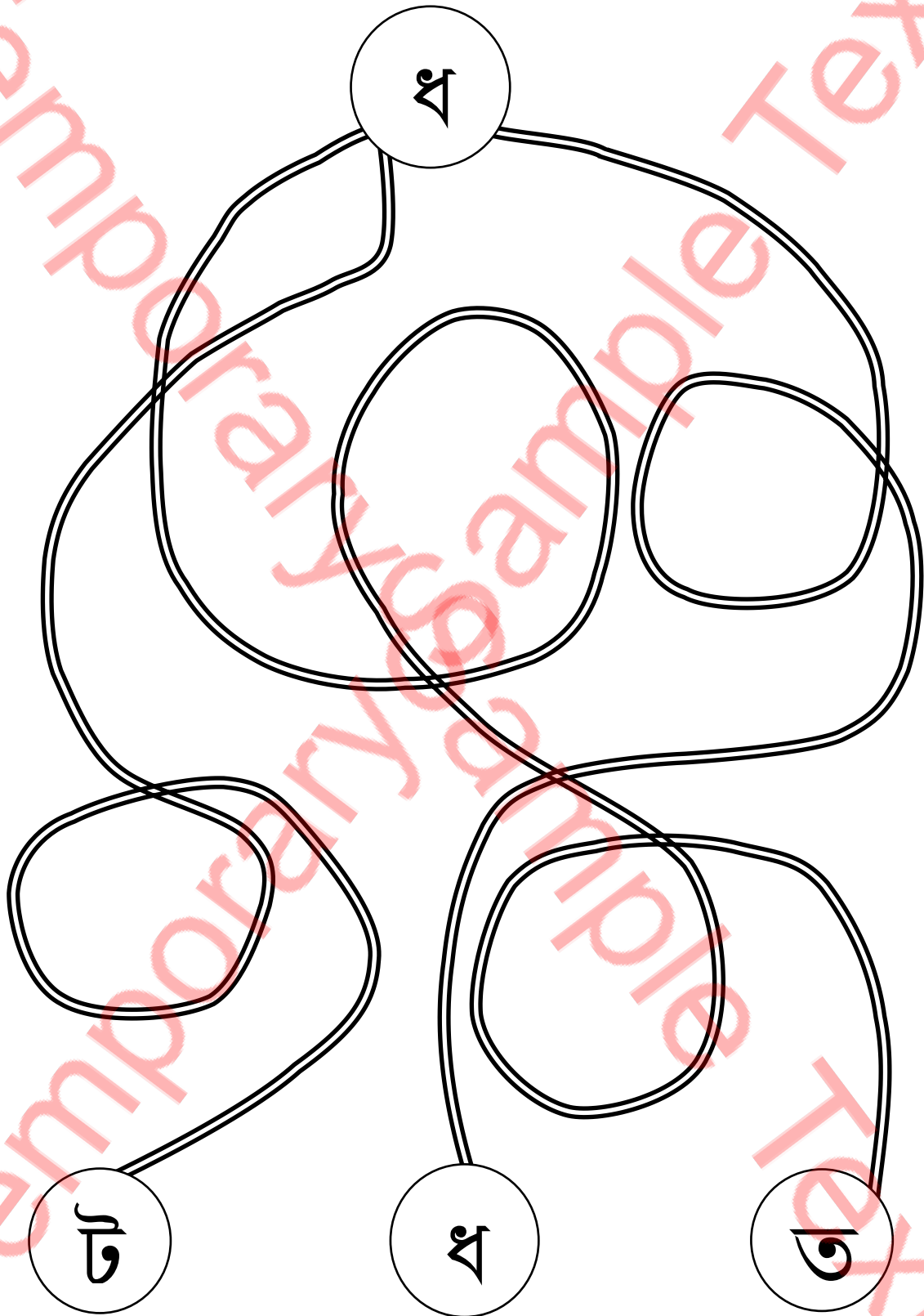

Student Name: \_\_\_\_\_

Verified By: \_\_\_\_\_

Class: \_\_\_\_\_

Date: \_\_\_\_\_



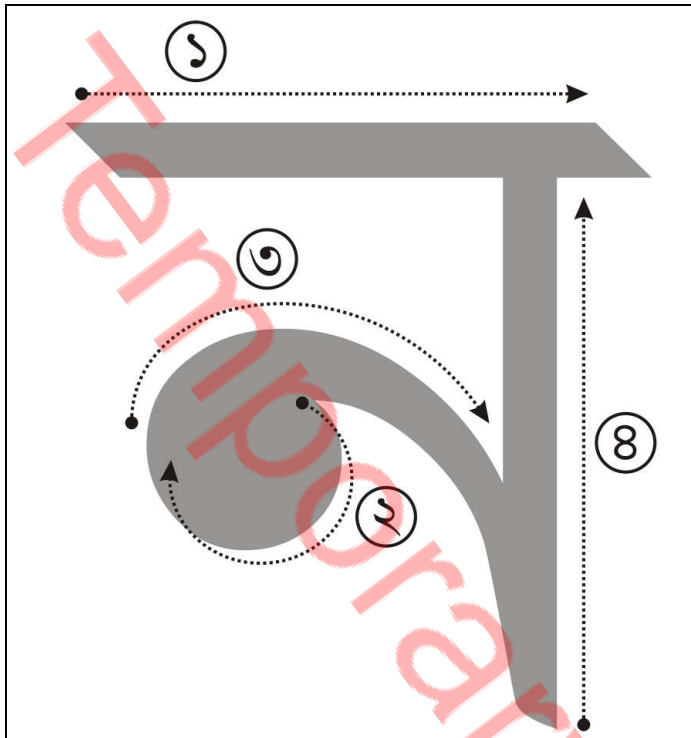

Follow the above steps

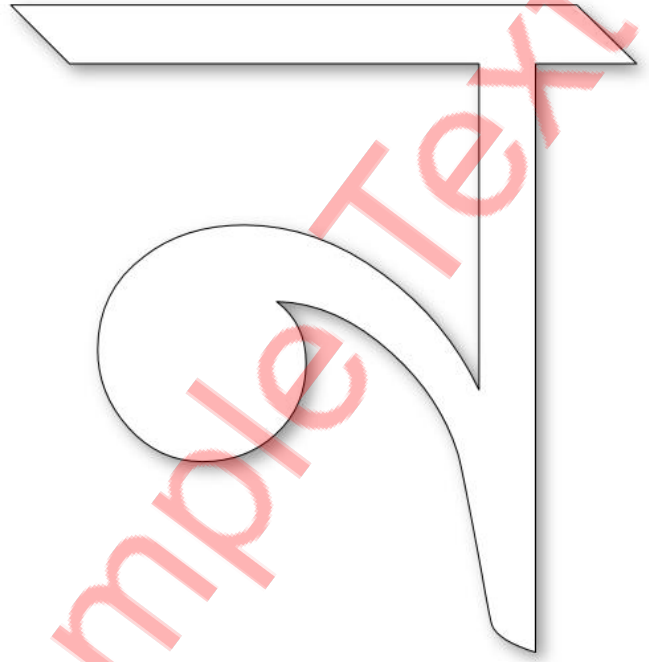

Colour it accordingly

ক	খ	গ	ঘ	ঙ	চ	ছ	জ
ঝ	ঞ	ট	ঠ	ড	ঢ	ণ	ত
থ	দ	ধ	ন	প	ফ	ব	ভ
ম	য	ষ	র	ল	শ	ষ	স
হ	ক্ষ	ড়	ঢ়	য়	ং	ঃ	ঁ

Student Name: \_\_\_\_\_

Verified By: \_\_\_\_\_

Class: \_\_\_\_\_

Date: \_\_\_\_\_

## Trace It

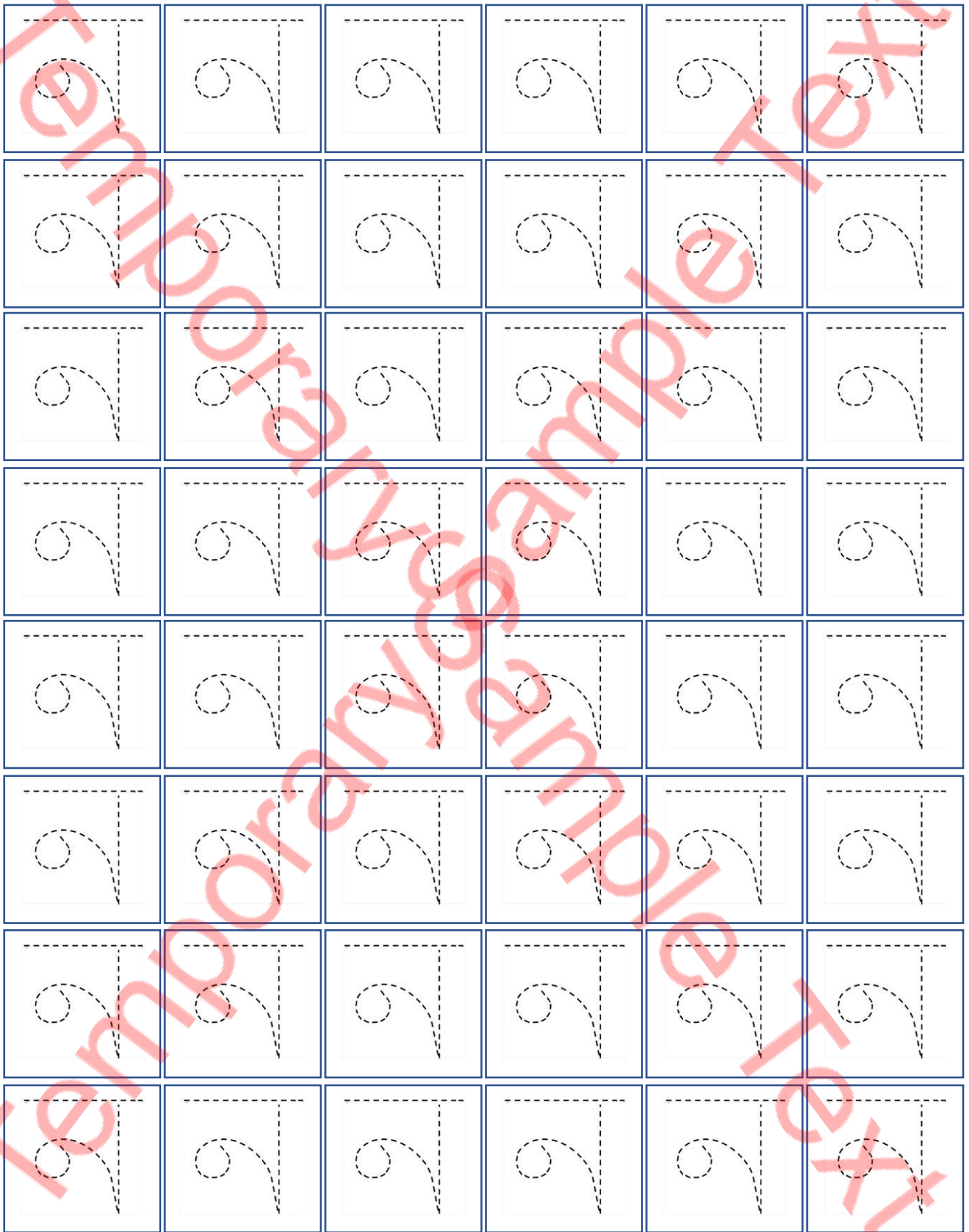

Student Name: \_\_\_\_\_

Verified By: \_\_\_\_\_

Class: \_\_\_\_\_

Date: \_\_\_\_\_

# Trace it

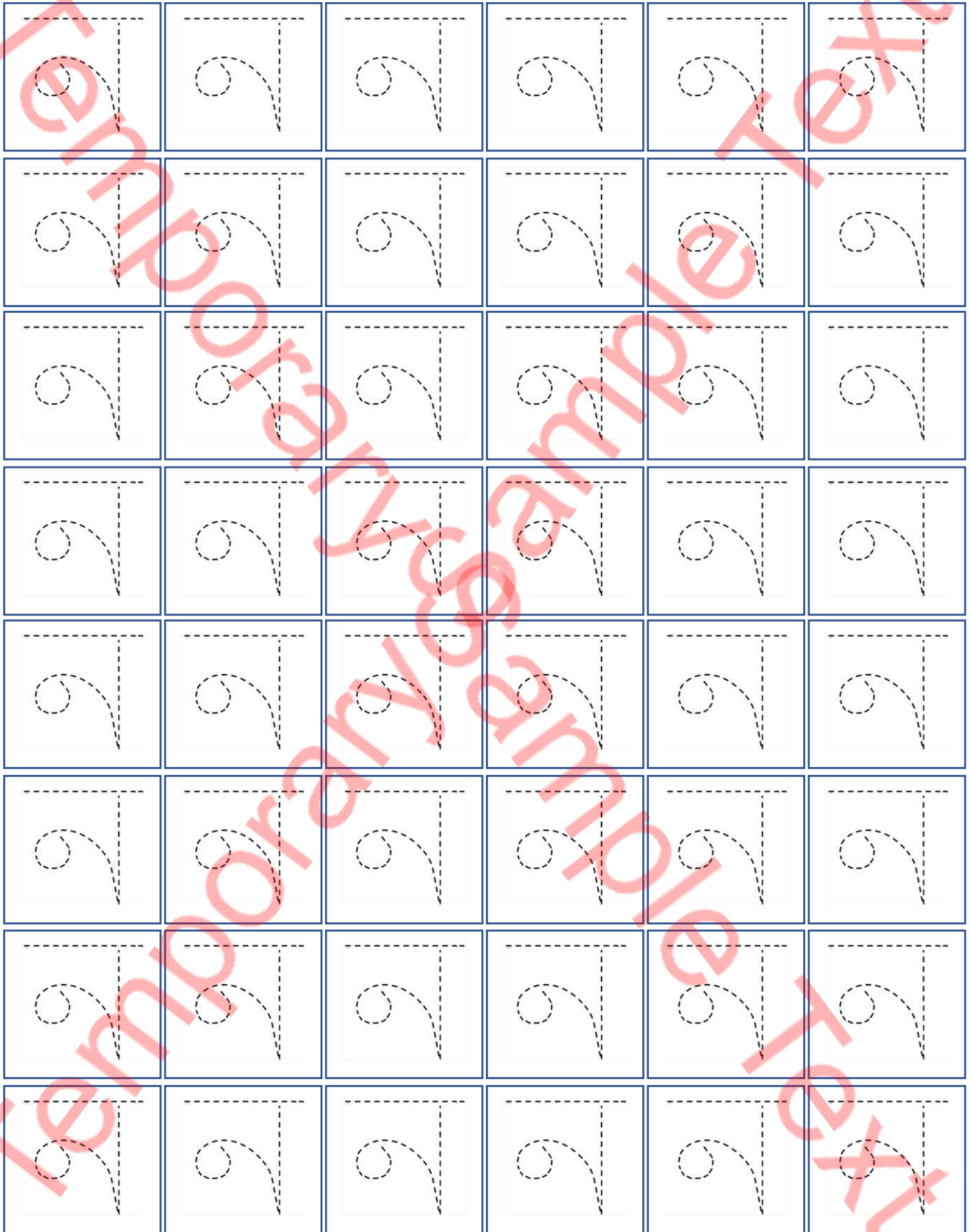

Student Name: \_\_\_\_\_

Verified By: \_\_\_\_\_

Class: \_\_\_\_\_

Date: \_\_\_\_\_

Write it

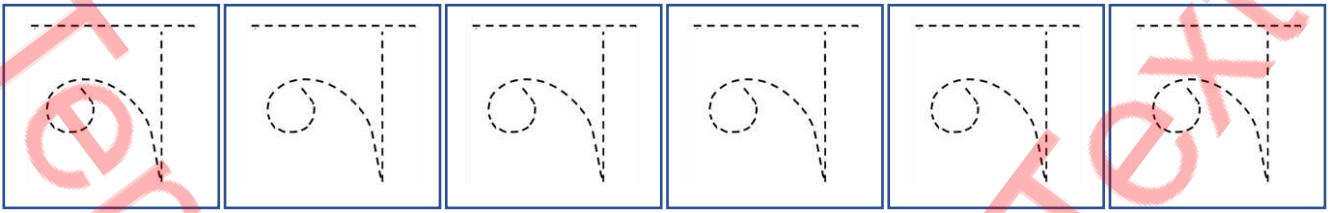



Student Name: \_\_\_\_\_

Verified By: \_\_\_\_\_

Class: \_\_\_\_\_

Date: \_\_\_\_\_

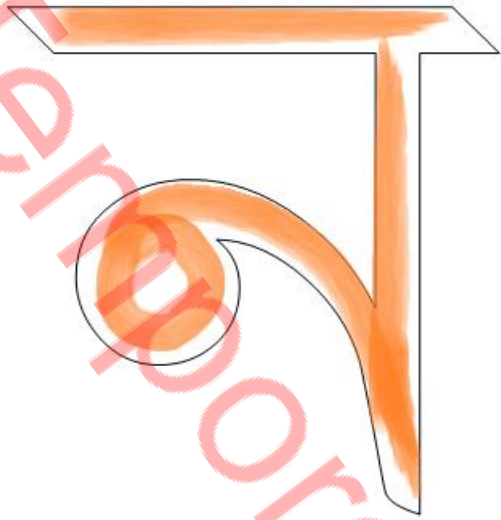
Copy Colour



Colour it

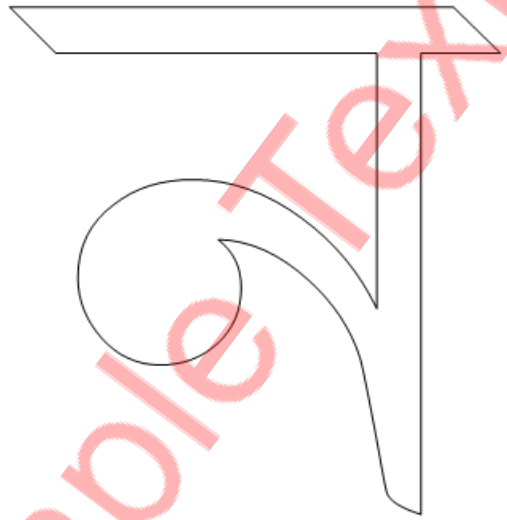

Write it

Find it

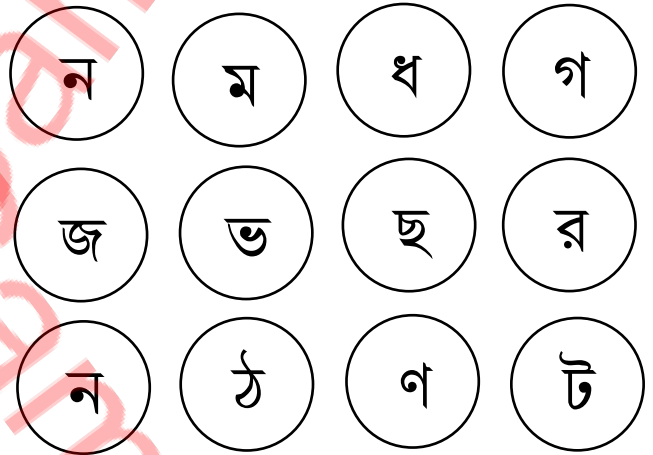
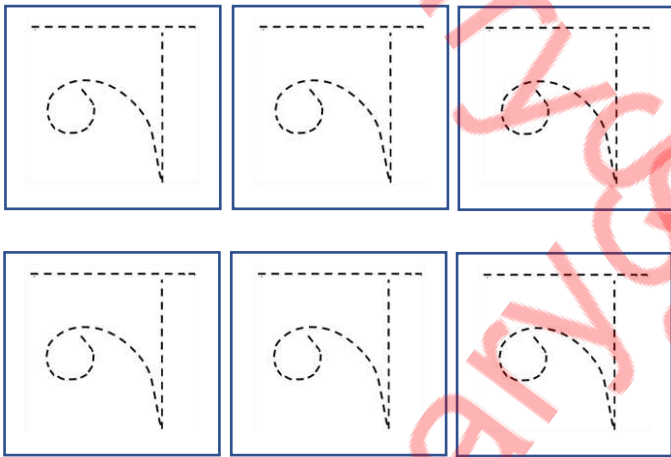

Connect the circle

Do it

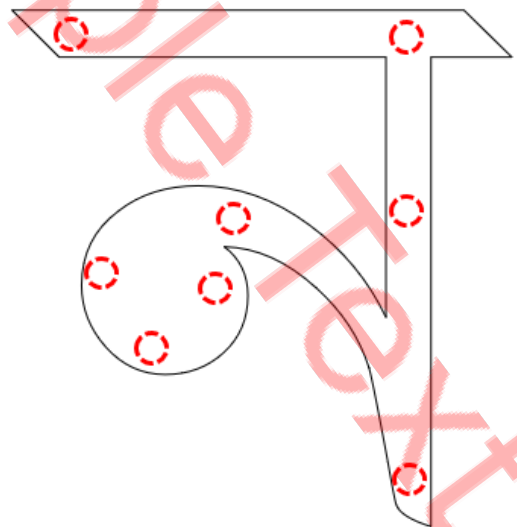
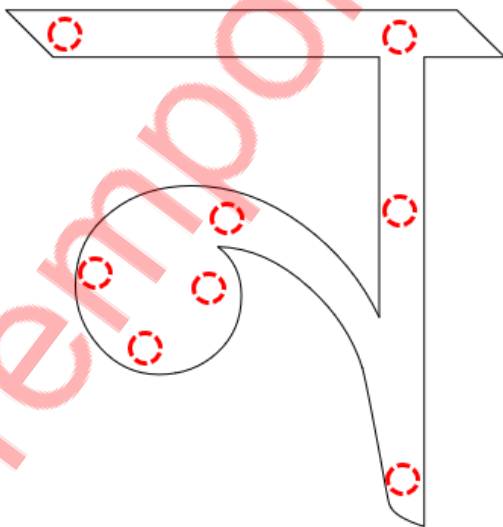

Student Name: \_\_\_\_\_

Verified By: \_\_\_\_\_

Class: \_\_\_\_\_

Date: \_\_\_\_\_

# Pick the Path Find the Correct Alphabet

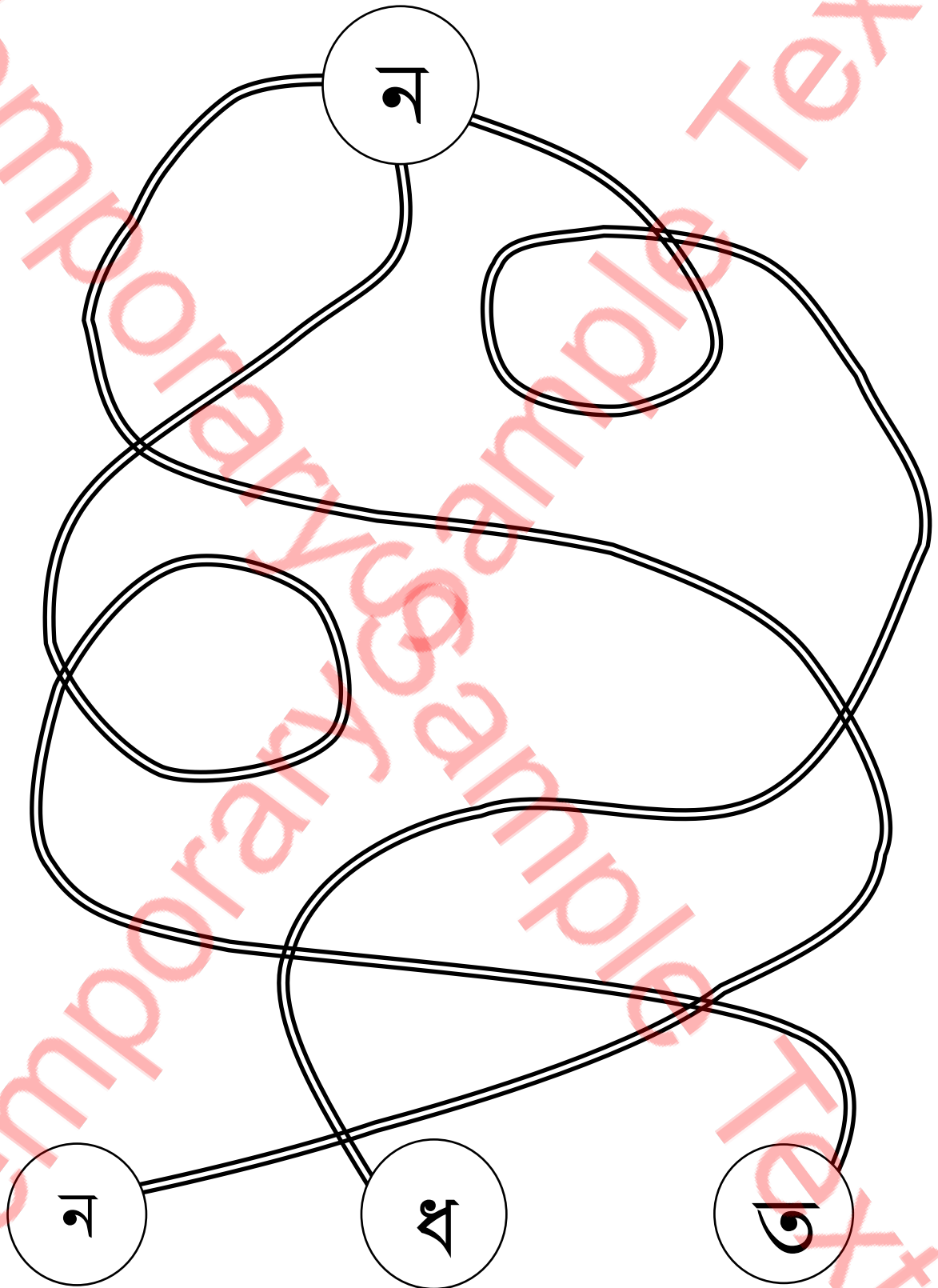

Student Name: \_\_\_\_\_

Verified By: \_\_\_\_\_

Class: \_\_\_\_\_

Date: \_\_\_\_\_



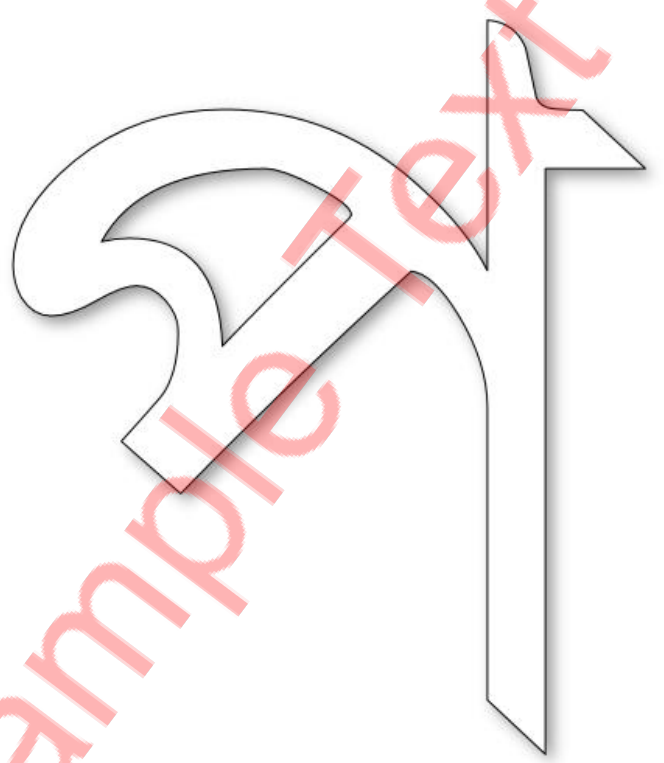
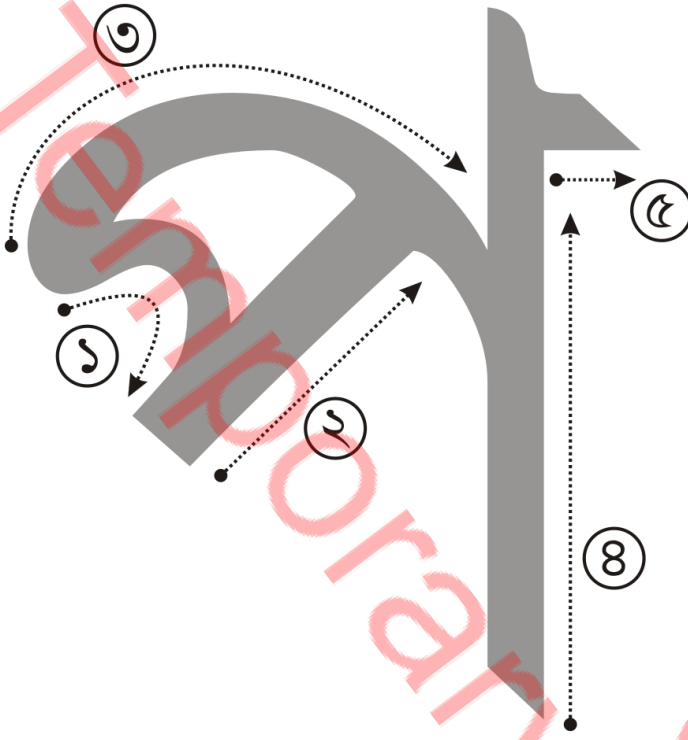

Follow the above steps

Colour it accordingly

ক	খ	গ	ঘ	ঙ	চ	ছ	জ
ঝ	ঞ	ট	ঠ	ড	ঢ	ণ	ত
থ	দ	ধ	ন	প	ফ	ব	ভ
ম	য	ষ	র	ৱ	শ	ষ	স
হ	ক্ষ	ড়	ঢ়	য়	ং	ঃ	ৎ

Student Name: \_\_\_\_\_

Verified By: \_\_\_\_\_

Class: \_\_\_\_\_

Date: \_\_\_\_\_

# Trace It

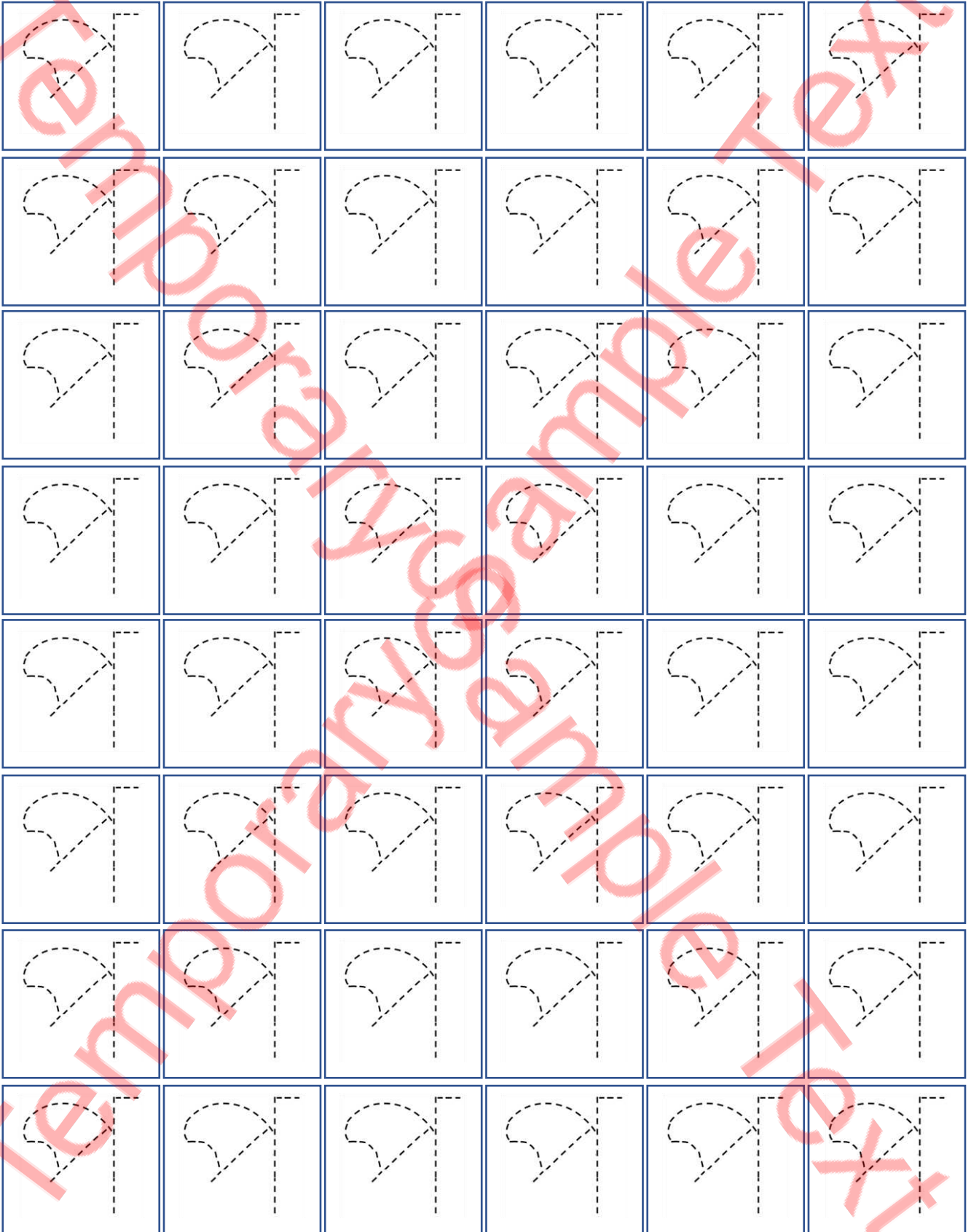

Student Name: \_\_\_\_\_

Verified By: \_\_\_\_\_

Class: \_\_\_\_\_

Date: \_\_\_\_\_

# Trace it

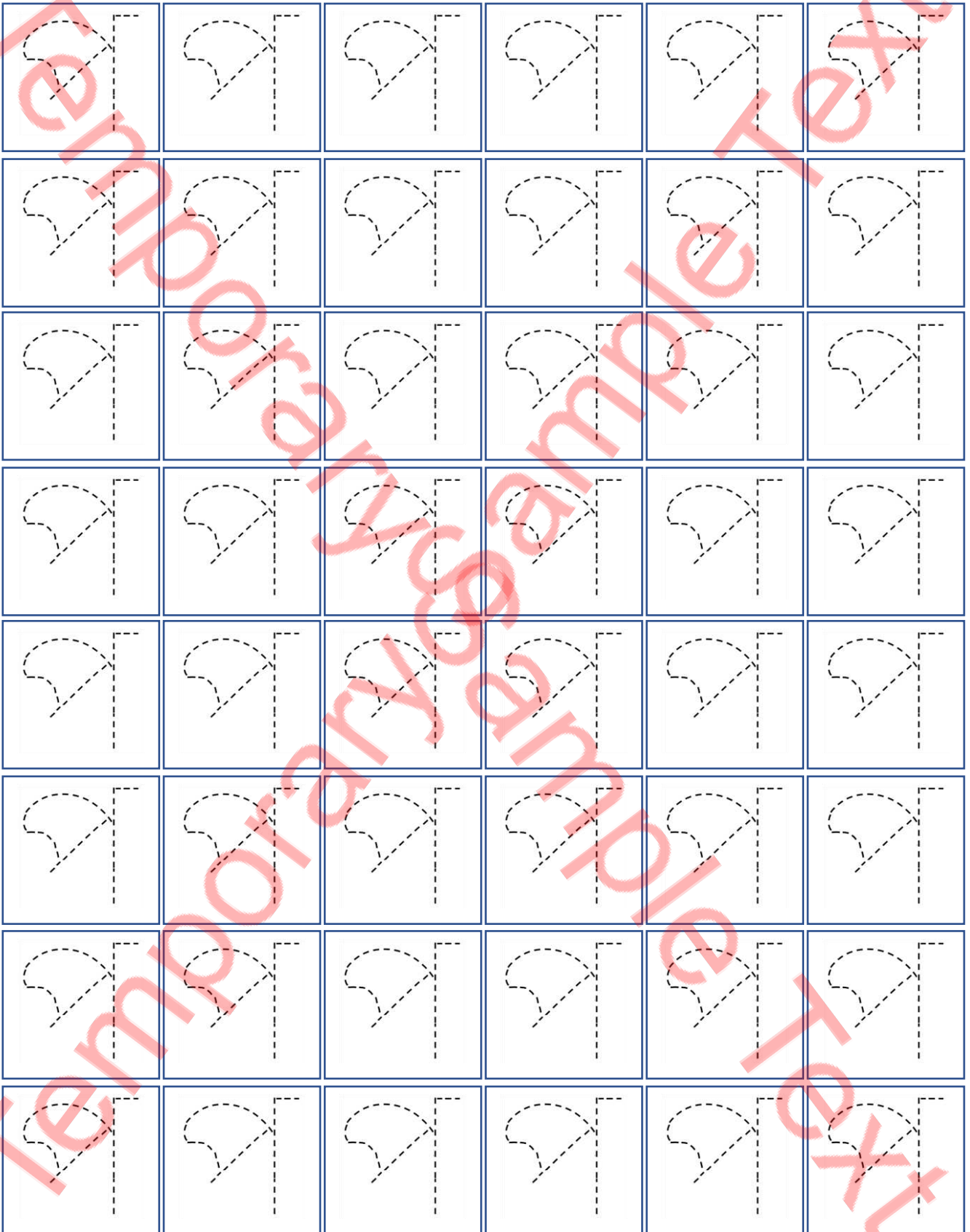

Student Name: \_\_\_\_\_

Verified By: \_\_\_\_\_

Class: \_\_\_\_\_

Date: \_\_\_\_\_

## Write it

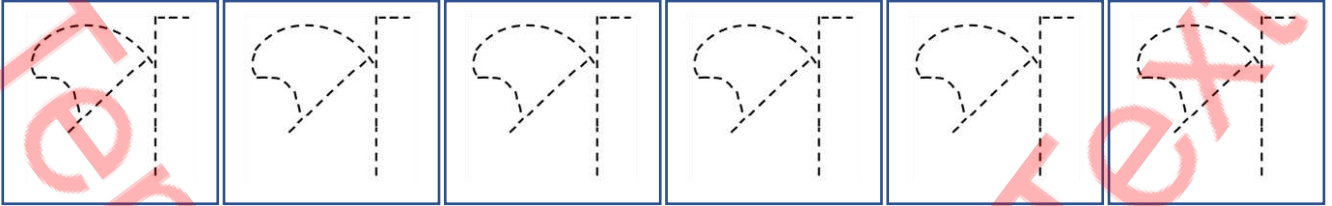

Student Name: \_\_\_\_\_

Verified By: \_\_\_\_\_

Class: \_\_\_\_\_

Date: \_\_\_\_\_

Copy Colour

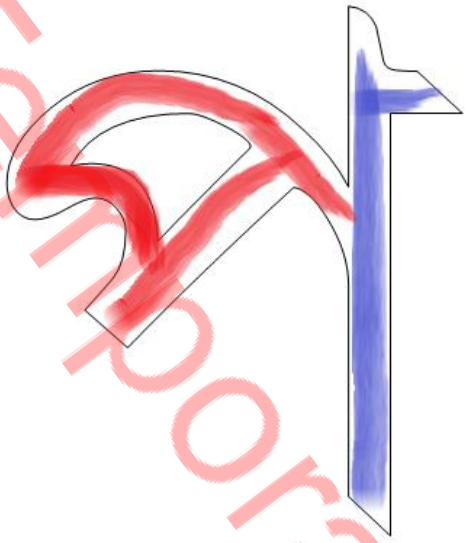

Colour it

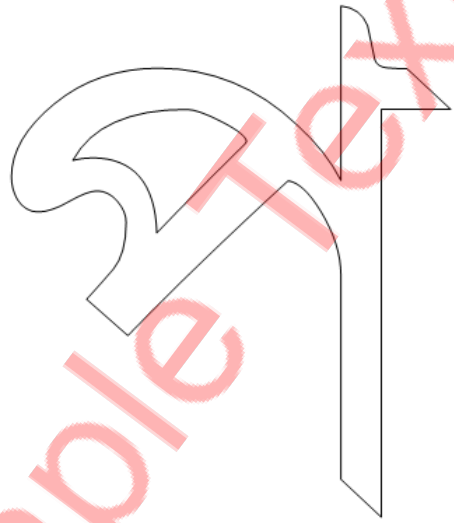

Write it

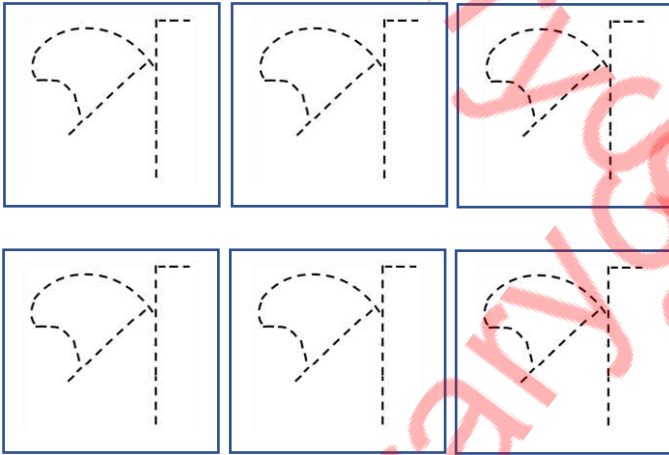

Find it

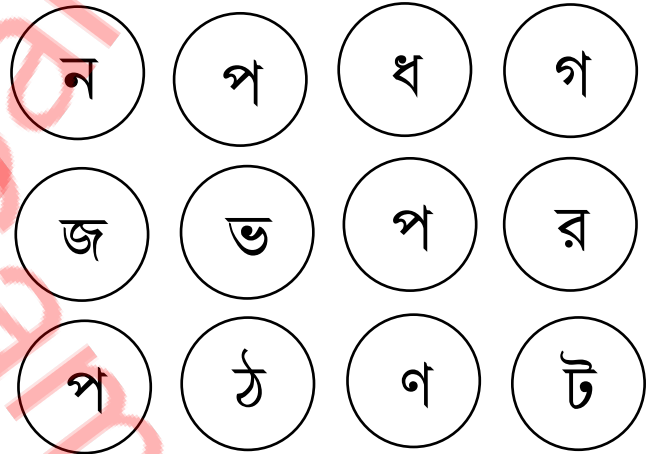

Connect the circle

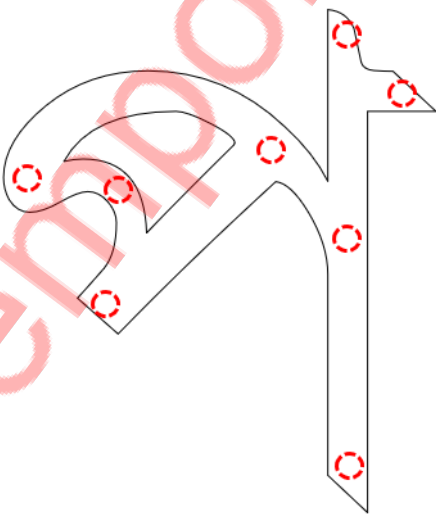

Do it

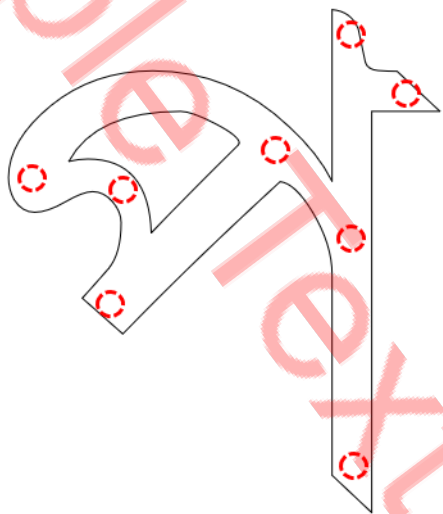

Student Name: \_\_\_\_\_

Verified By: \_\_\_\_\_

Class: \_\_\_\_\_

Date: \_\_\_\_\_

## Pick the Path Find the Correct Alphabet

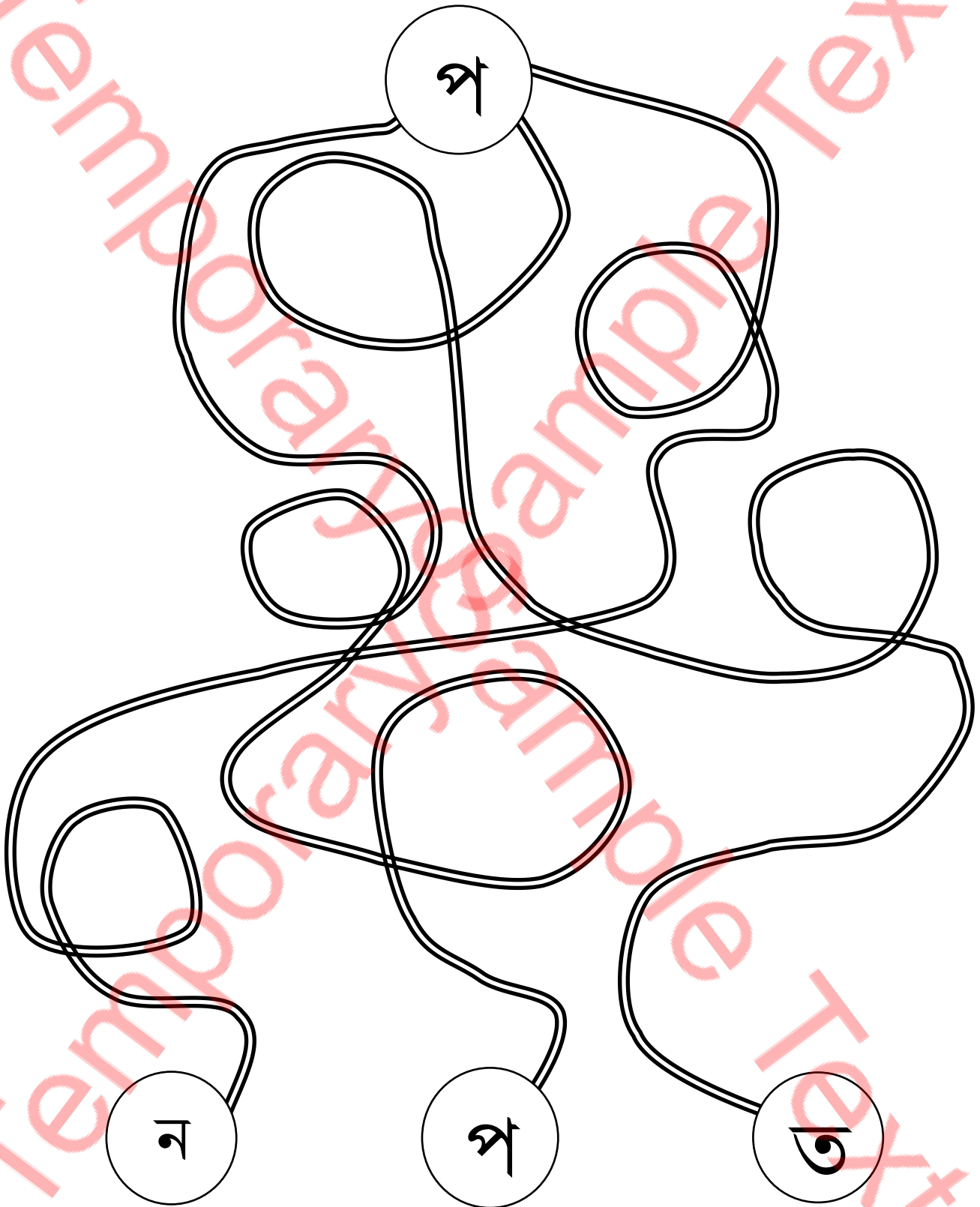

Student Name: \_\_\_\_\_

Verified By: \_\_\_\_\_

Class: \_\_\_\_\_

Date: \_\_\_\_\_



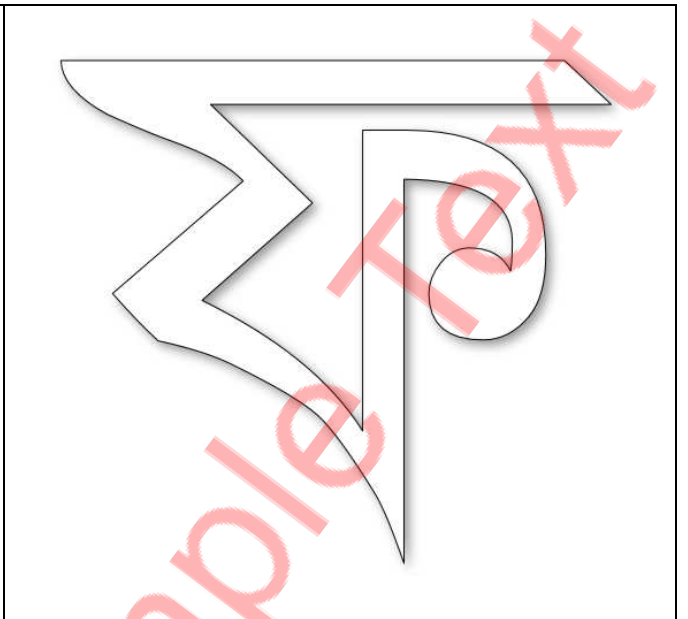
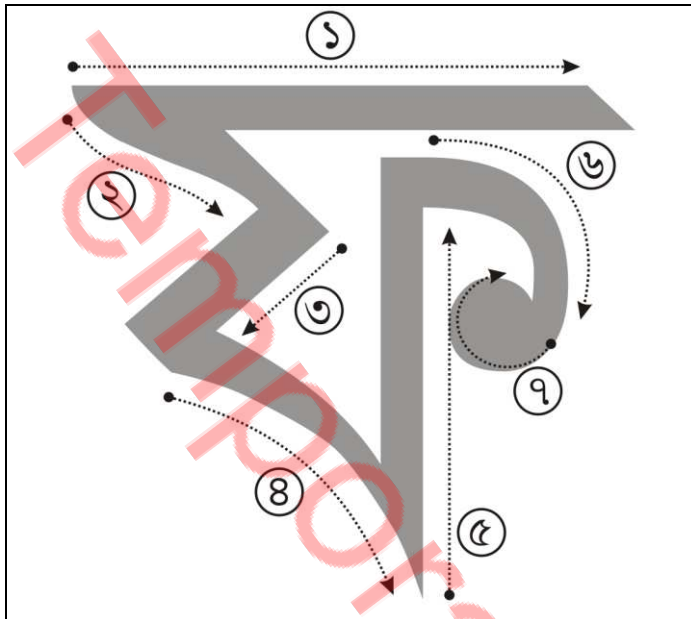

Follow the above steps

Colour it accordingly

ক	খ	গ	ঘ	ঙ	চ	ছ	জ
ঝ	ঞ	ট	ঠ	ড	ঢ	ণ	ত
থ	দ	ধ	ন	প	ফ	ব	ভ
ম	য	র	ল	শ	ষ	স	
ং	ক্ষ	জ্	ড্	য়	ৎ	ঙ	ৎ

Student Name: \_\_\_\_\_

Verified By: \_\_\_\_\_

Class: \_\_\_\_\_

Date: \_\_\_\_\_

## Trace It

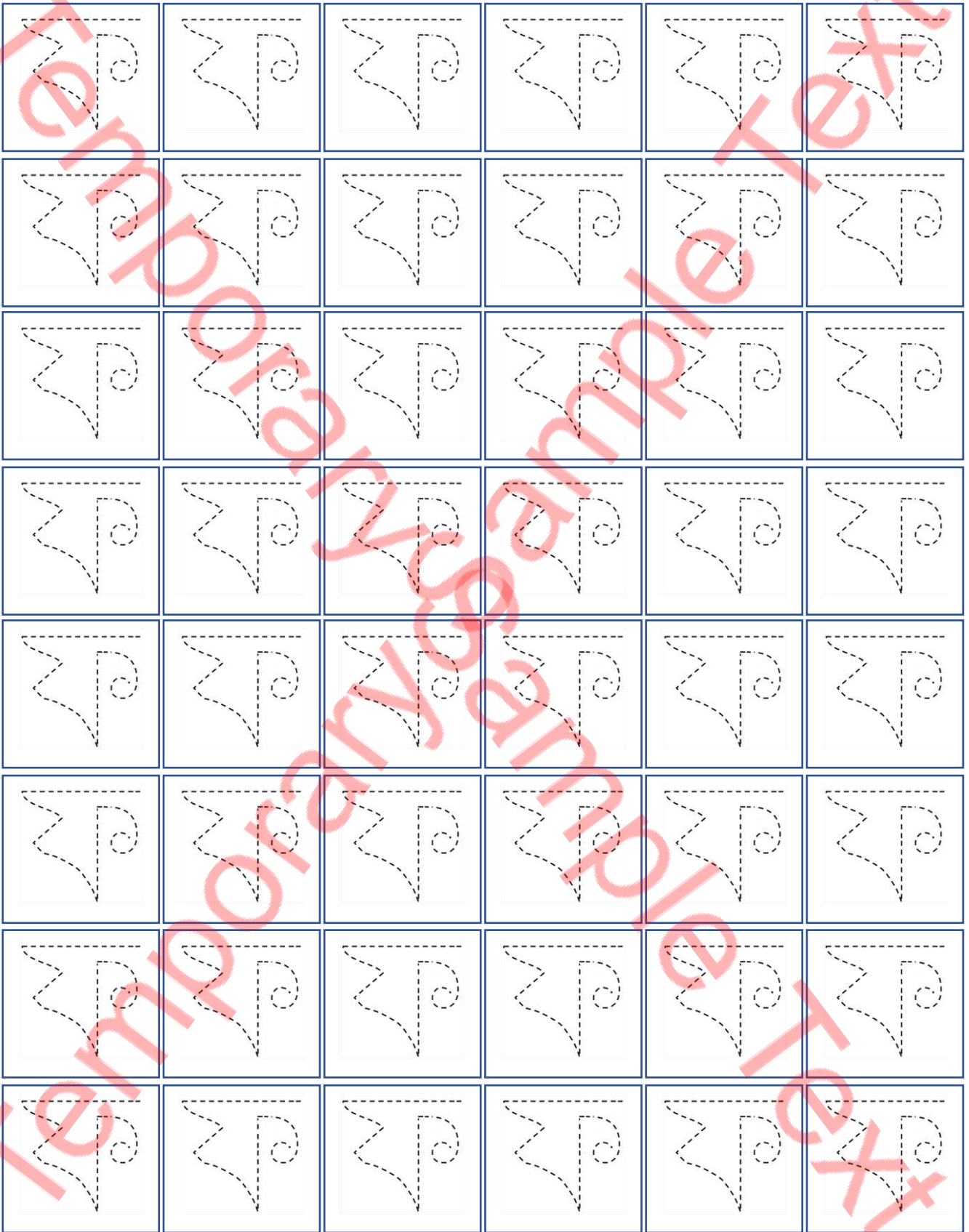

Student Name: \_\_\_\_\_

Verified By: \_\_\_\_\_

Class: \_\_\_\_\_

Date: \_\_\_\_\_

# Trace it

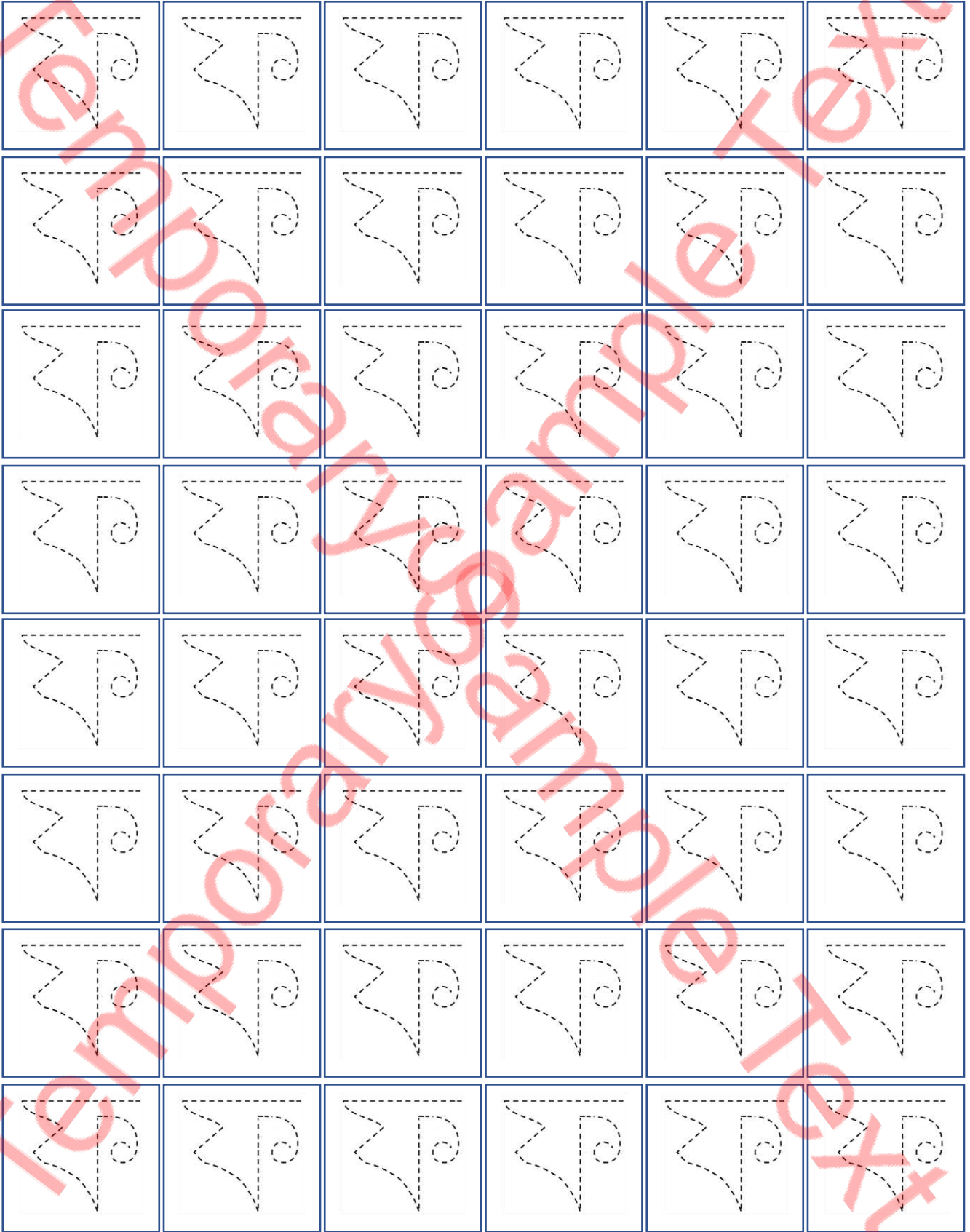

Student Name: \_\_\_\_\_

Verified By: \_\_\_\_\_

Class: \_\_\_\_\_

Date: \_\_\_\_\_

# Write it

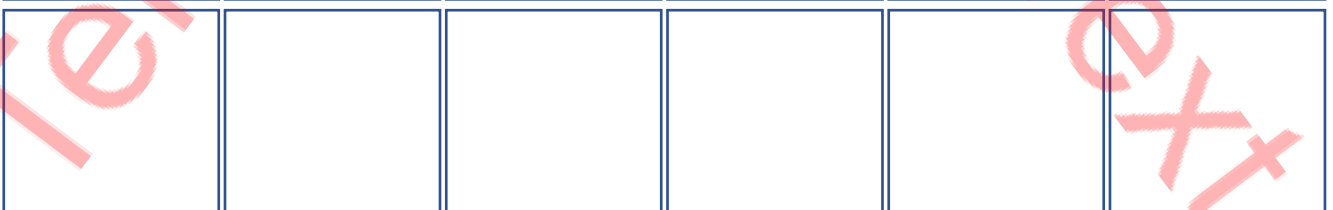
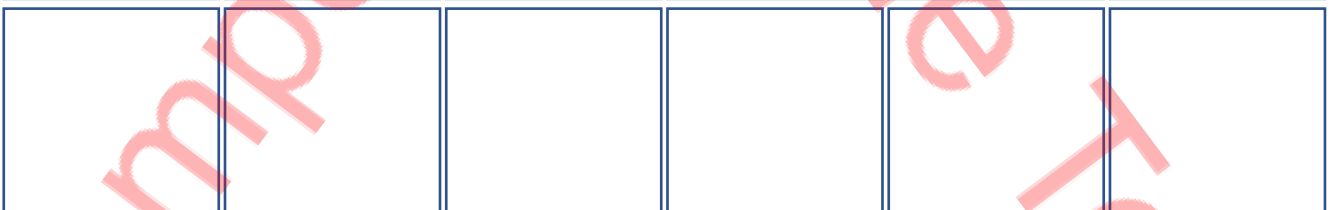
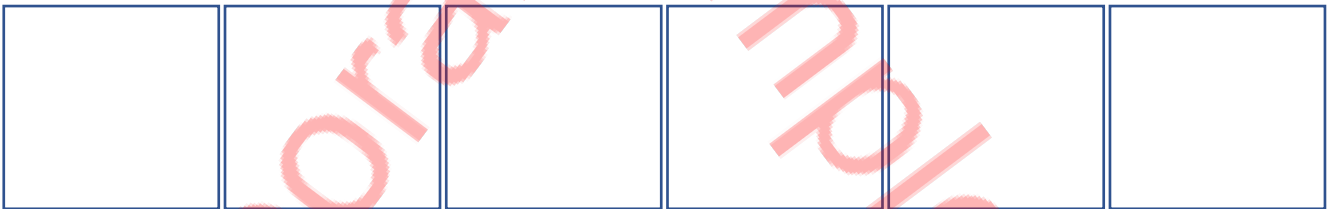
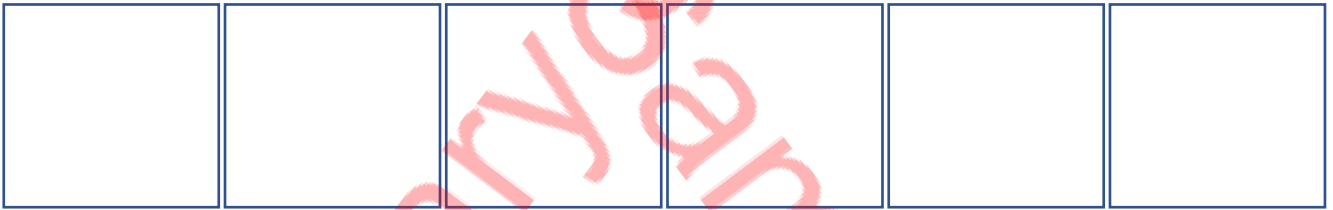
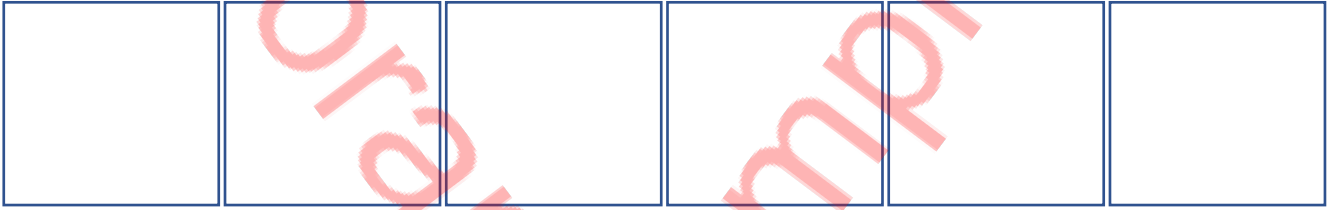
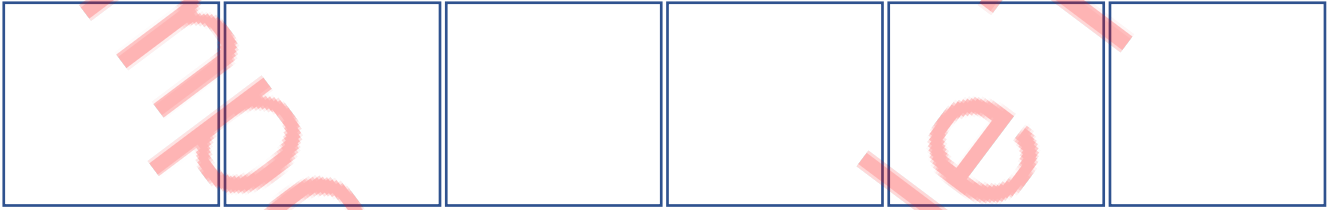
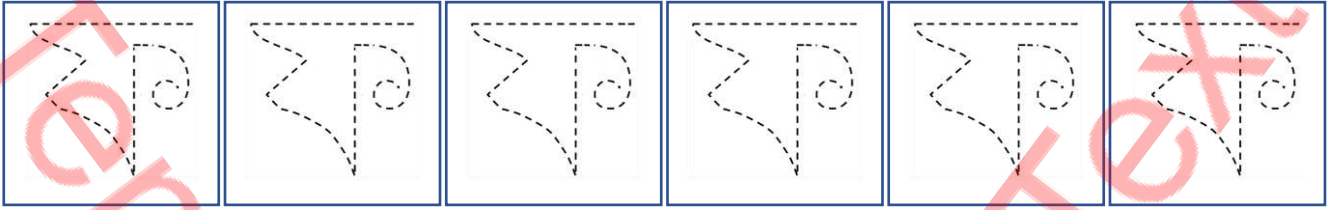

Student Name: \_\_\_\_\_

Verified By: \_\_\_\_\_

Class: \_\_\_\_\_

Date: \_\_\_\_\_

Copy Colour



Colour it

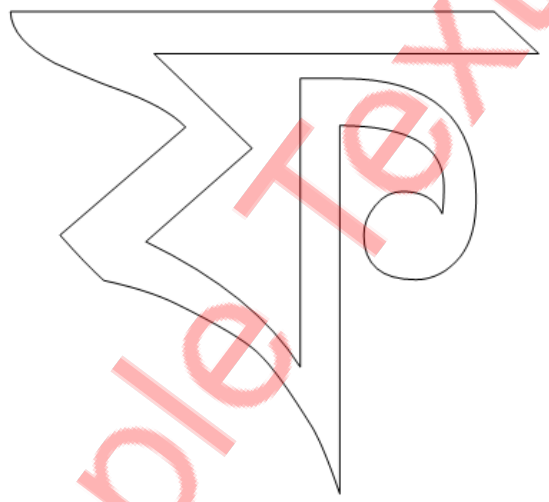

Write it

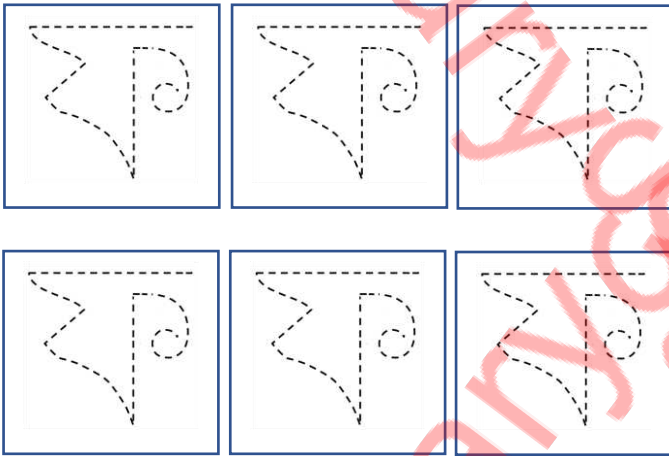

Find it

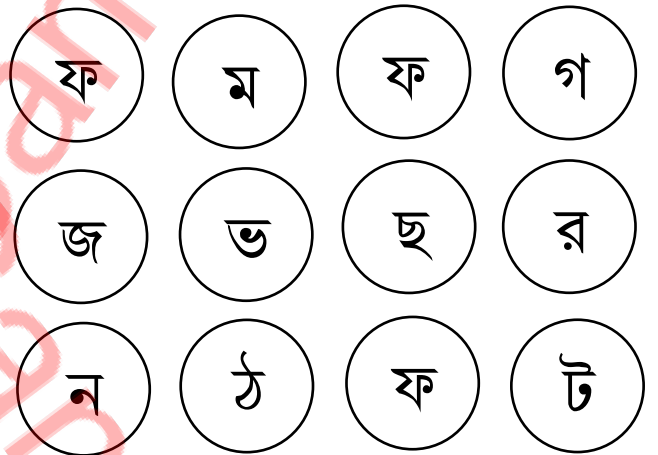

Connect the circle

Do it

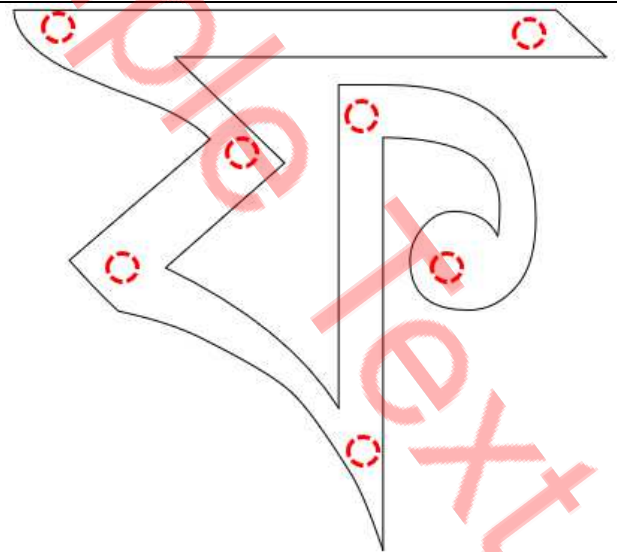
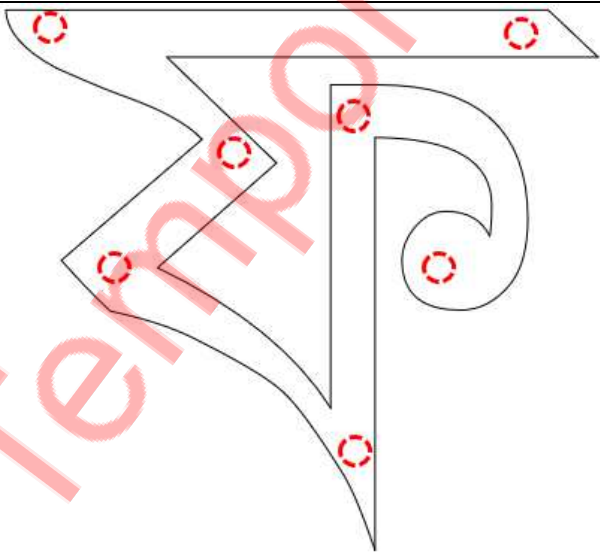

Student Name: \_\_\_\_\_

Verified By: \_\_\_\_\_

Class: \_\_\_\_\_

Date: \_\_\_\_\_

Pick the Path Find the Correct Alphabet

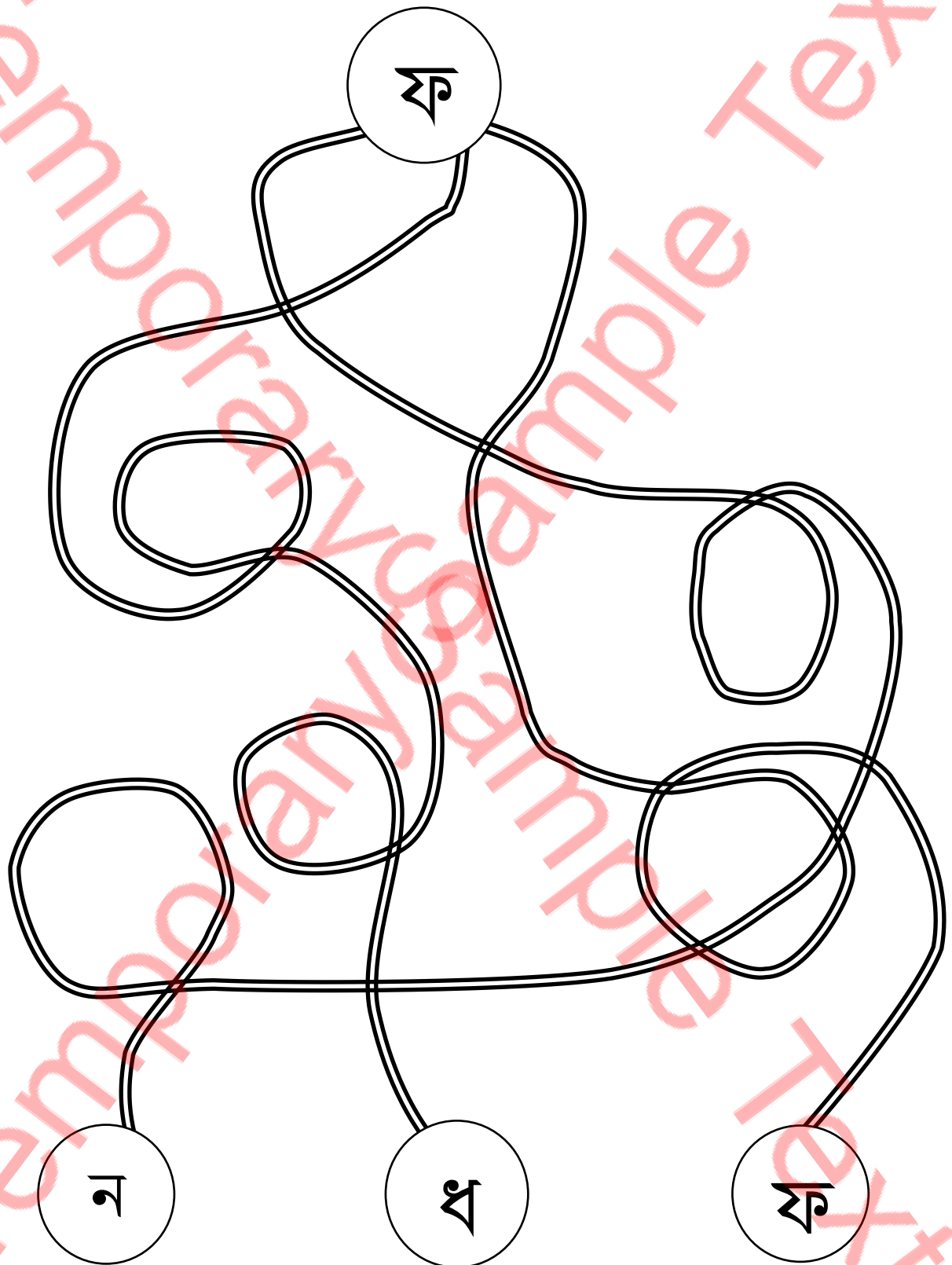

Student Name: \_\_\_\_\_

Verified By: \_\_\_\_\_

Class: \_\_\_\_\_

Date: \_\_\_\_\_



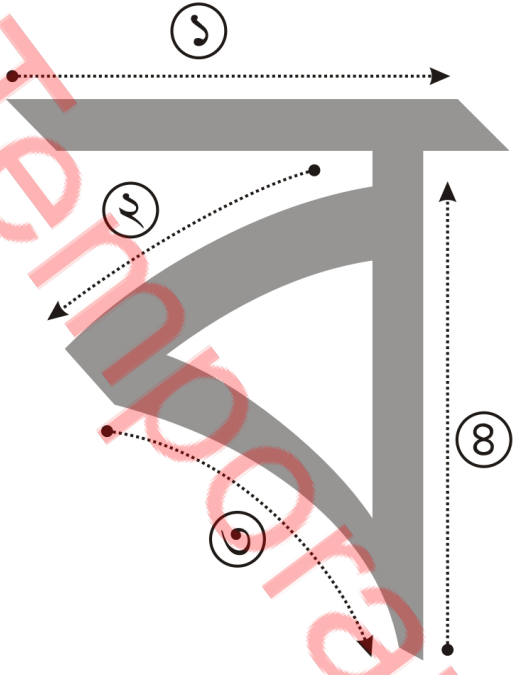

Follow the above steps

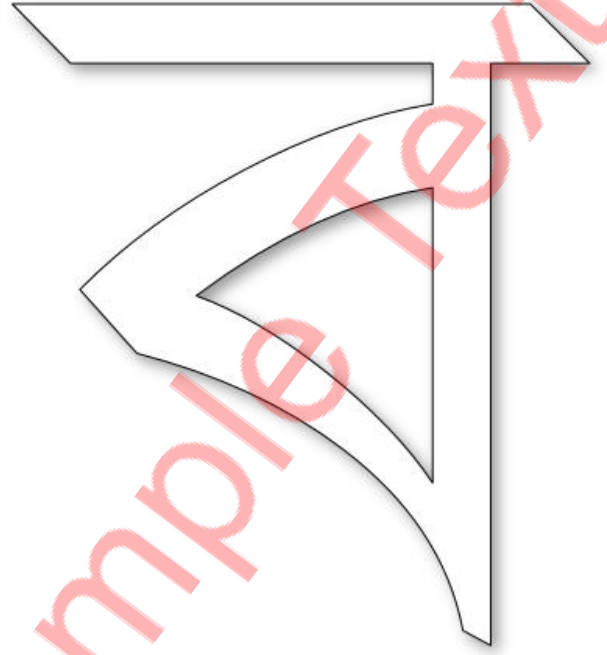

Colour it accordingly

ক	খ	গ	ঘ	ঙ	চ	ছ	জ
ঝ	ঞ	ট	ঠ	ড	ঢ	ণ	ত
থ	দ	ধ	ন	প	ফ	ব	ভ
ম	য	র	ল	শ	ষ	ষ	স
হ	ক্ষ	ড়	ঢ়	য়	ং	ঃ	ঁ

Student Name: \_\_\_\_\_

Verified By: \_\_\_\_\_

Class: \_\_\_\_\_

Date: \_\_\_\_\_

# Trace It

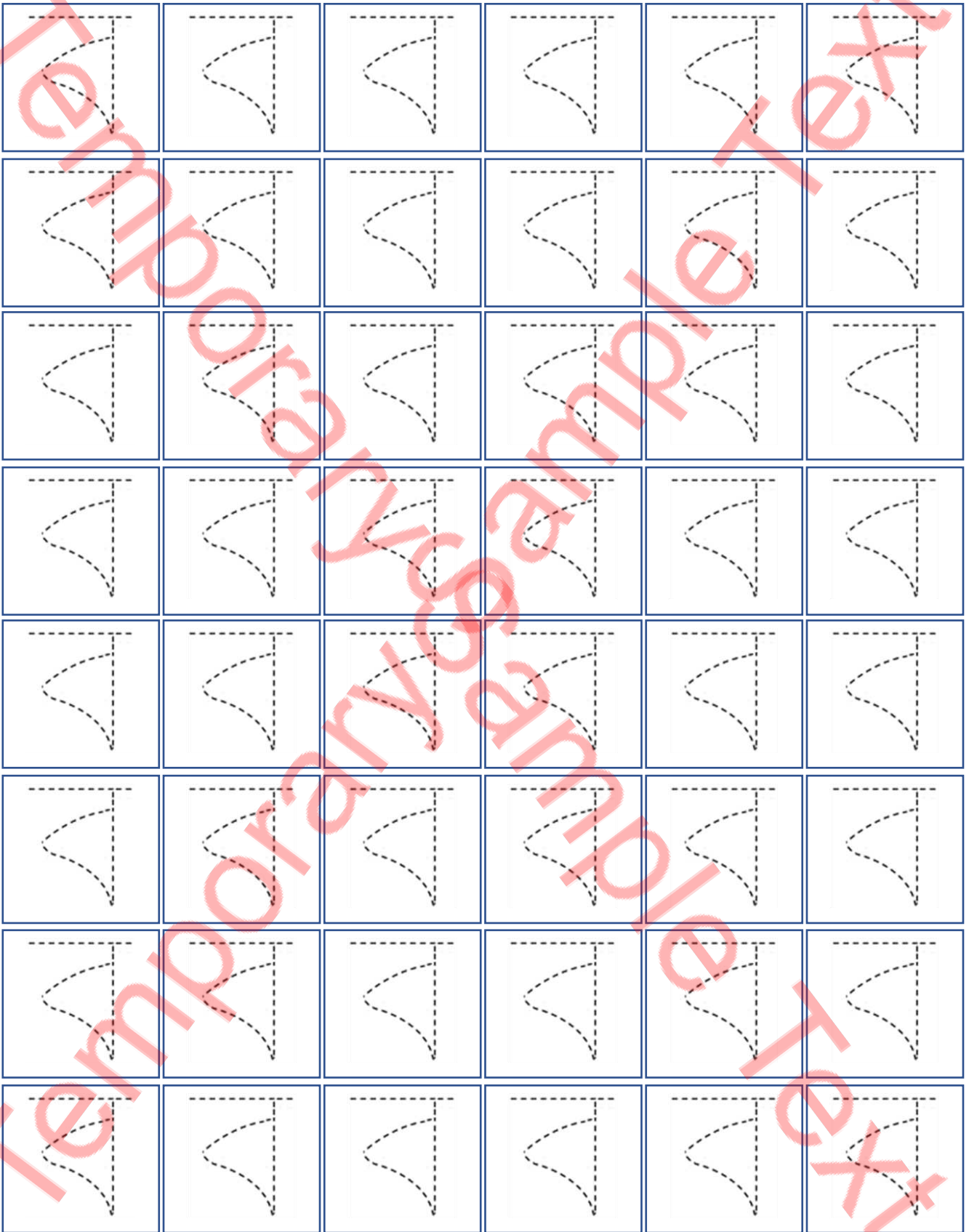

Student Name: \_\_\_\_\_

Verified By: \_\_\_\_\_

Class: \_\_\_\_\_

Date: \_\_\_\_\_

# Trace it

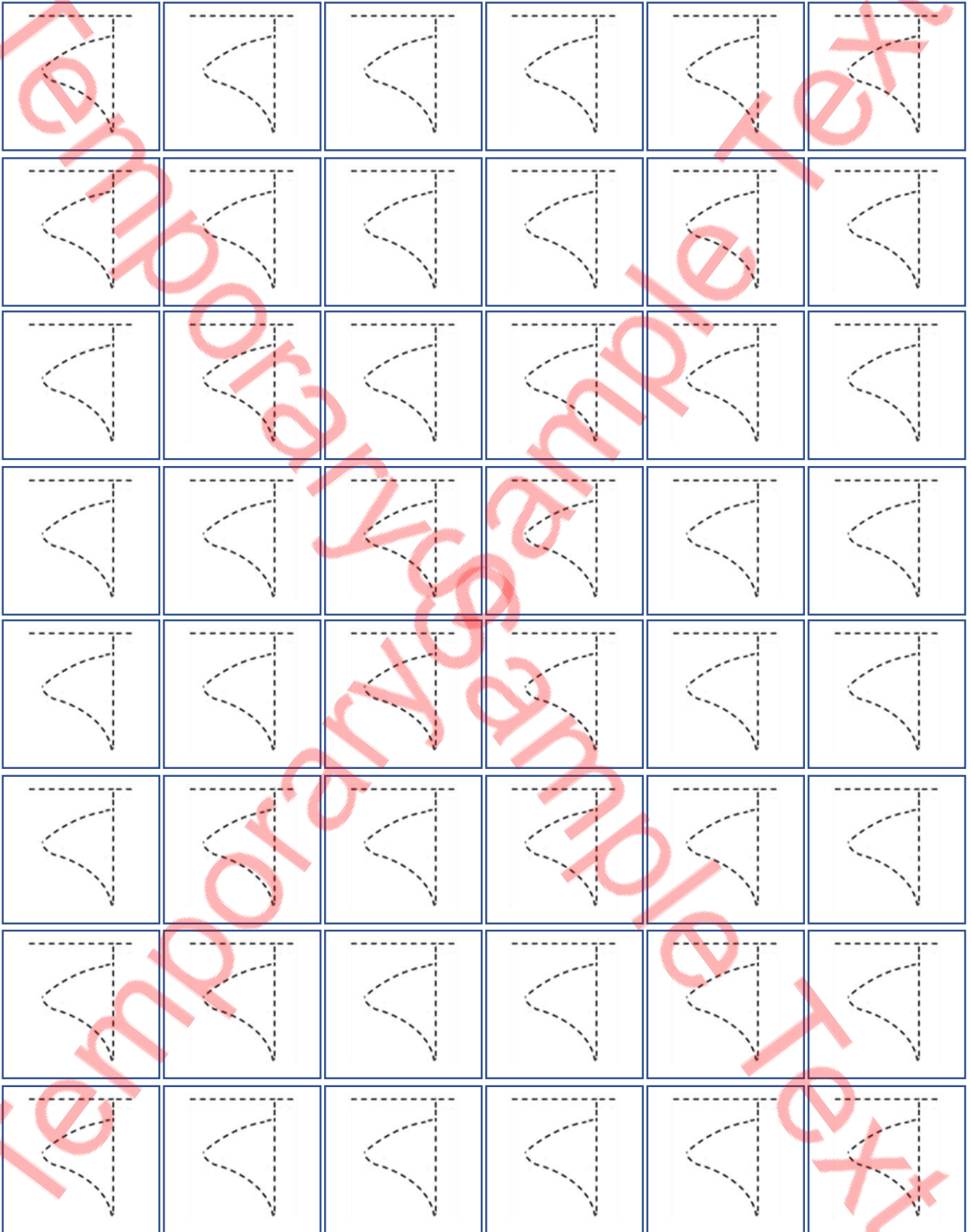

Student Name: \_\_\_\_\_

Verified By: \_\_\_\_\_

Class: \_\_\_\_\_

Date: \_\_\_\_\_

Write it

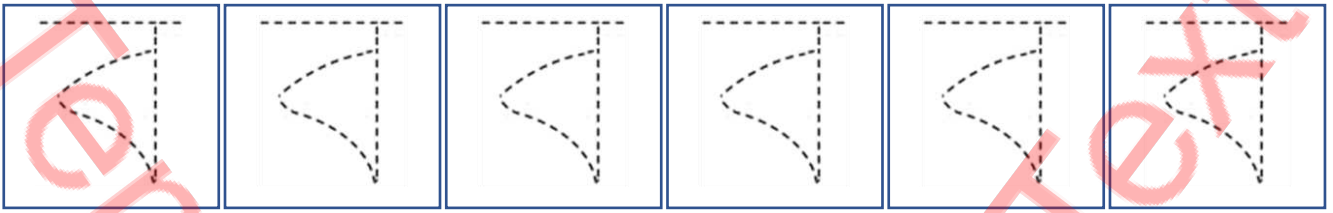



Student Name: \_\_\_\_\_

Verified By: \_\_\_\_\_

Class: \_\_\_\_\_

Date: \_\_\_\_\_

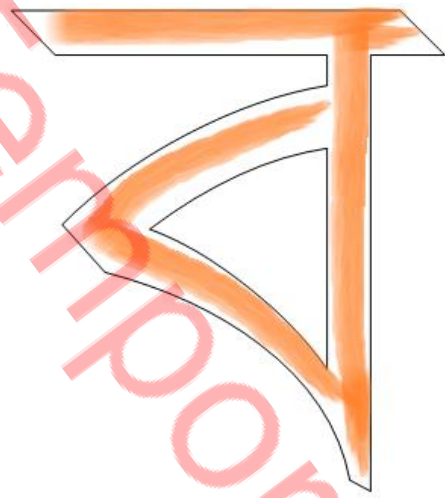
Copy Colour



Colour it

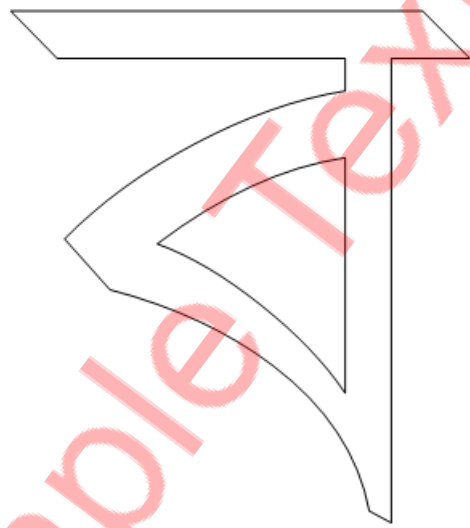

Write it

Find it

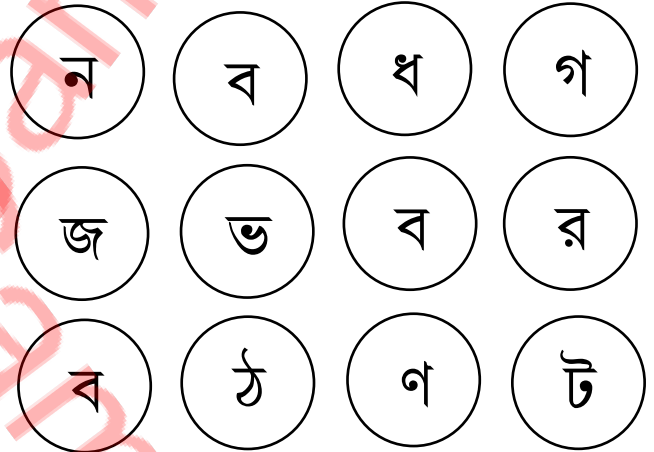
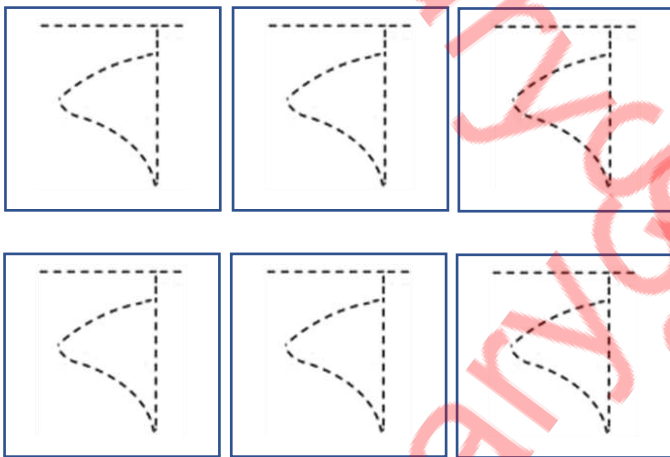

Connect the circle

Do it

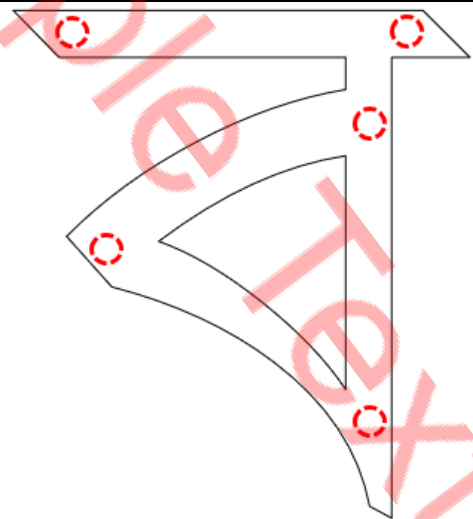
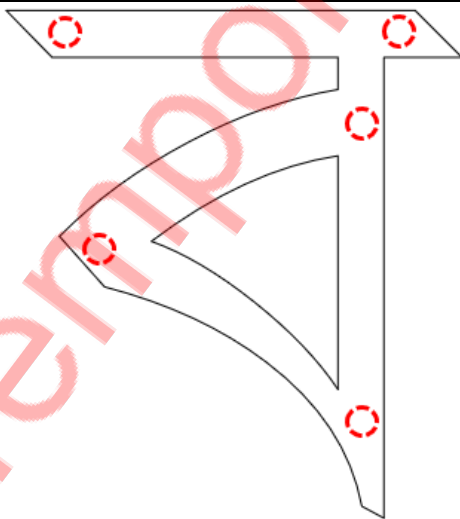

Student Name: \_\_\_\_\_

Verified By: \_\_\_\_\_

Class: \_\_\_\_\_

Date: \_\_\_\_\_

# Pick the Path Find the Correct Alphabet

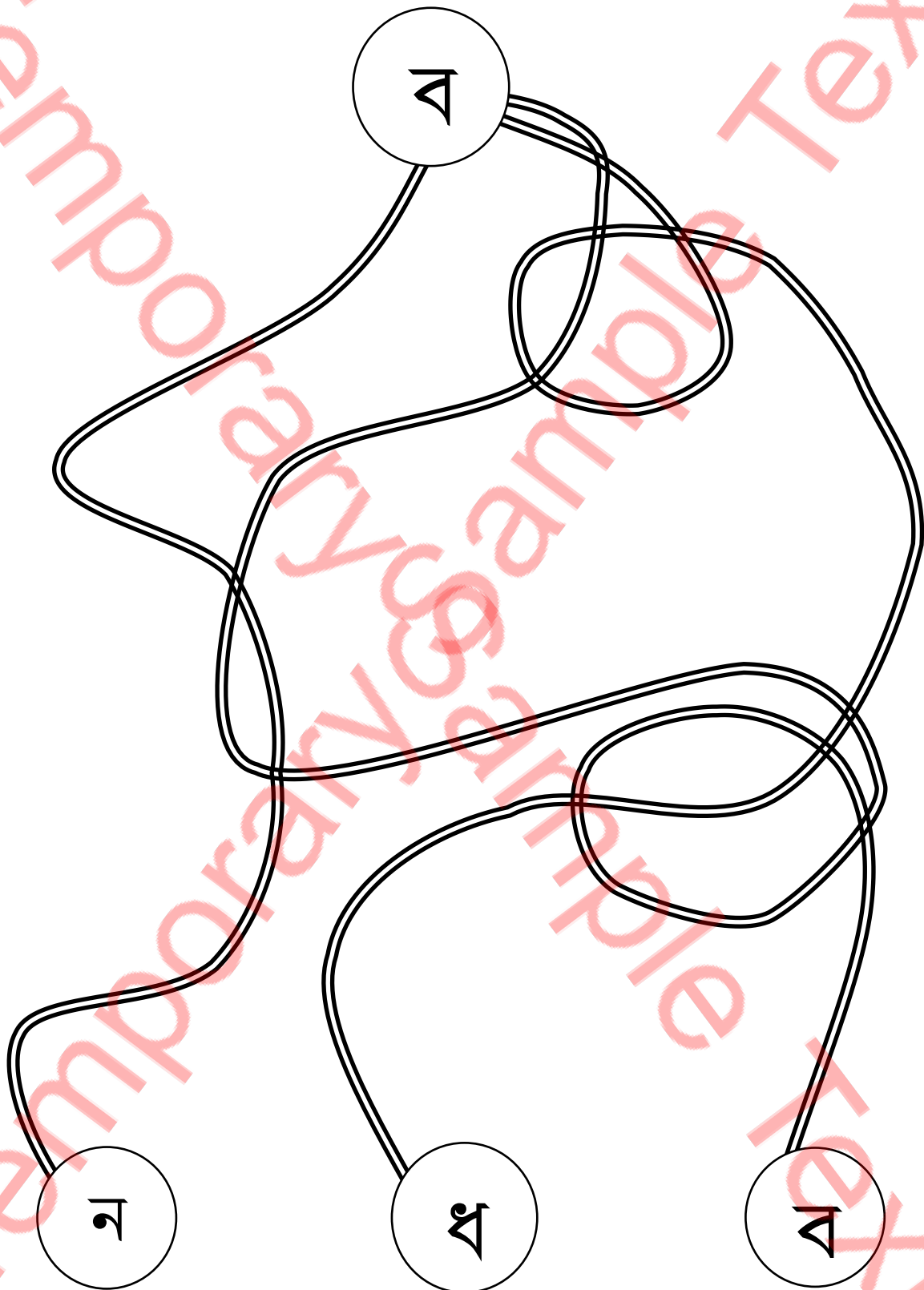

Student Name: \_\_\_\_\_

Verified By: \_\_\_\_\_

Class: \_\_\_\_\_

Date: \_\_\_\_\_



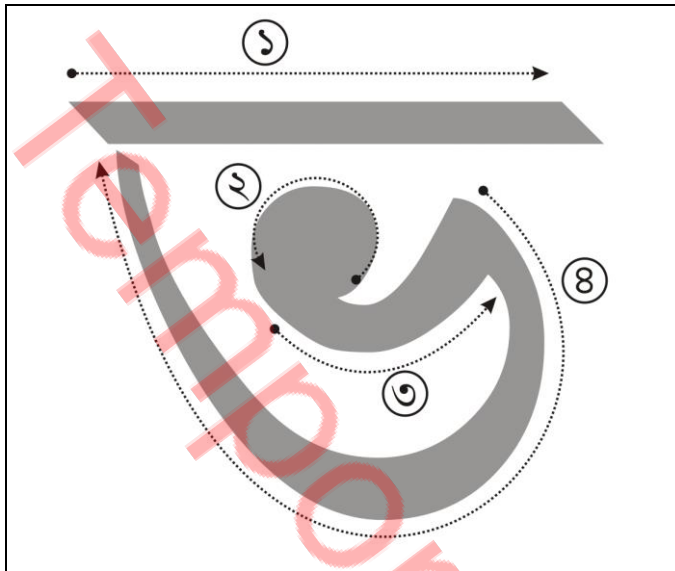

Follow the above steps

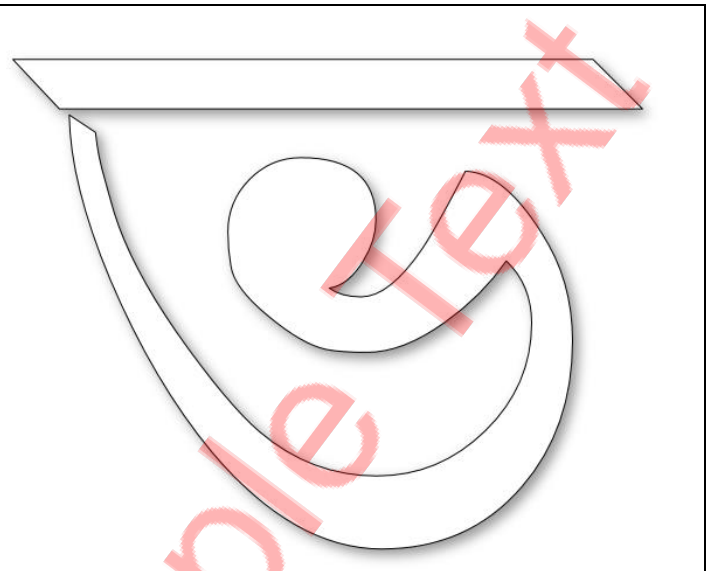

Colour it accordingly

ক	খ	গ	ঘ	ঙ	চ	ছ	জ
ঝ	ঞ	ট	ঠ	ড	ঢ	ণ	ত
থ	দ	ধ	ন	প	ফ	ব	ভ
ম	য	ষ	প্র	র	শ	ষ	স
হ	ক্ষ	ড়	ড়	য়	ং	ঃ	়

Student Name: \_\_\_\_\_

Verified By: \_\_\_\_\_

Class: \_\_\_\_\_

Date: \_\_\_\_\_

## Trace It



Student Name: \_\_\_\_\_

Verified By: \_\_\_\_\_

Class: \_\_\_\_\_

Date: \_\_\_\_\_

# Trace it



Student Name: \_\_\_\_\_

Verified By: \_\_\_\_\_

Class: \_\_\_\_\_

Date: \_\_\_\_\_

## Write it

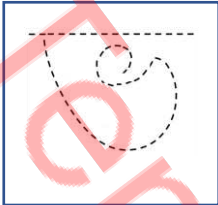
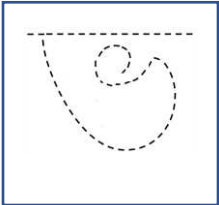
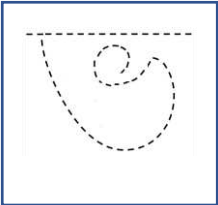
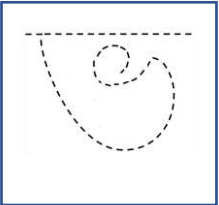
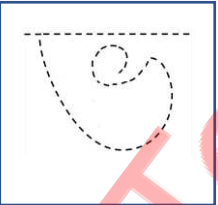
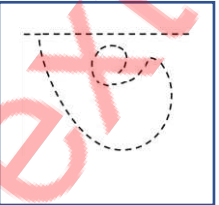
Student Name: \_\_\_\_\_

Verified By: \_\_\_\_\_

Class: \_\_\_\_\_

Date: \_\_\_\_\_

Copy Colour

Colour it

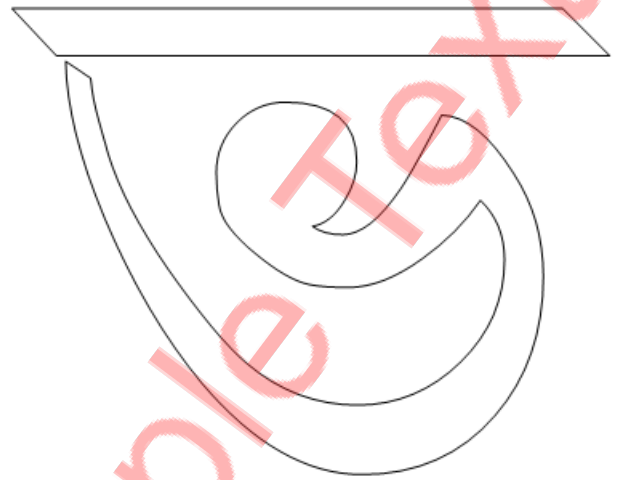

Write it

Find it

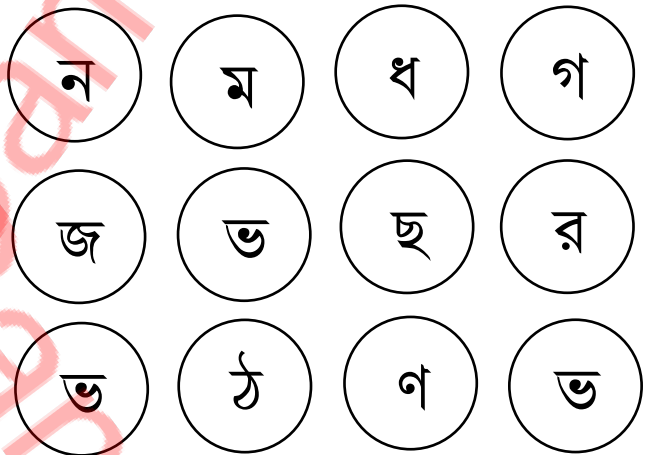
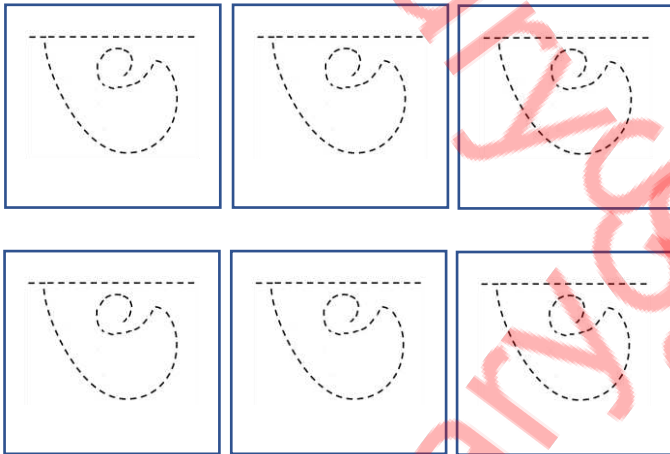

Connect the circle

Do it

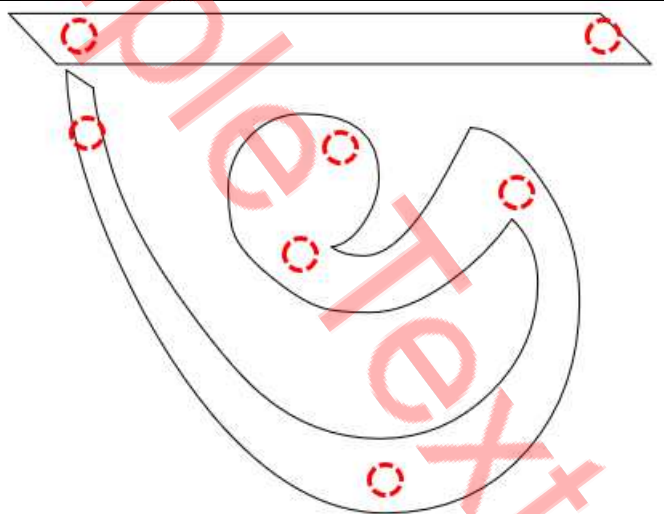
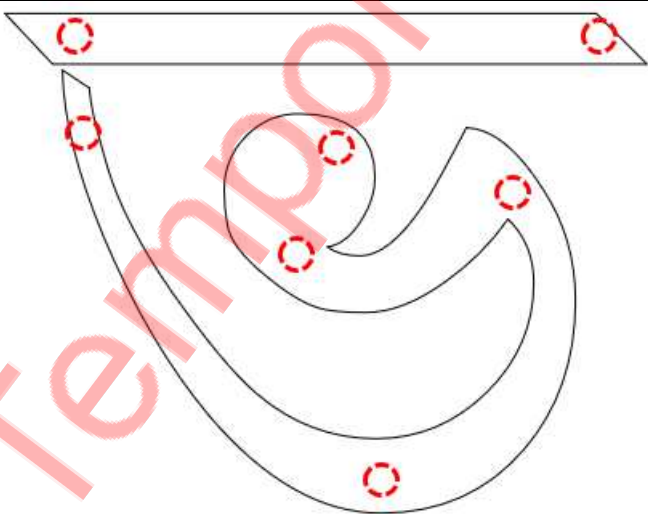

Student Name: \_\_\_\_\_

Verified By: \_\_\_\_\_

Class: \_\_\_\_\_

Date: \_\_\_\_\_

# Pick the Path Find the Correct Alphabet

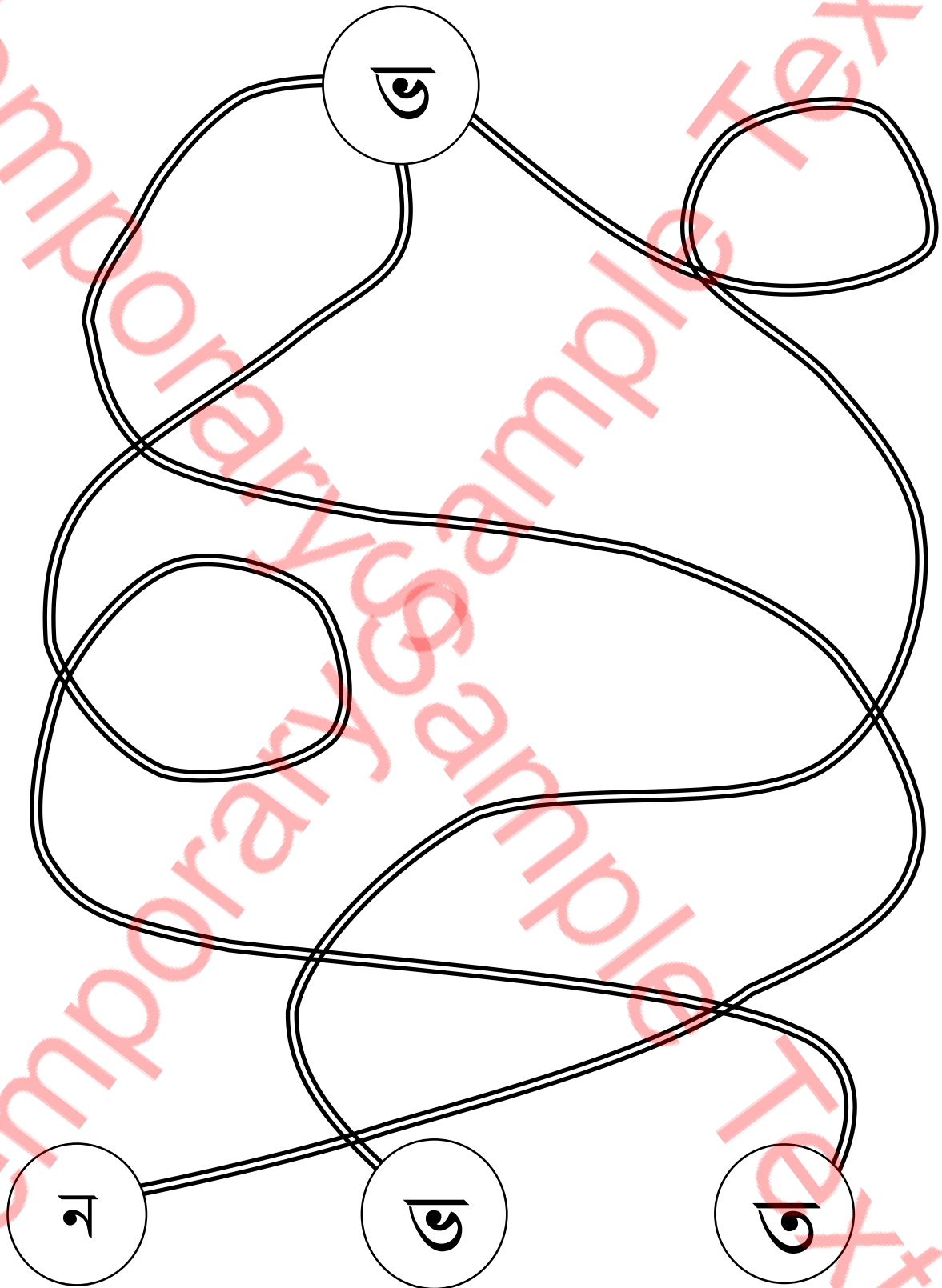

Student Name: \_\_\_\_\_

Verified By: \_\_\_\_\_

Class: \_\_\_\_\_

Date: \_\_\_\_\_



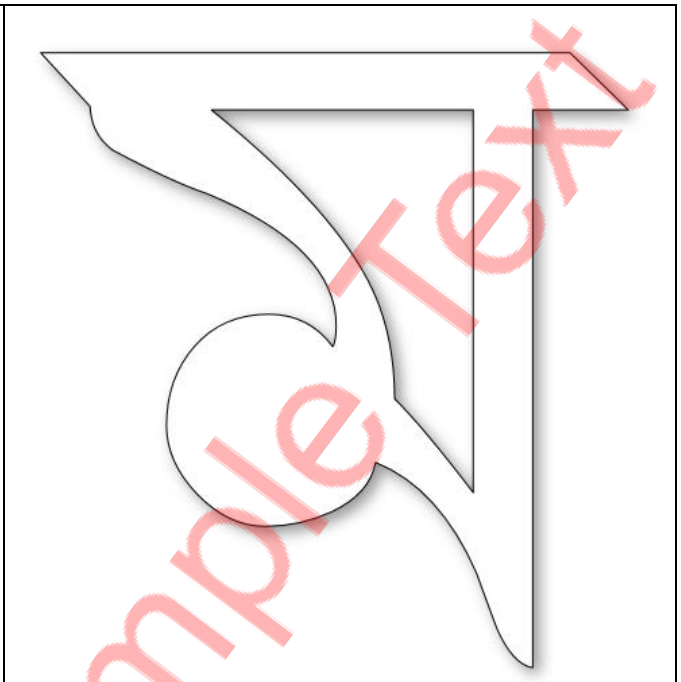
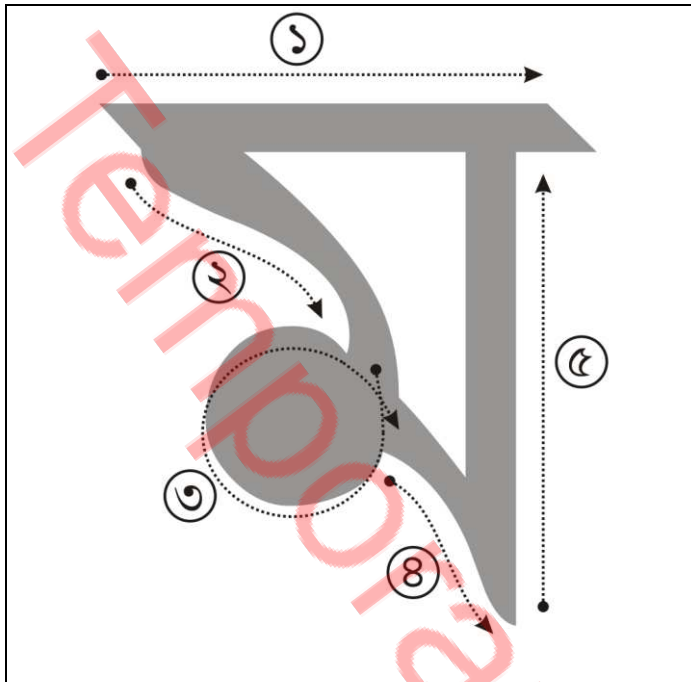

Follow the above steps

Colour it accordingly

ক	খ	গ	ঘ	ঙ	চ	ছ	জ
ঝ	ঞ	ট	ঠ	ড	ঢ	ণ	ত
থ	দ	ধ	ন	প	ফ	ব	ভ
ম	য	র	ল	শ	ষ	স	
হ	ক্ষ	ড়	ড়	য়	ং	ঃ	ঁ

Student Name: \_\_\_\_\_

Verified By: \_\_\_\_\_

Class: \_\_\_\_\_

Date: \_\_\_\_\_

## Trace It



Student Name: \_\_\_\_\_

Verified By: \_\_\_\_\_

Class: \_\_\_\_\_

Date: \_\_\_\_\_

## Trace it



Student Name: \_\_\_\_\_

Verified By: \_\_\_\_\_

Class: \_\_\_\_\_

Date: \_\_\_\_\_

Write it

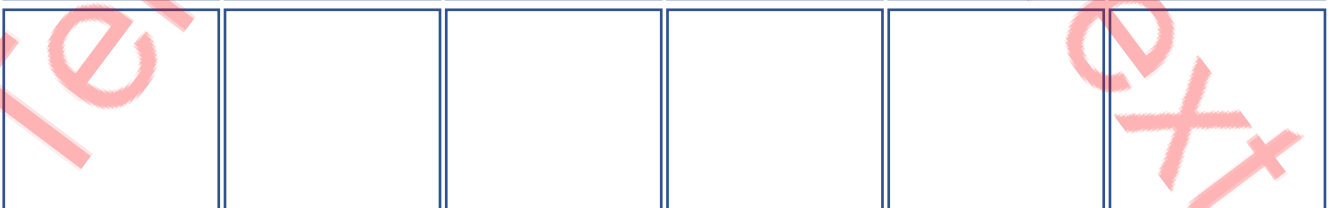
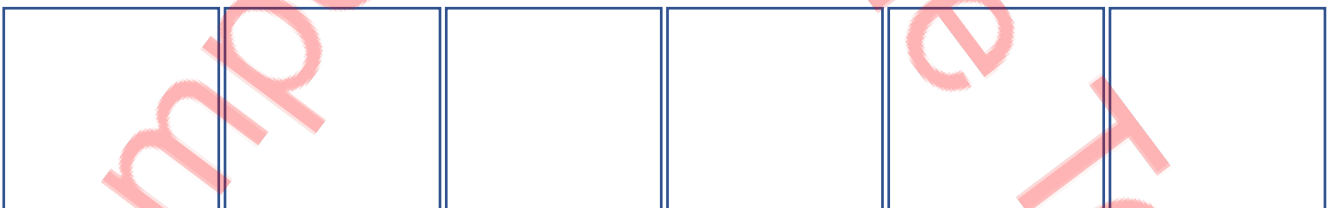
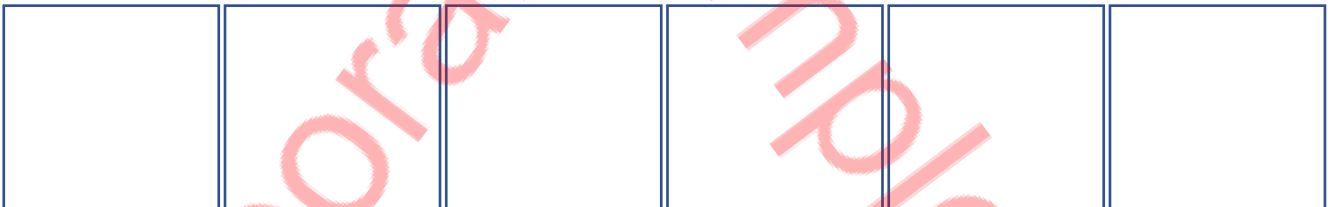
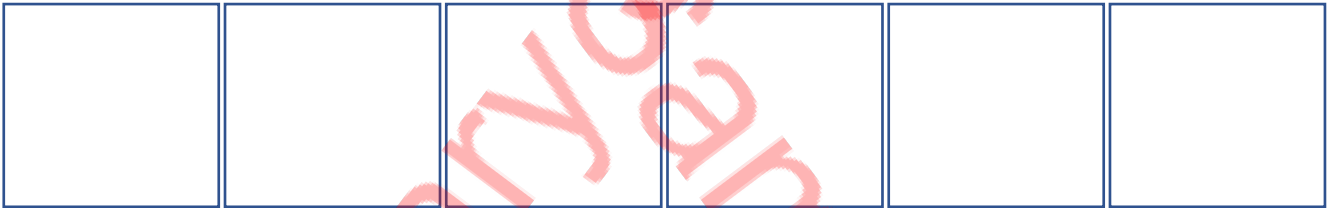
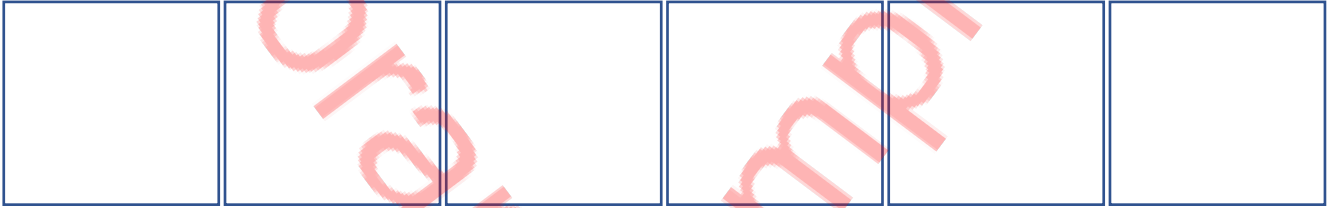
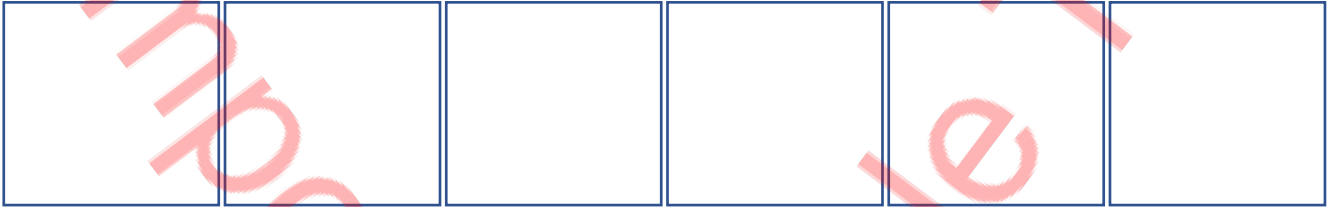
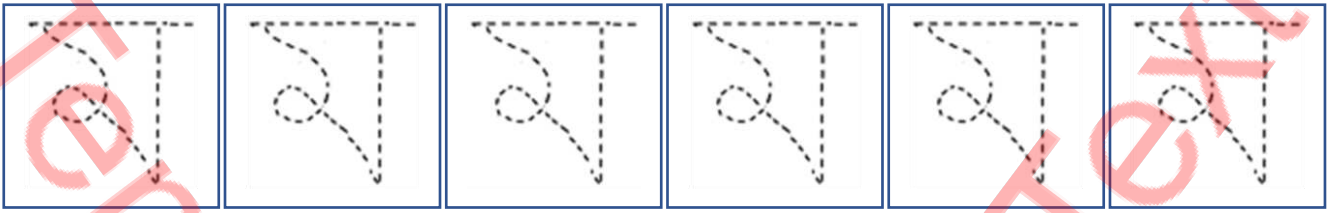

Student Name: \_\_\_\_\_

Verified By: \_\_\_\_\_

Class: \_\_\_\_\_

Date: \_\_\_\_\_

Copy Colour

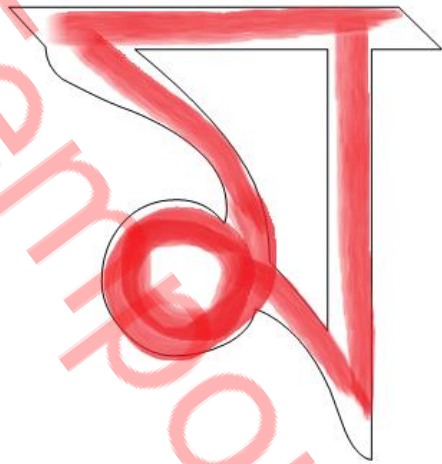

Colour it

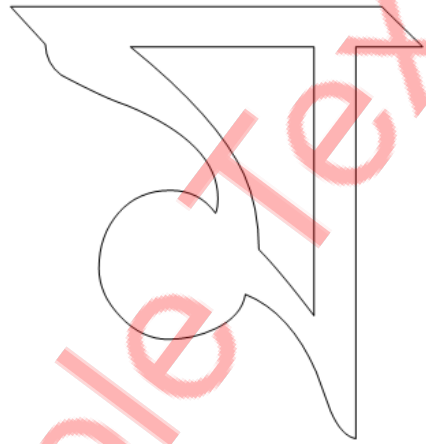

Write it

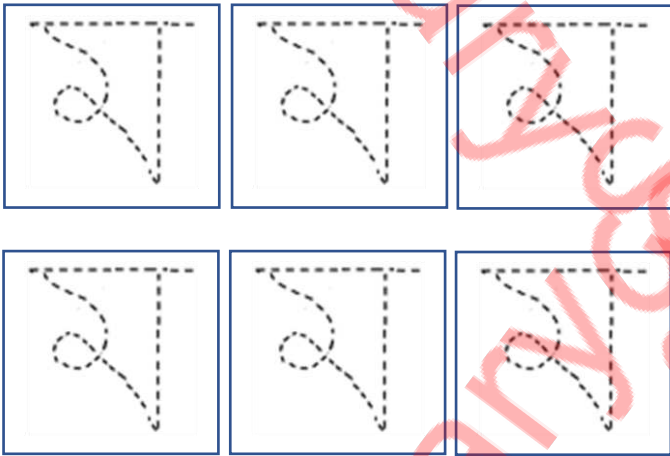

Find it

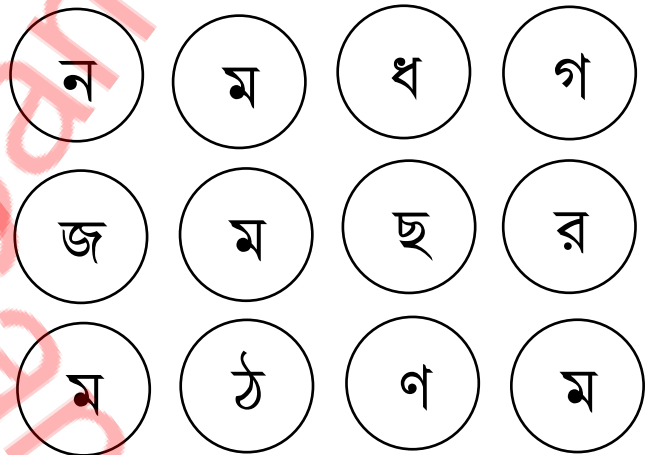

Connect the circle

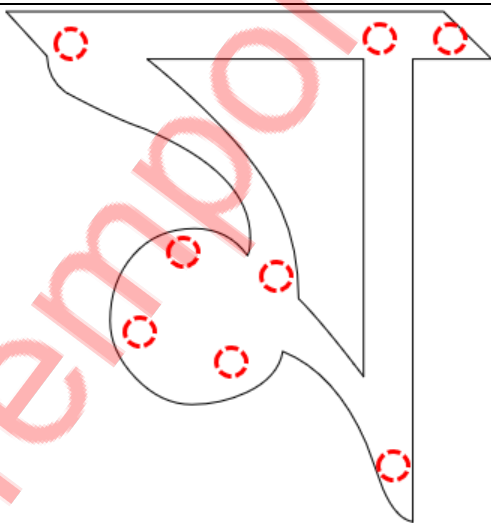

Do it

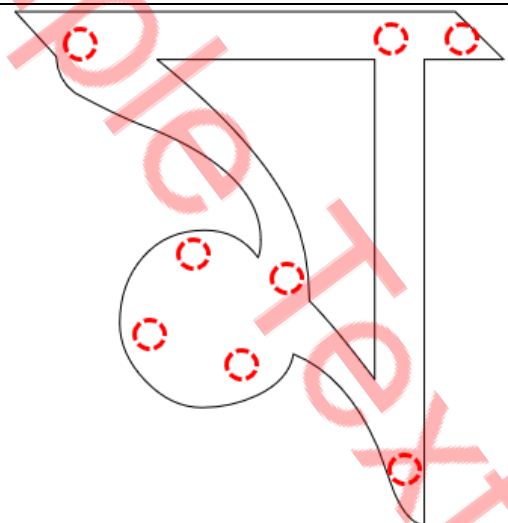

Student Name: \_\_\_\_\_

Verified By: \_\_\_\_\_

Class: \_\_\_\_\_

Date: \_\_\_\_\_

## Pick the Path Find the Correct Alphabet

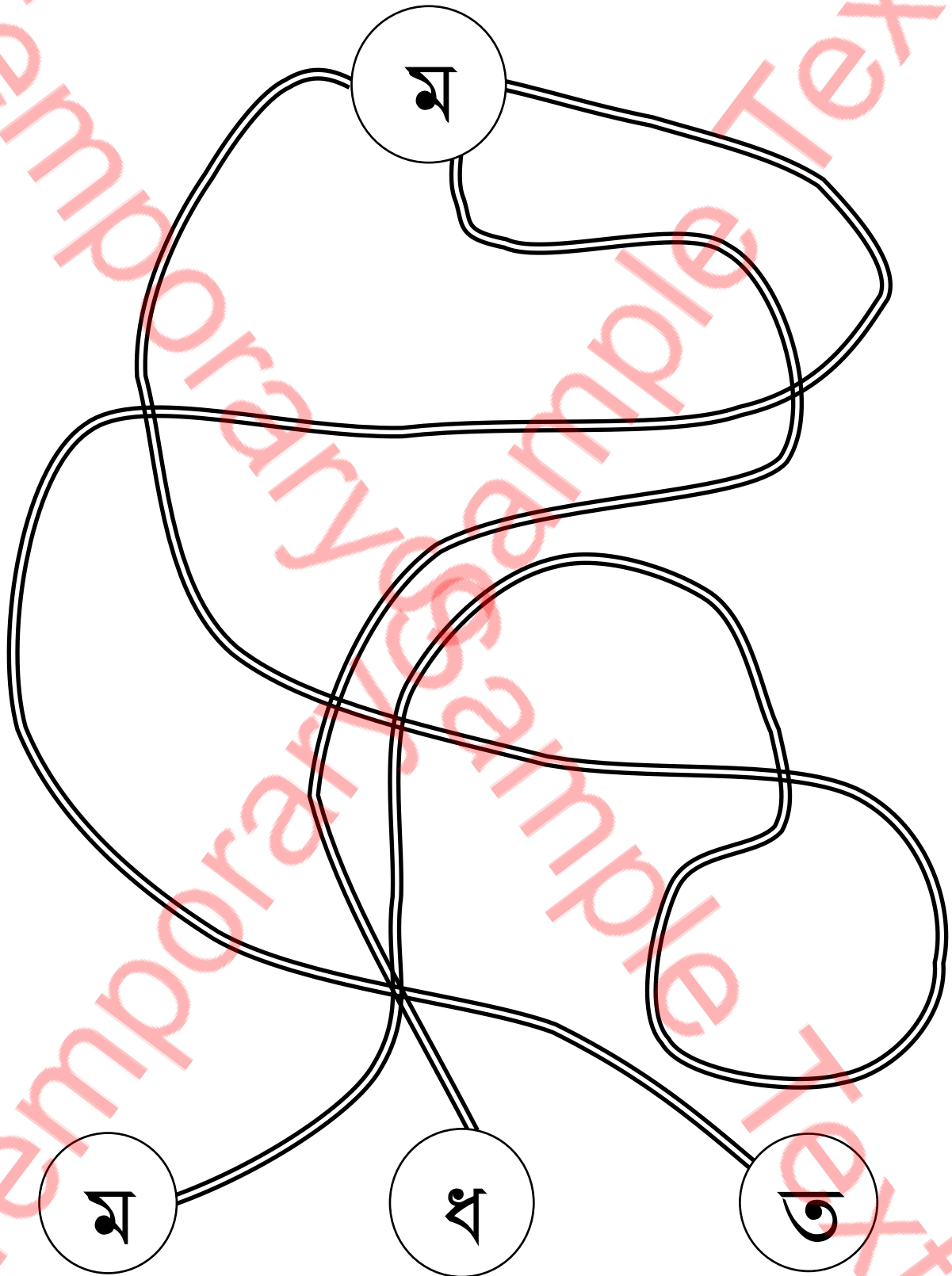

Student Name: \_\_\_\_\_

Verified By: \_\_\_\_\_

Class: \_\_\_\_\_

Date: \_\_\_\_\_



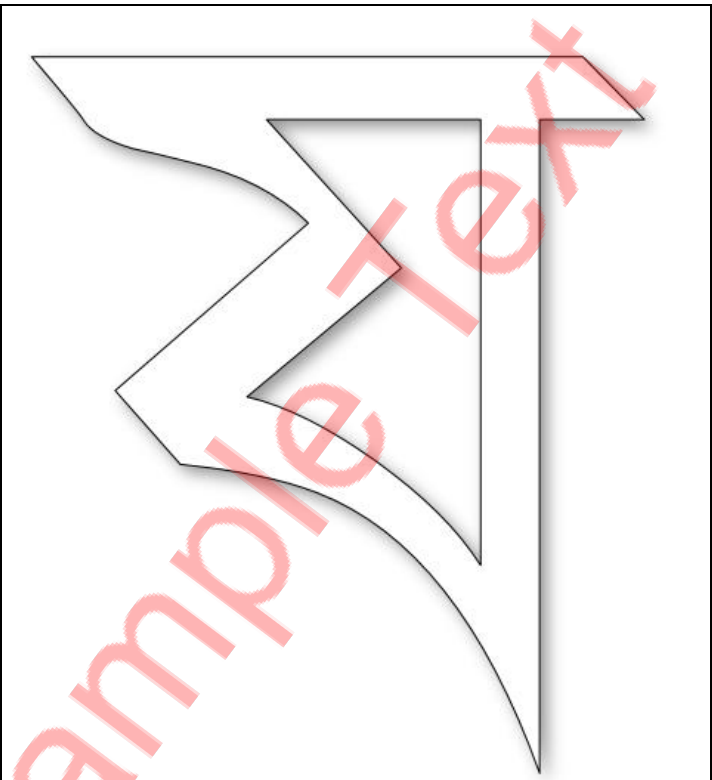
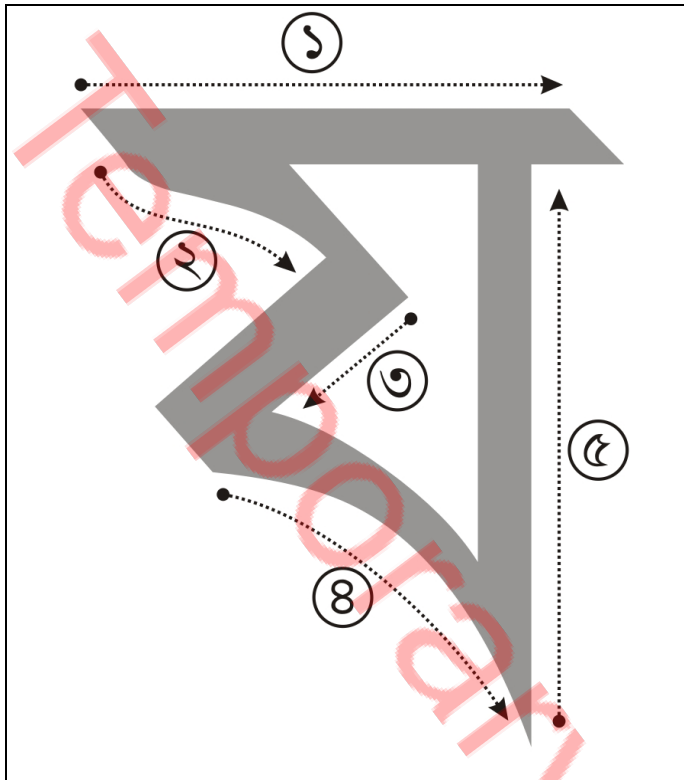

Follow the above steps

Colour it accordingly

ক	খ	গ	ঘ	ঙ	চ	ছ	জ
ঝ	ঞ	ট	ঠ	ড	ঢ	ণ	ত
থ	দ	ধ	ন	প	ফ	ব	ভ
ম	য	র	ল	শ	ষ	স	
হ	ক্ষ	জ	ড	য়	ং	ঃ	ৎ

Student Name: \_\_\_\_\_

Verified By: \_\_\_\_\_

Class: \_\_\_\_\_

Date: \_\_\_\_\_

## Trace It



Student Name: \_\_\_\_\_

Verified By: \_\_\_\_\_

Class: \_\_\_\_\_

Date: \_\_\_\_\_

# Trace it



Student Name: \_\_\_\_\_

Verified By: \_\_\_\_\_

Class: \_\_\_\_\_

Date: \_\_\_\_\_

Write it

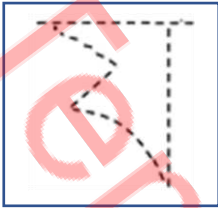
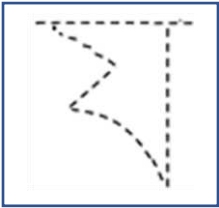
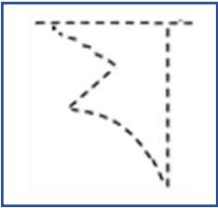
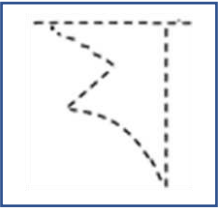
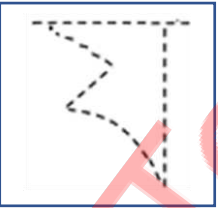
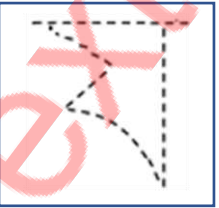
Student Name: \_\_\_\_\_

Verified By: \_\_\_\_\_

Class: \_\_\_\_\_

Date: \_\_\_\_\_

Copy Colour



Colour it

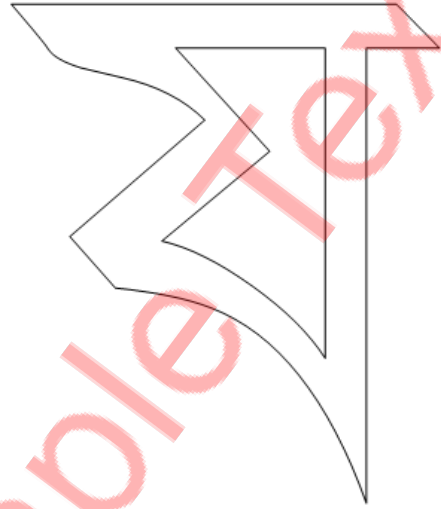

Write it

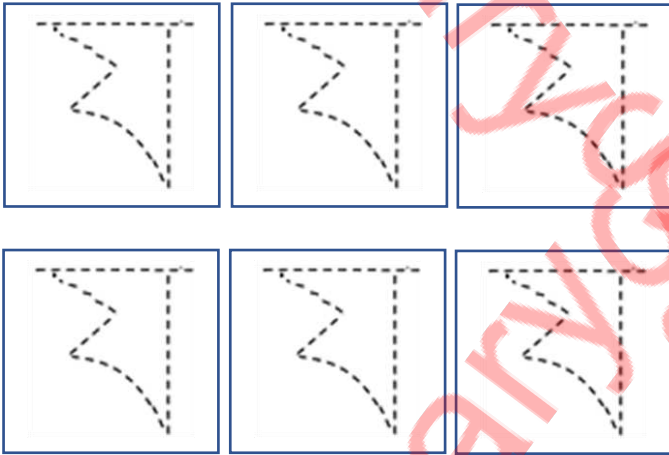

Find it

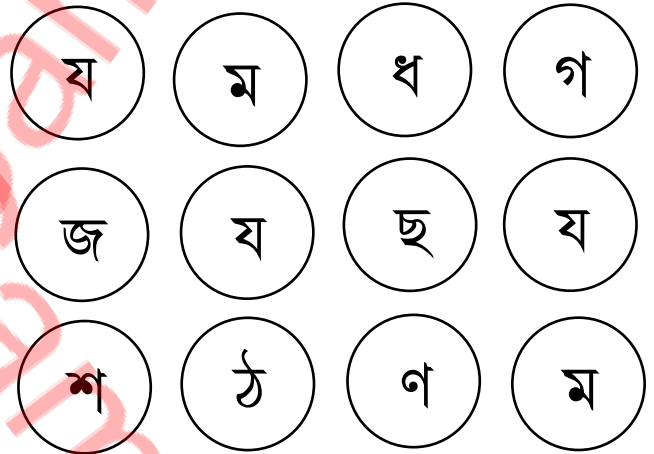

Connect the circle

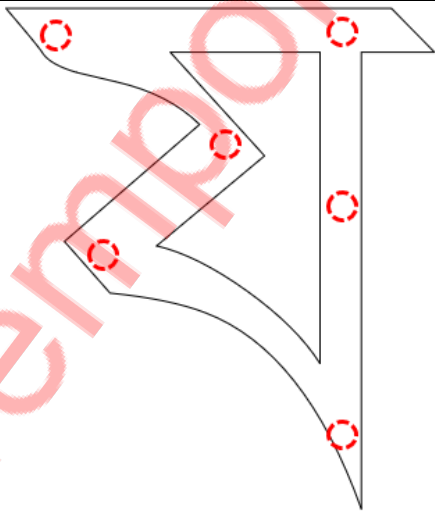

Do it

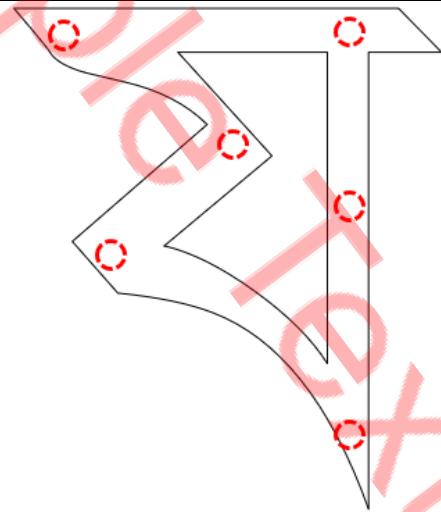

Student Name: \_\_\_\_\_

Verified By: \_\_\_\_\_

Class: \_\_\_\_\_

Date: \_\_\_\_\_

## Pick the Path Find the Correct Alphabet

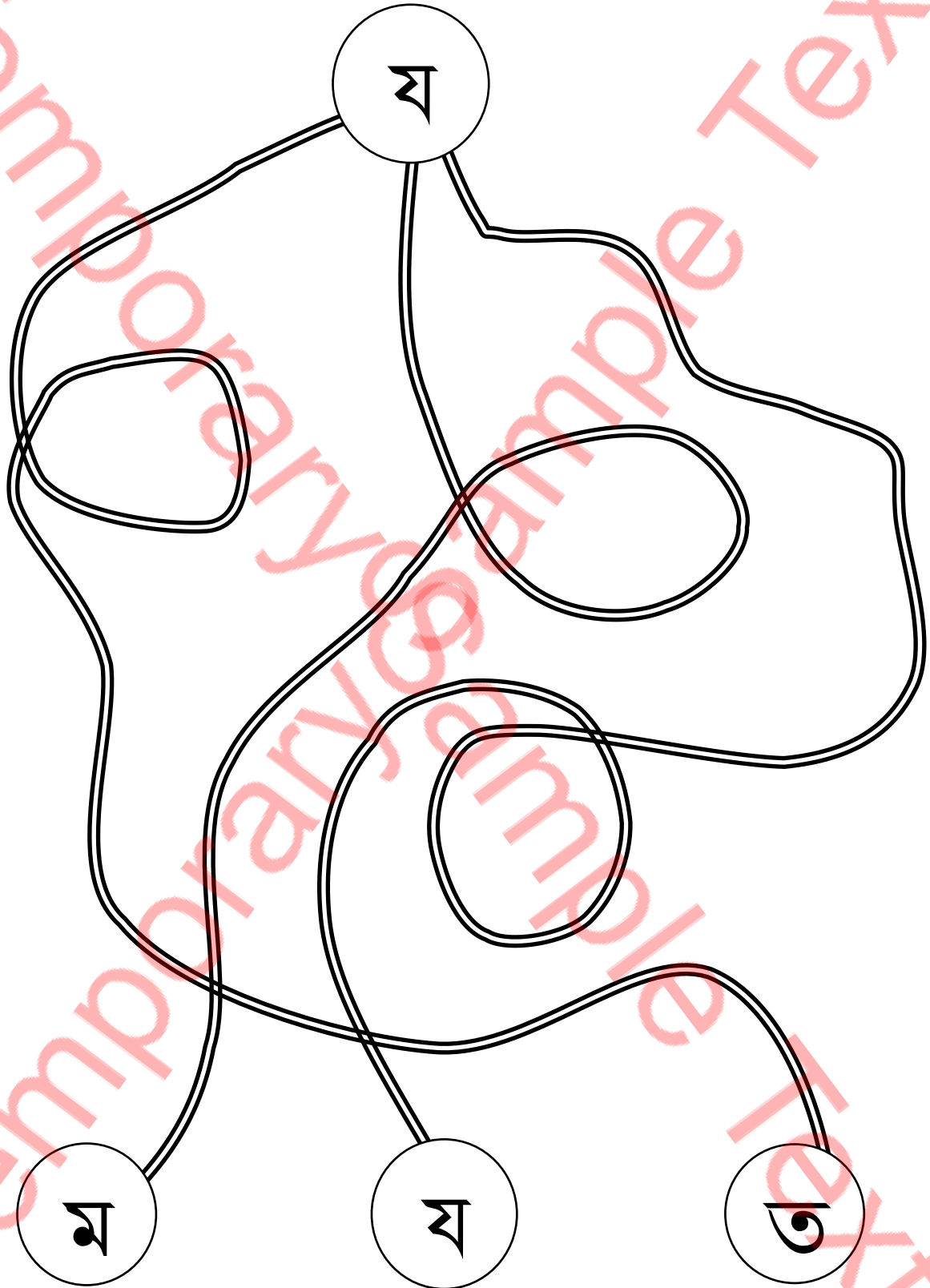

Student Name: \_\_\_\_\_

Verified By: \_\_\_\_\_

Class: \_\_\_\_\_

Date: \_\_\_\_\_



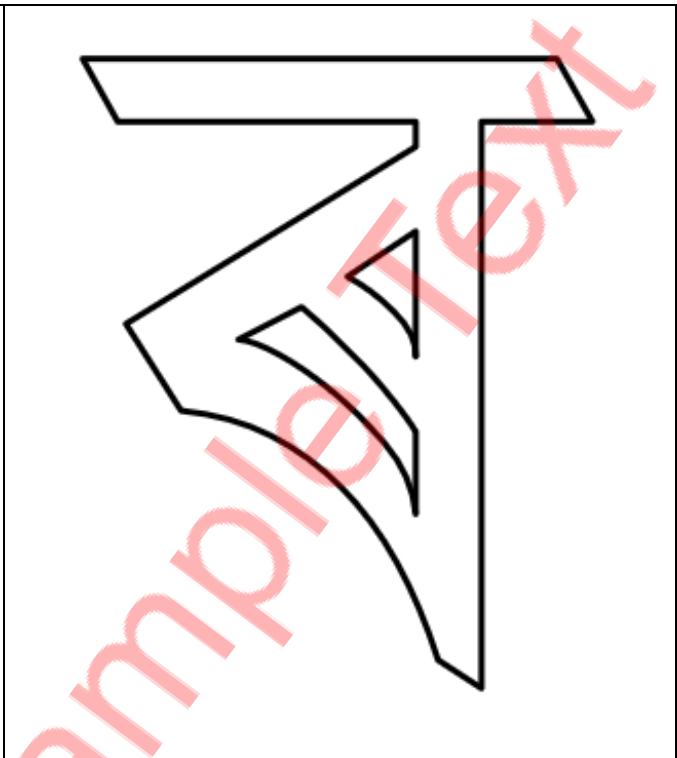
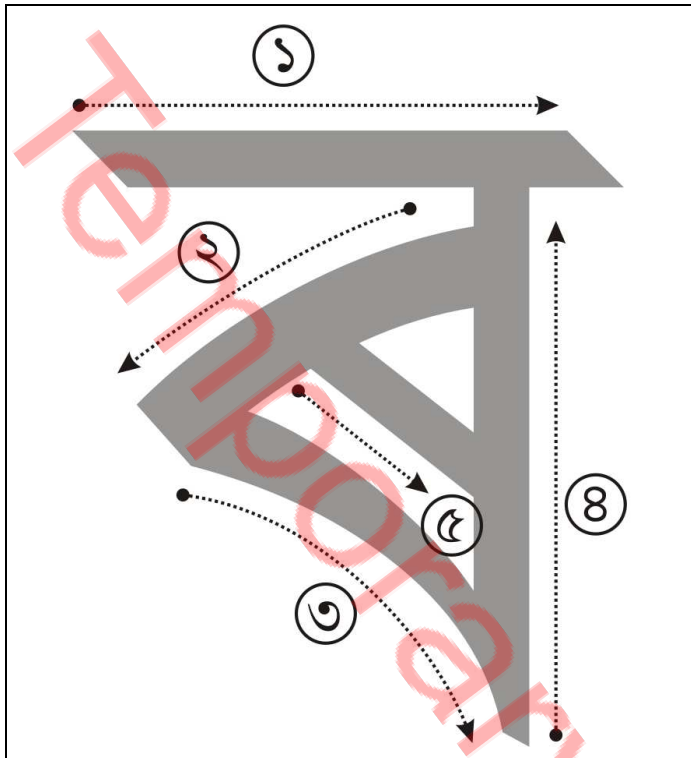

Follow the above steps

Colour it accordingly

ক	খ	গ	ঘ	ঙ	চ	ছ	জ
ঝ	ঞ	ট	ঠ	ড	ঢ	ণ	ত
থ	দ	ধ	ন	প	ফ	ব	ভ
ম	য	ষ	র	ষ	শ	ষ	স
হ	ক্ষ	ড়	ঢ়	য়	ং	ঃ	ঁ

Student Name: \_\_\_\_\_

Verified By: \_\_\_\_\_

Class: \_\_\_\_\_

Date: \_\_\_\_\_

# Trace It

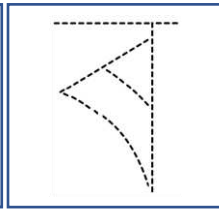
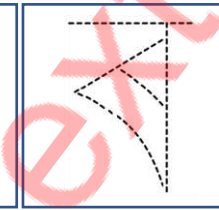
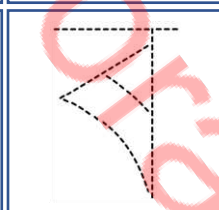
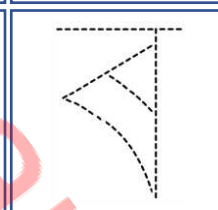
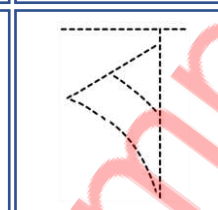
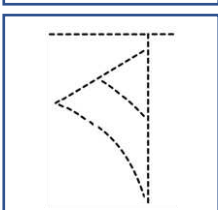
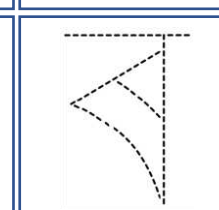
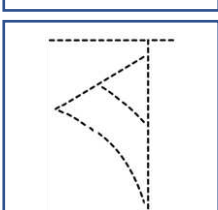
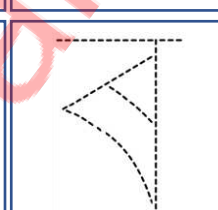
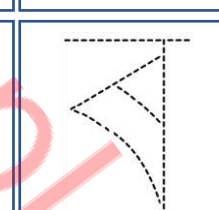
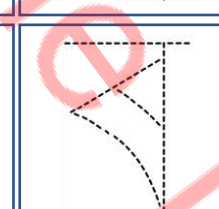
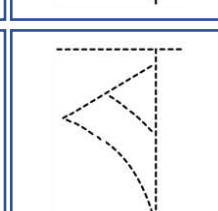
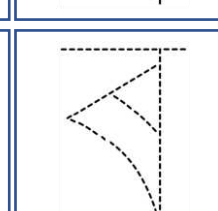
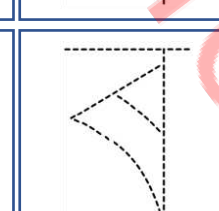
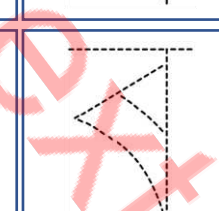
Student Name: \_\_\_\_\_

Verified By: \_\_\_\_\_

Class: \_\_\_\_\_

Date: \_\_\_\_\_

# Trace it

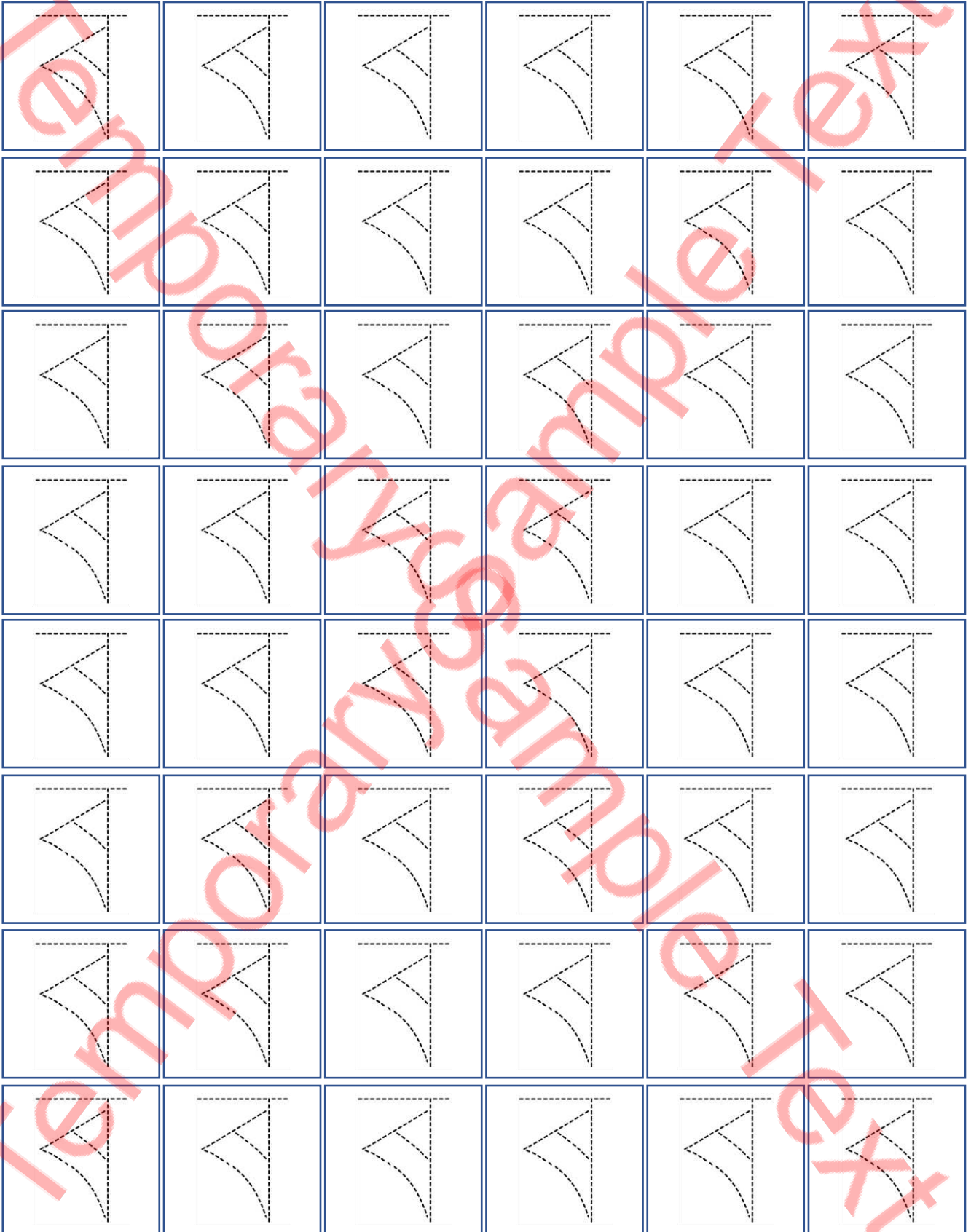

Student Name: \_\_\_\_\_

Verified By: \_\_\_\_\_

Class: \_\_\_\_\_

Date: \_\_\_\_\_

# Write it

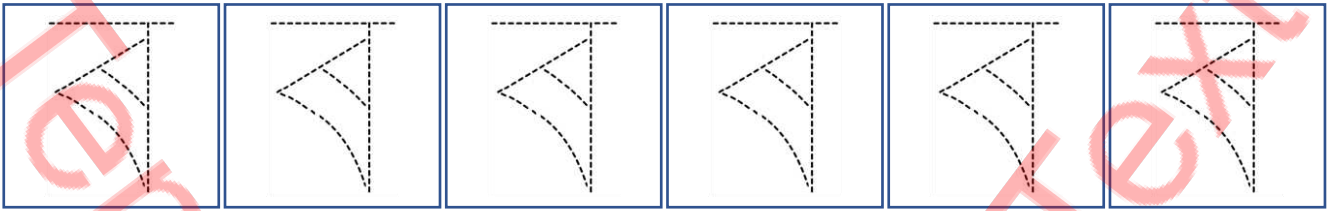



Student Name: \_\_\_\_\_

Verified By: \_\_\_\_\_

Class: \_\_\_\_\_

Date: \_\_\_\_\_

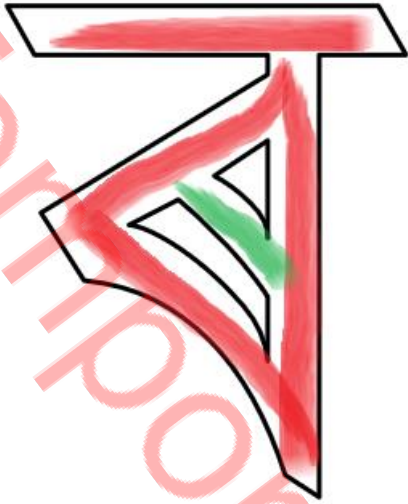
Copy Colour



Colour it

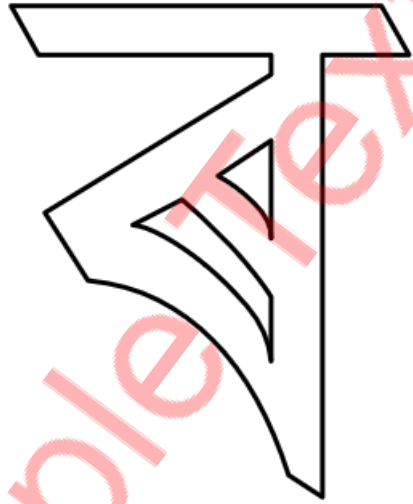

Write it

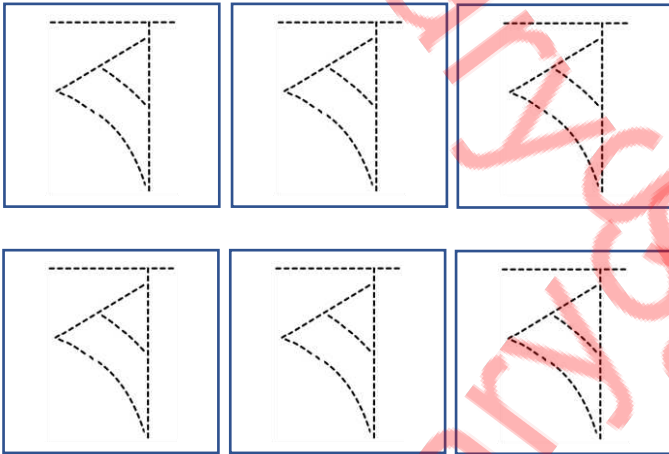

Find it

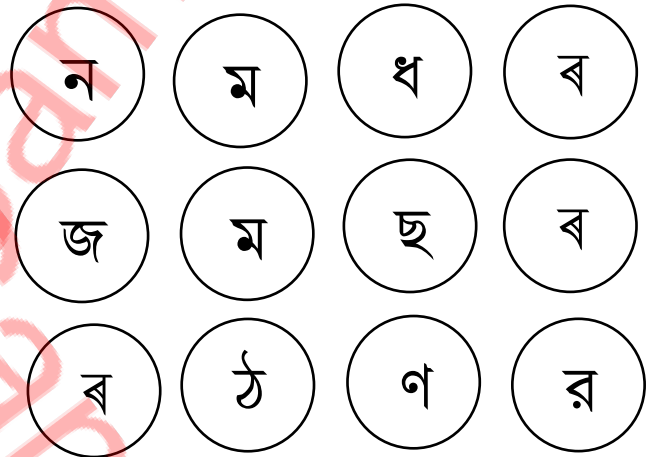

Connect the circle

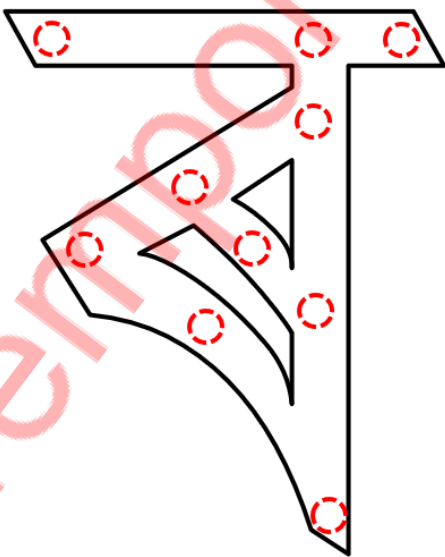

Do it

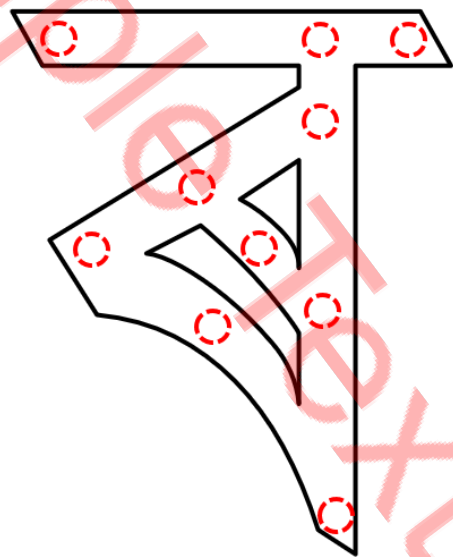

Student Name: \_\_\_\_\_

Verified By: \_\_\_\_\_

Class: \_\_\_\_\_

Date: \_\_\_\_\_

## Pick the Path Find the Correct Alphabet

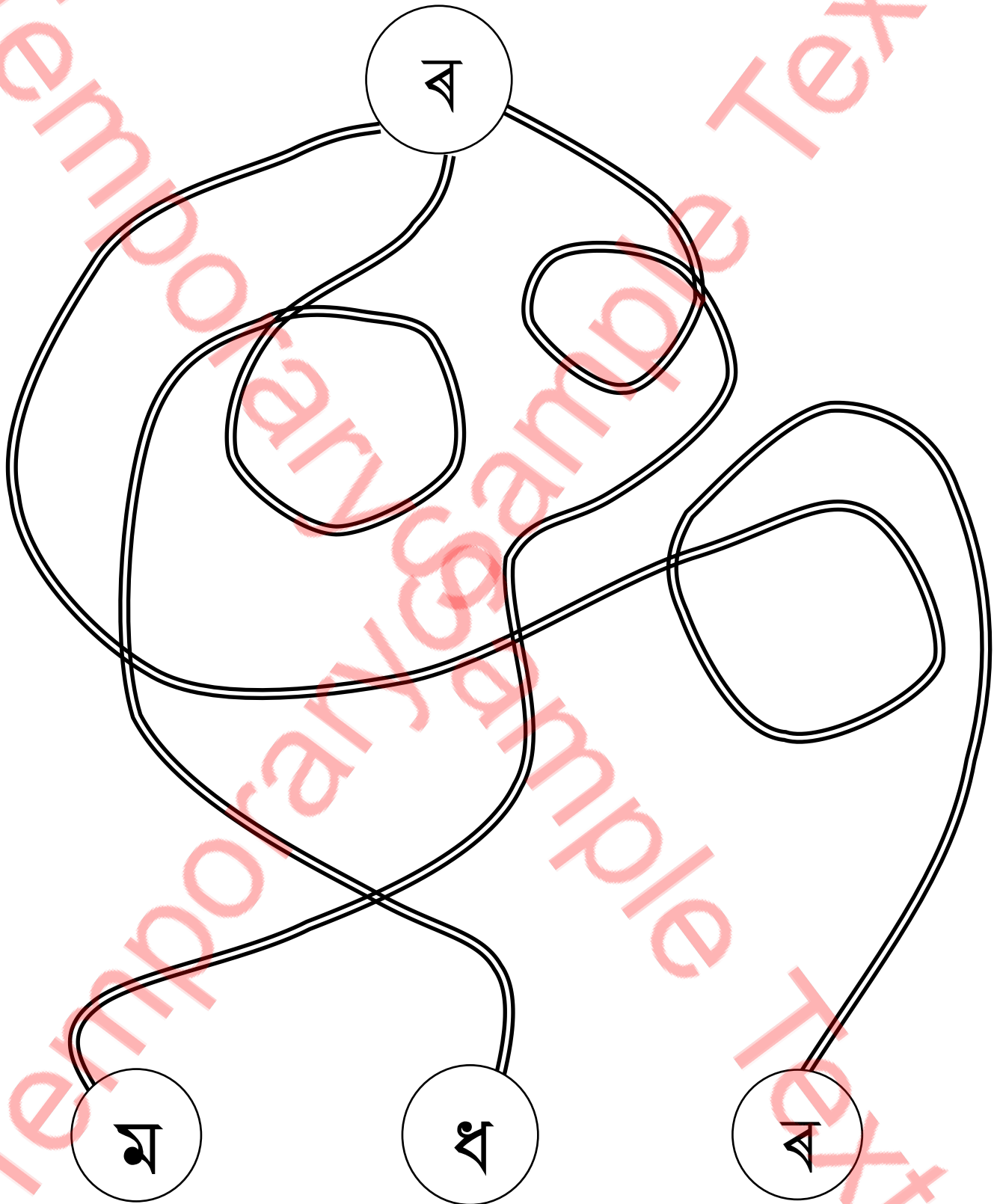

Student Name: \_\_\_\_\_

Class: \_\_\_\_\_

Verified By: \_\_\_\_\_

Date: \_\_\_\_\_



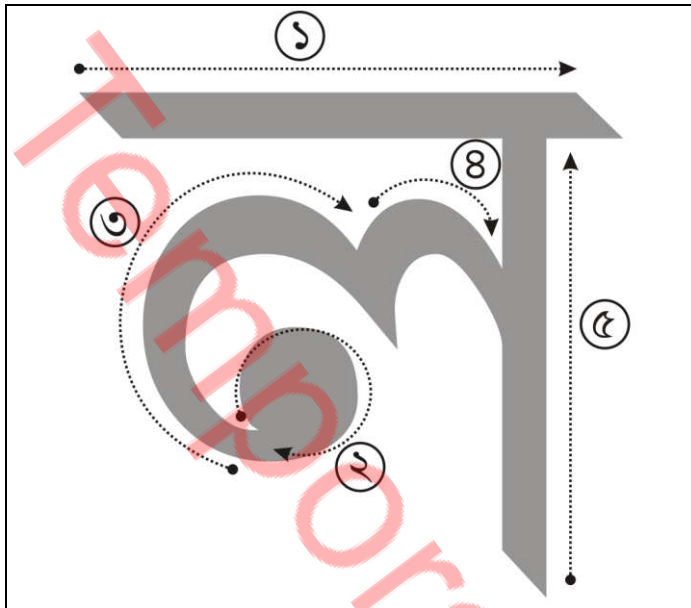

Follow the above steps

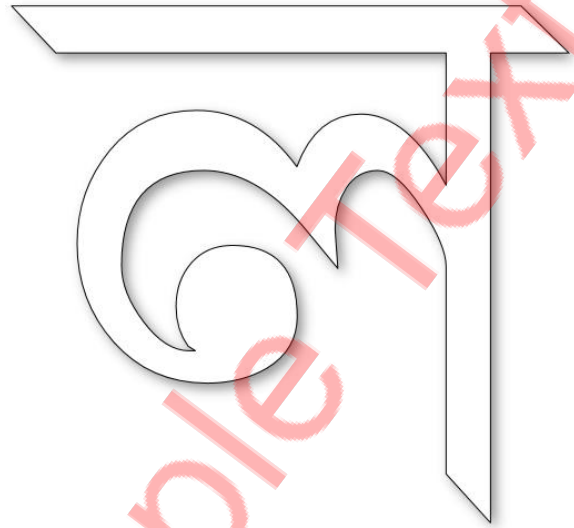

Colour it accordingly

ক	খ	গ	ঘ	ঙ	চ	ছ	জ
ঝ	ঞ	ট	ঠ	ড	ঢ	ণ	ত
থ	দ	ধ	ন	প	ফ	ব	ভ
ম	য	র	ল	শ	ষ	স	
হ	ক্ষ	ড়	ঢ়	য়	ং	ঃ	ঁ

Student Name: \_\_\_\_\_

Verified By: \_\_\_\_\_

Class: \_\_\_\_\_

Date: \_\_\_\_\_

## Trace It

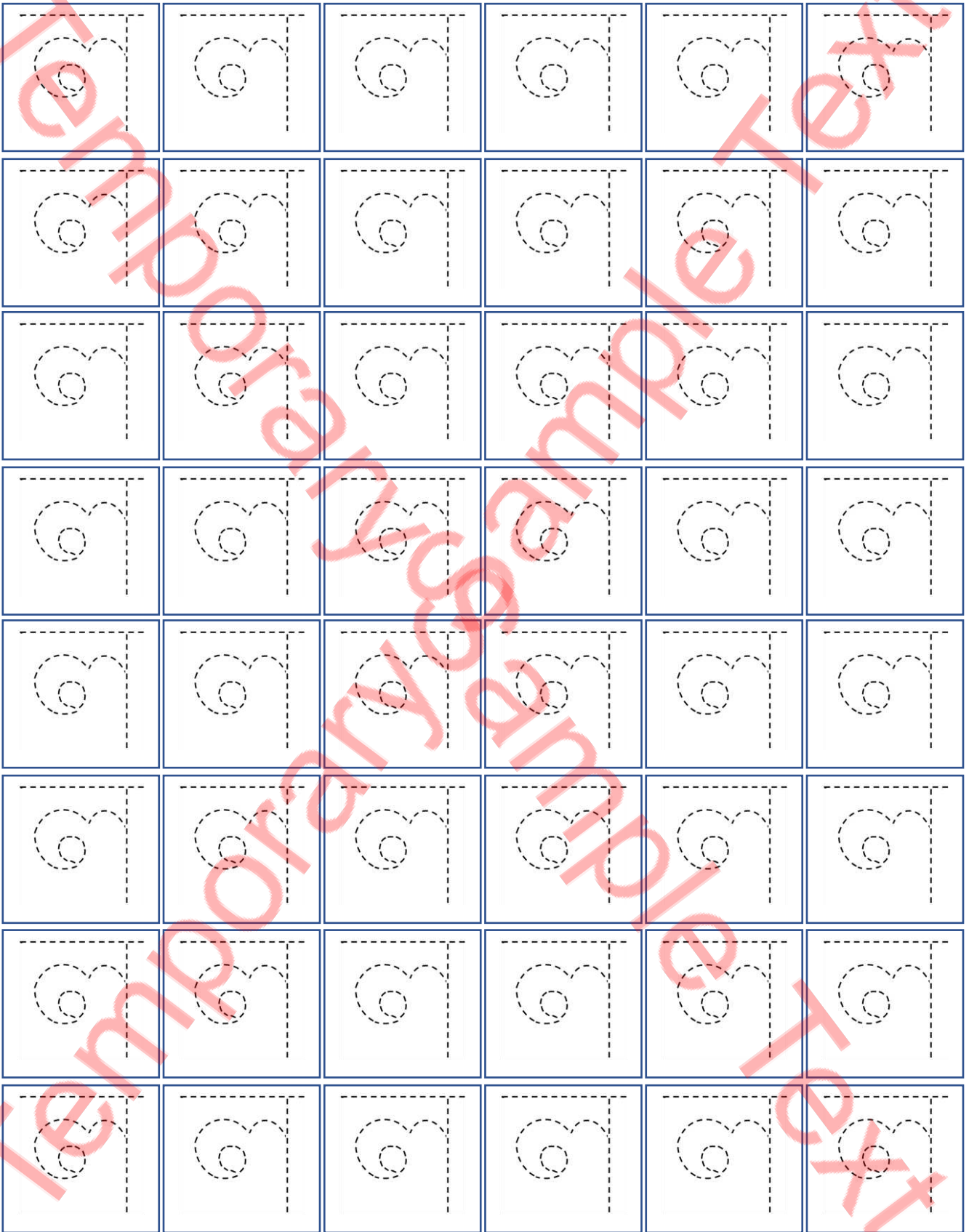

Student Name: \_\_\_\_\_

Verified By: \_\_\_\_\_

Class: \_\_\_\_\_

Date: \_\_\_\_\_

# Trace it



Student Name: \_\_\_\_\_

Verified By: \_\_\_\_\_

Class: \_\_\_\_\_

Date: \_\_\_\_\_

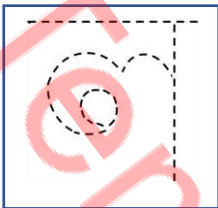
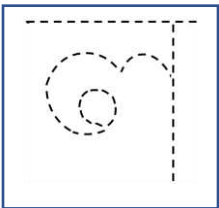
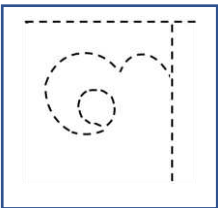
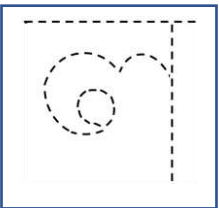
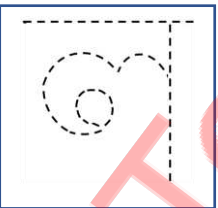
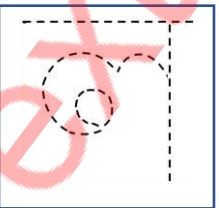
# Write it

Student Name: \_\_\_\_\_

Verified By: \_\_\_\_\_

Class: \_\_\_\_\_

Date: \_\_\_\_\_

Copy Colour

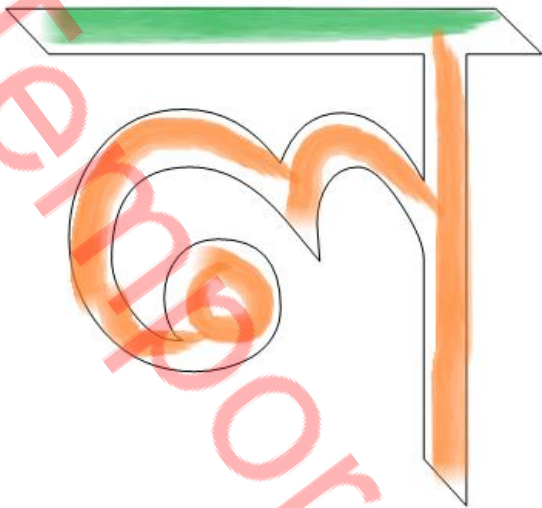

Colour it

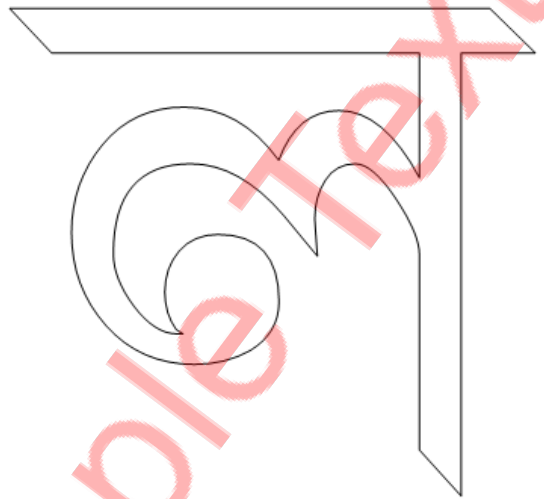

Write it

Find it

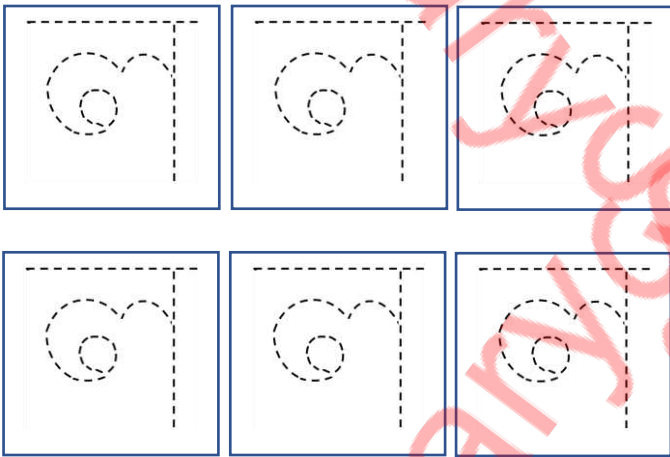

Connect the circle

Do it

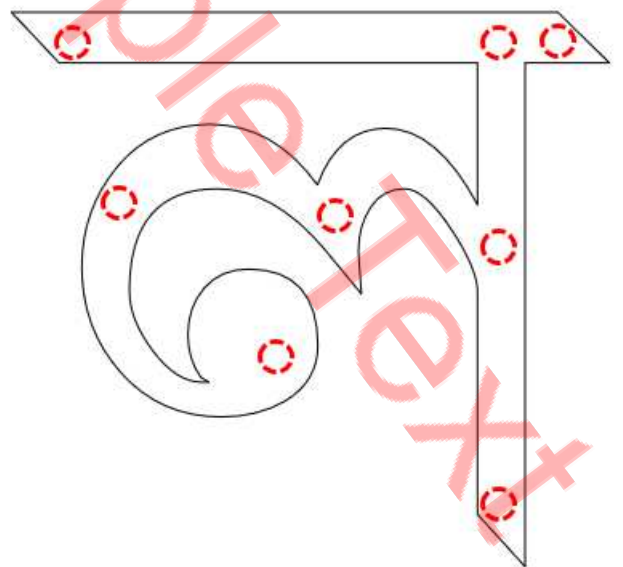
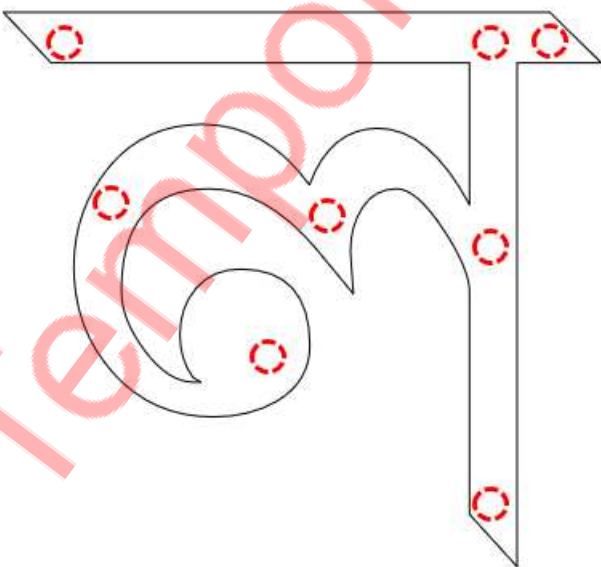

Student Name: \_\_\_\_\_

Verified By: \_\_\_\_\_

Class: \_\_\_\_\_

Date: \_\_\_\_\_

# Pick the Path Find the Correct Alphabet

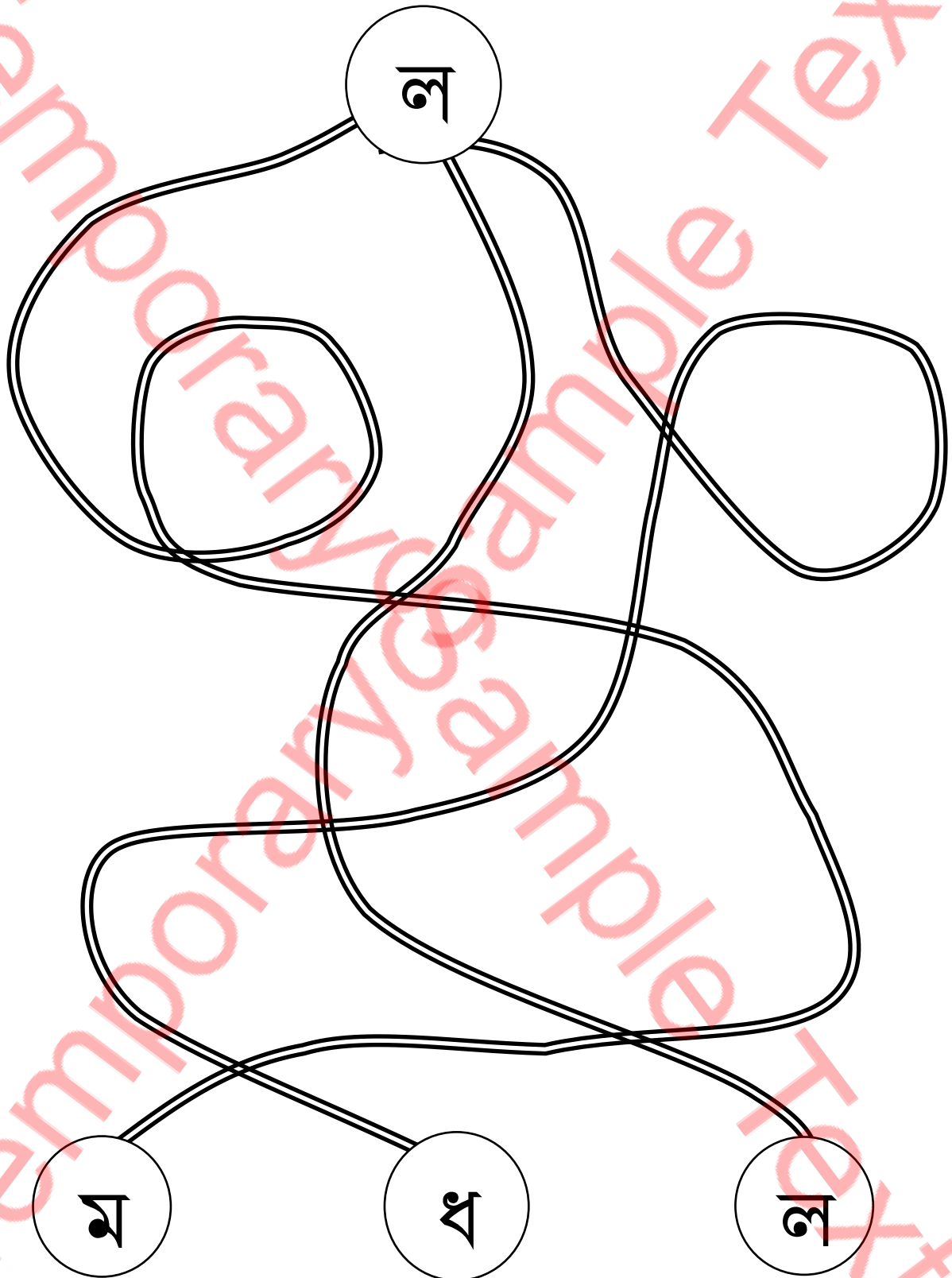

Student Name: \_\_\_\_\_

Verified By: \_\_\_\_\_

Class: \_\_\_\_\_

Date: \_\_\_\_\_



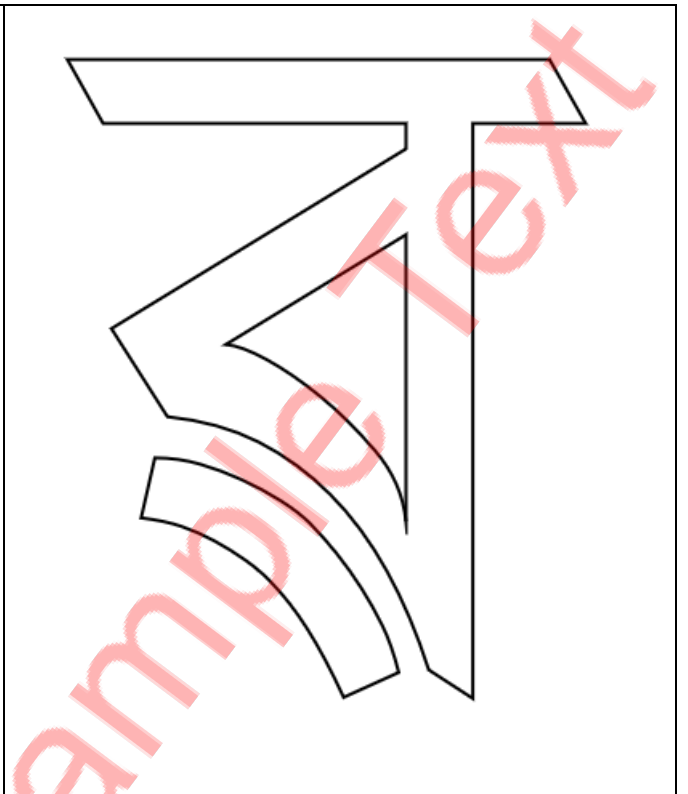
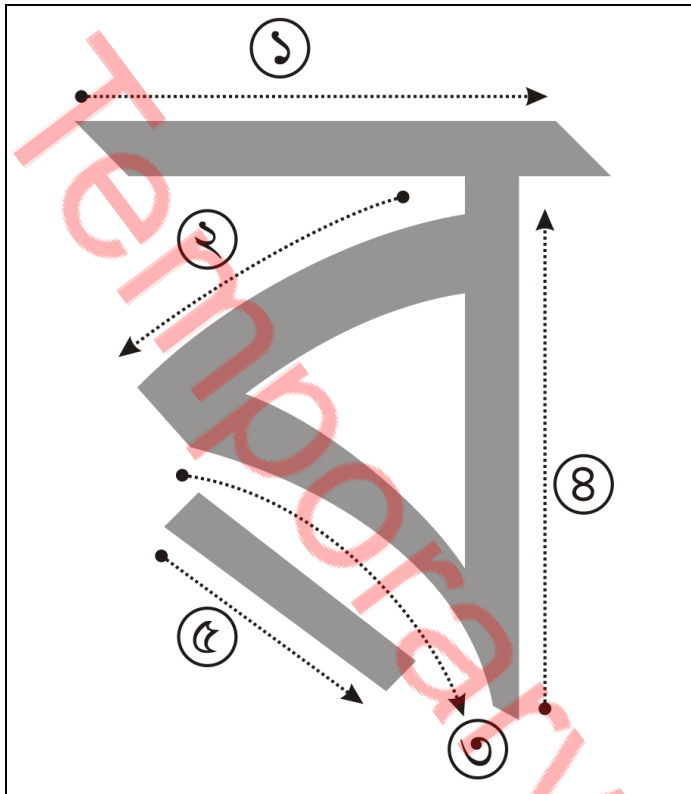

Follow the above steps

Colour it accordingly

ক	খ	গ	ঘ	ঙ	চ	ছ	জ
ঝ	ঞ	ট	ঠ	ড	ঢ	ণ	ত
থ	দ	ধ	ন	প	ফ	ব	ভ
ম	য	ষ	শ	ষ	শ	ষ	স
হ	ক্ষ	ড়	ঢ়	য়	ং	ঃ	়

Student Name: \_\_\_\_\_

Verified By: \_\_\_\_\_

Class: \_\_\_\_\_

Date: \_\_\_\_\_

# Trace It

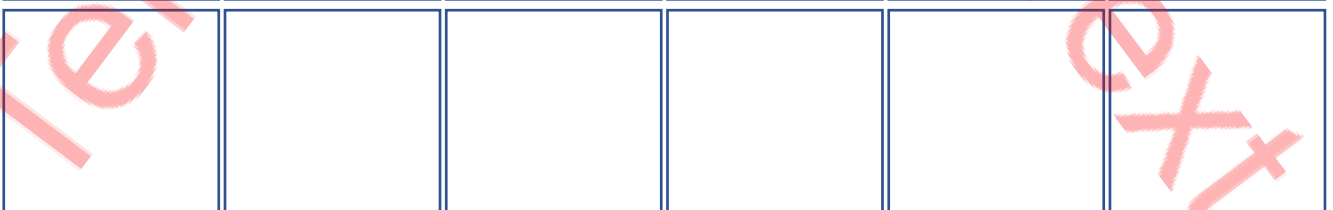
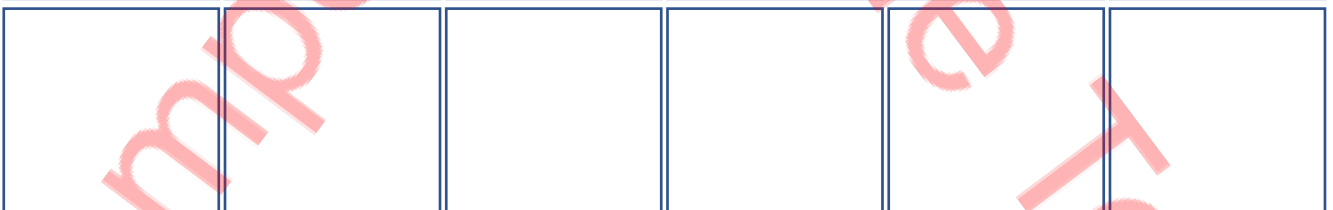
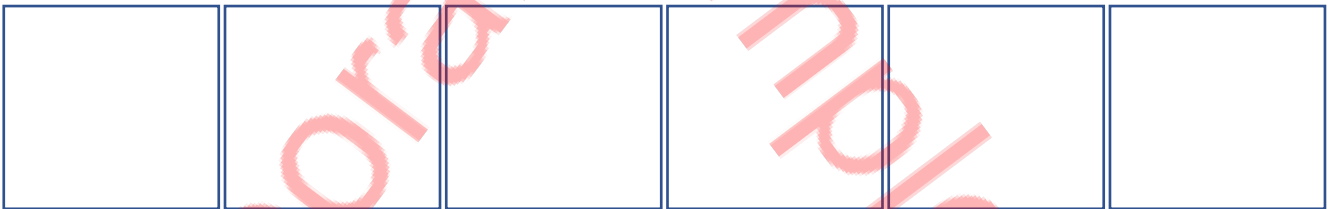
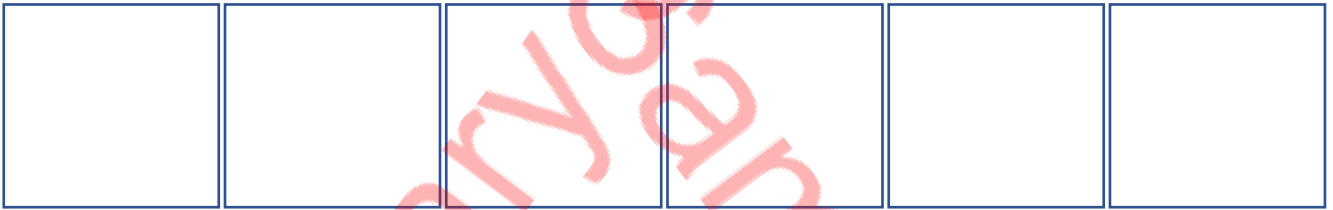
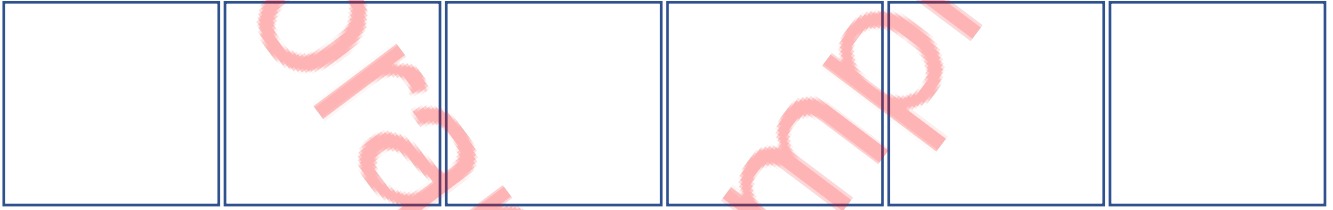
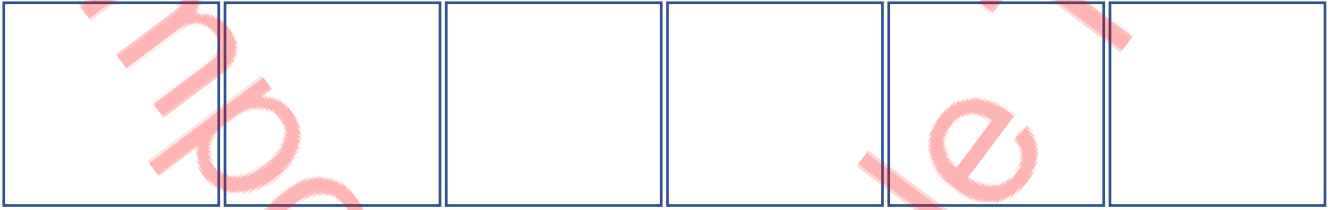
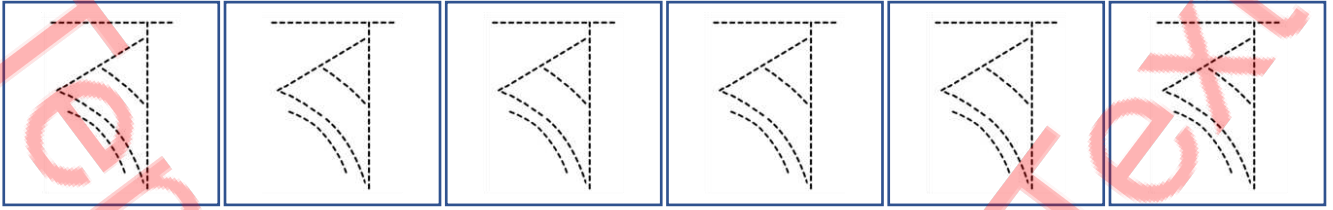

Student Name: \_\_\_\_\_

Verified By: \_\_\_\_\_

Class: \_\_\_\_\_

Date: \_\_\_\_\_

# Trace it

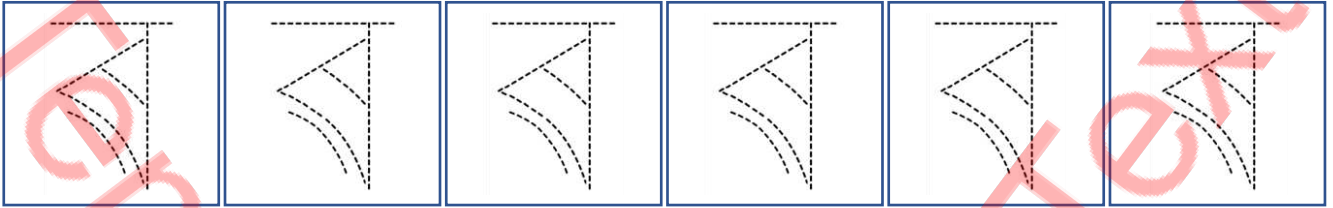



Student Name: \_\_\_\_\_

Verified By: \_\_\_\_\_

Class: \_\_\_\_\_

Date: \_\_\_\_\_

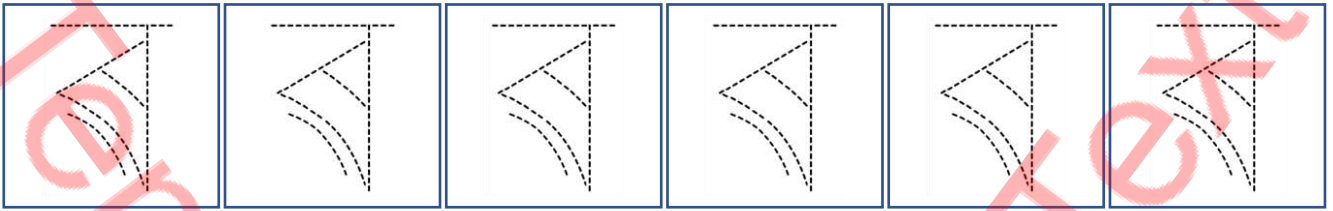
# Write it





Student Name: \_\_\_\_\_

Verified By: \_\_\_\_\_

Class: \_\_\_\_\_

Date: \_\_\_\_\_

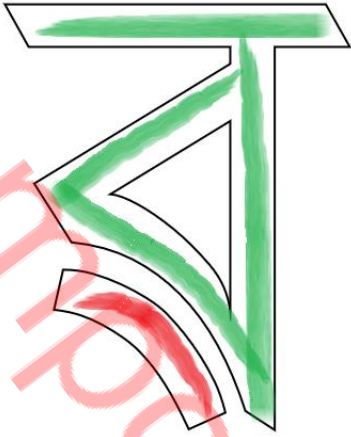
Copy Colour



Colour it



Write it

Find it

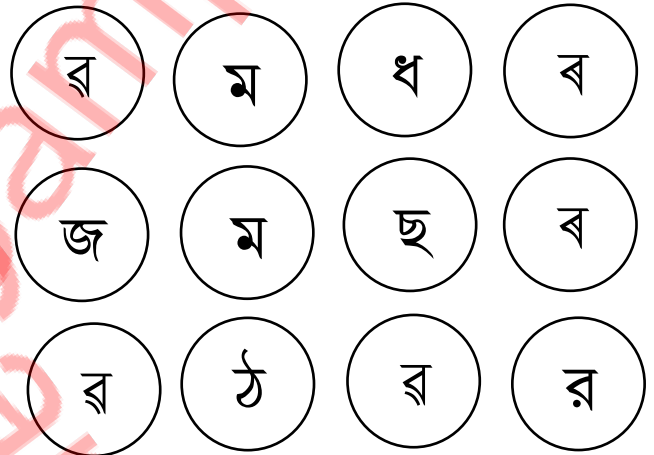
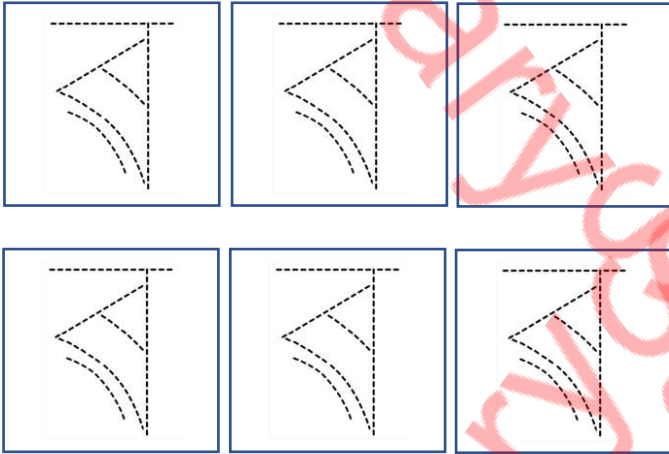

Connect the circle

Do it

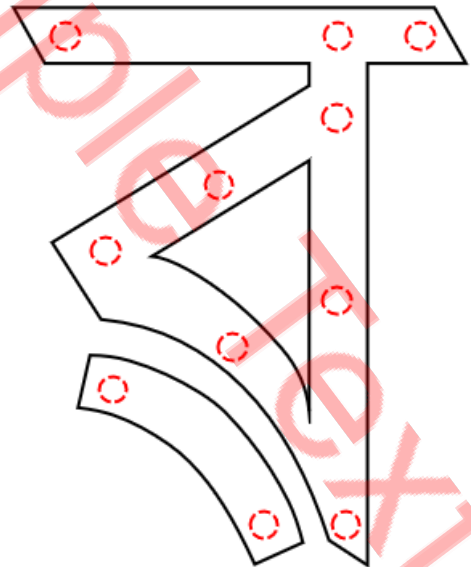
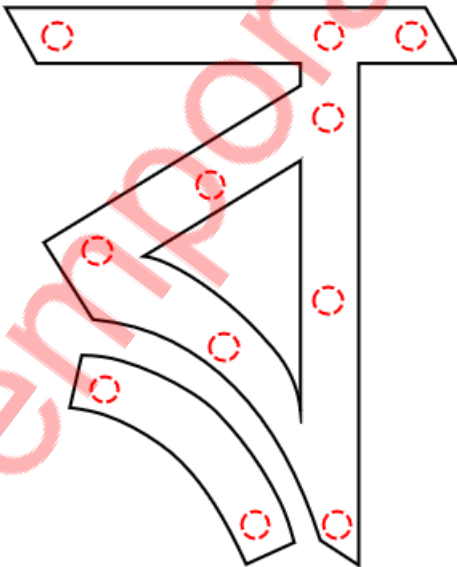

Student Name: \_\_\_\_\_

Verified By: \_\_\_\_\_

Class: \_\_\_\_\_

Date: \_\_\_\_\_

# Pick the Path Find the Correct Alphabet

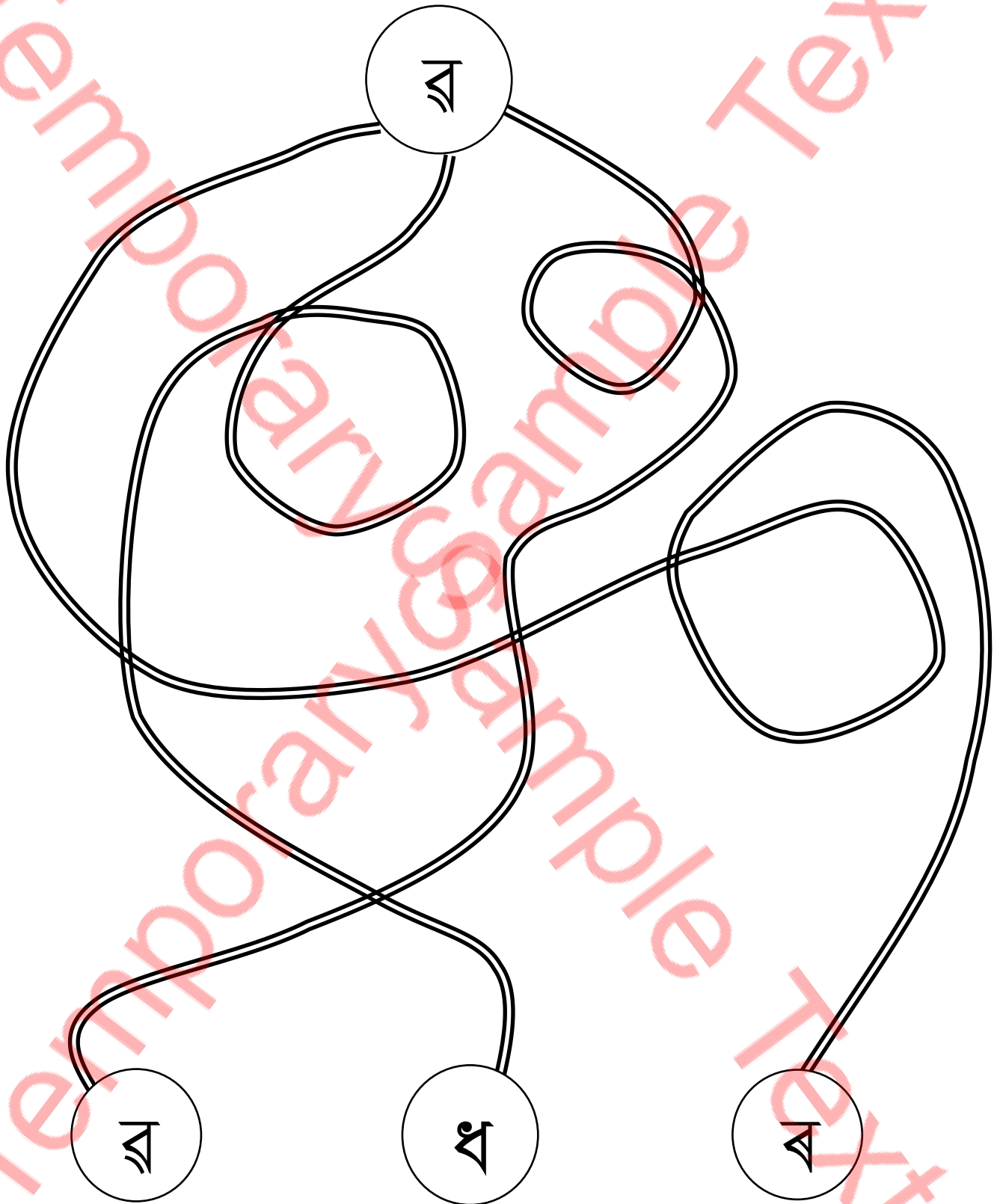

Student Name: \_\_\_\_\_

Verified By: \_\_\_\_\_

Class: \_\_\_\_\_

Date: \_\_\_\_\_



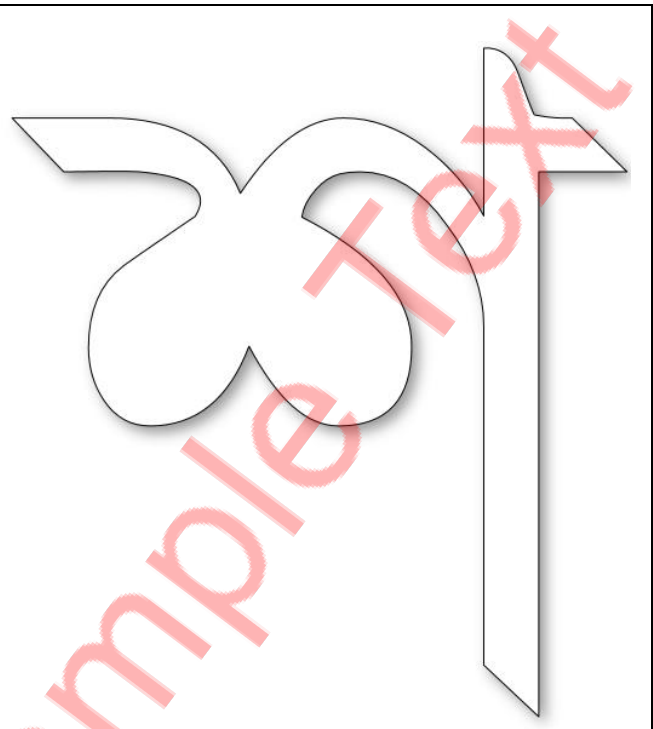
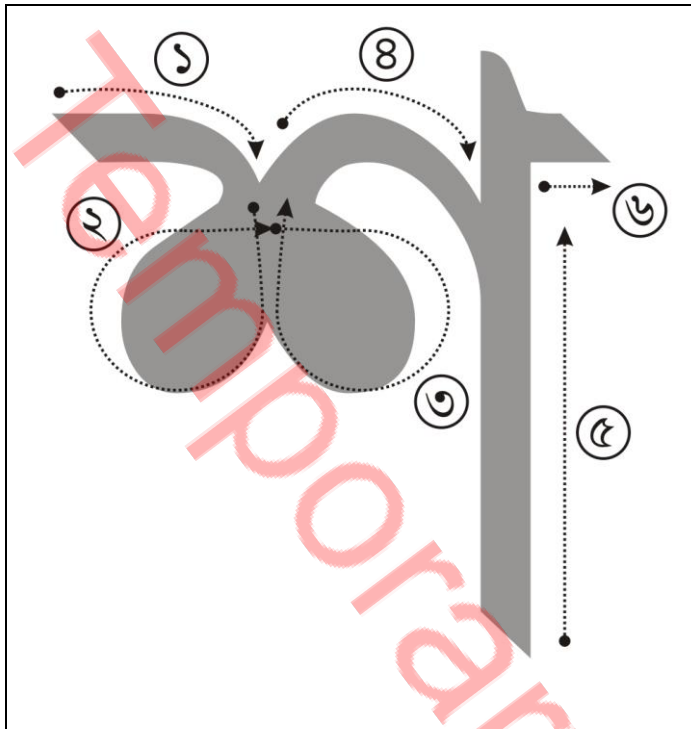

Follow the above steps

Colour it accordingly

ক	খ	গ	ঘ	ঙ	চ	ছ	জ
ঝ	ঞ	ট	ঠ	ড	ঢ	ণ	ত
থ	দ	ধ	ন	প	ফ	ব	ভ
ম	য	ষ	র	শ	ষ	স	
হ	ক্ষ	ড়	ঢ়	য়	ং	ঃ	ঁ

Student Name: \_\_\_\_\_

Verified By: \_\_\_\_\_

Class: \_\_\_\_\_

Date: \_\_\_\_\_

# Trace It

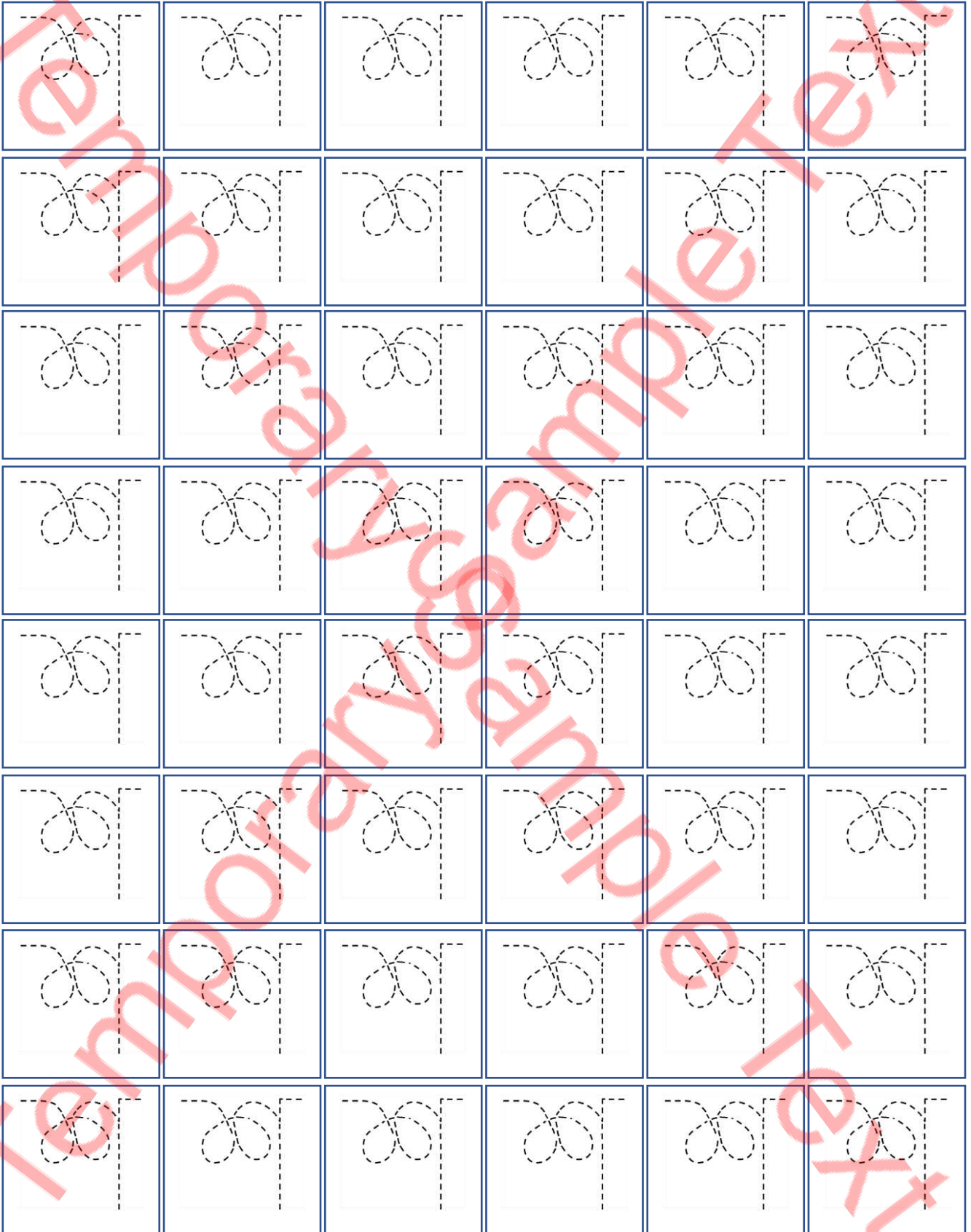

Student Name: \_\_\_\_\_

Verified By: \_\_\_\_\_

Class: \_\_\_\_\_

Date: \_\_\_\_\_

# Trace it

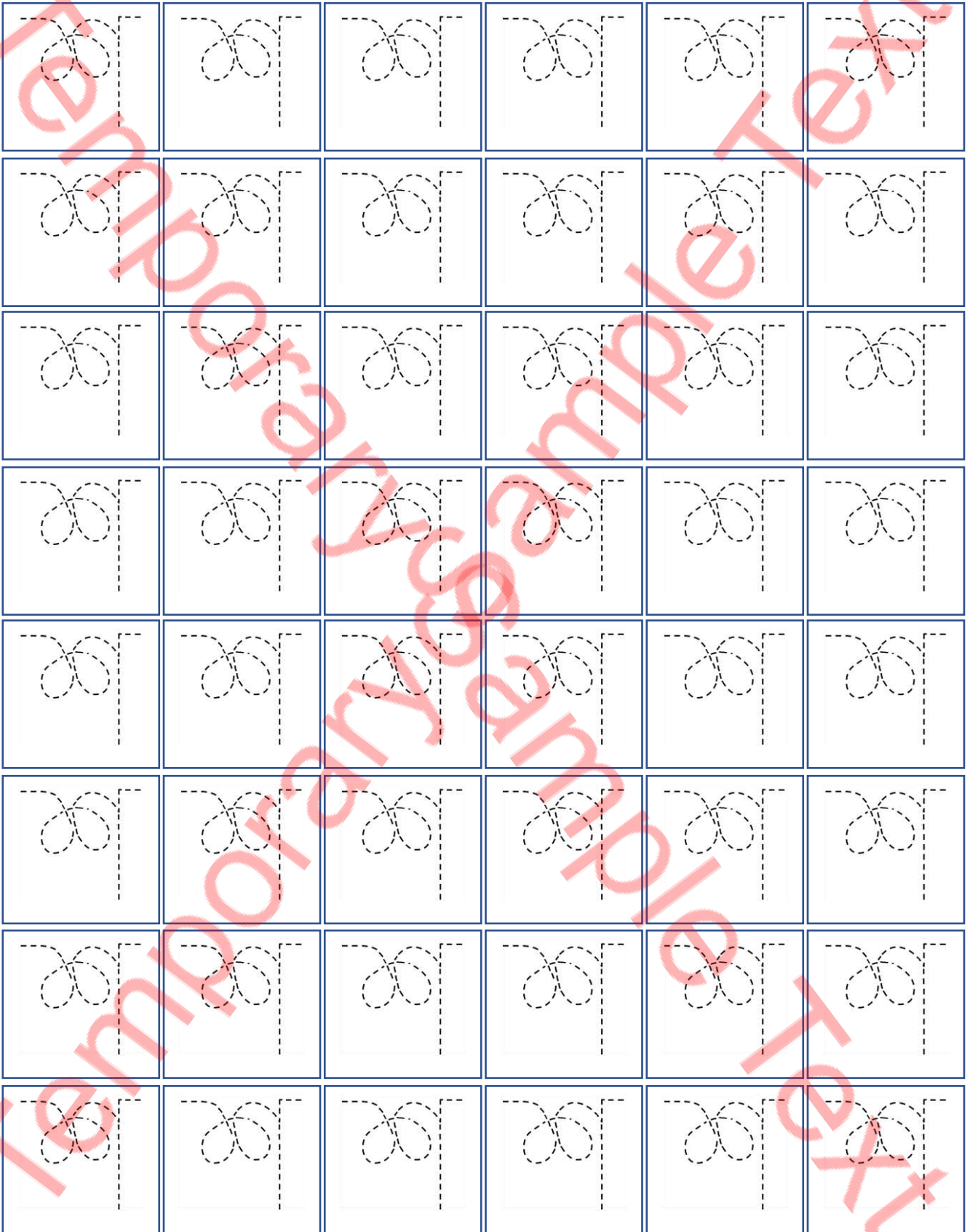

Student Name: \_\_\_\_\_

Verified By: \_\_\_\_\_

Class: \_\_\_\_\_

Date: \_\_\_\_\_

## Write it

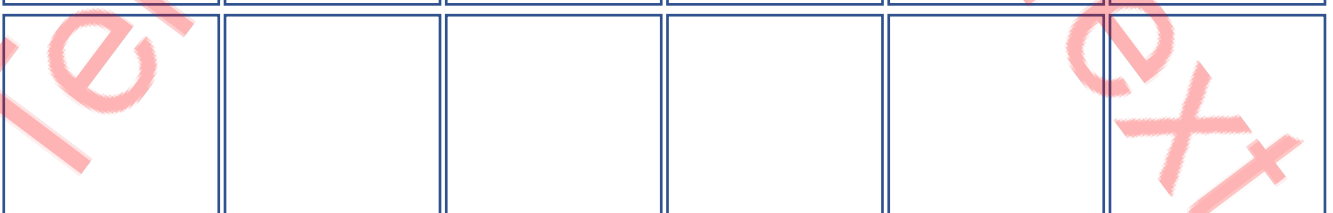
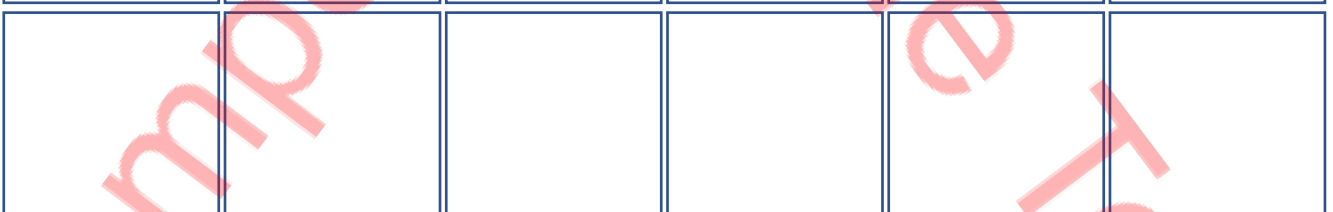
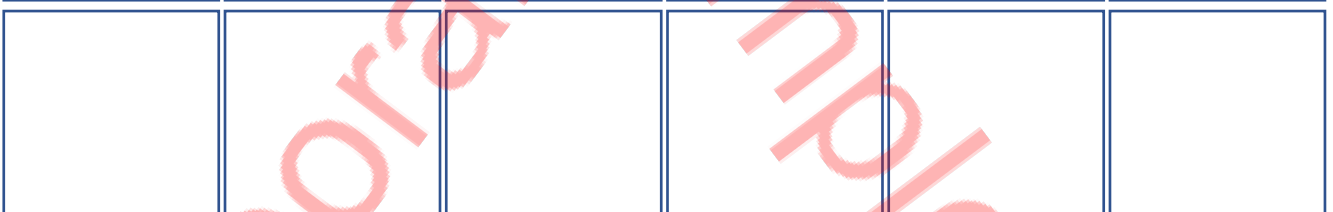
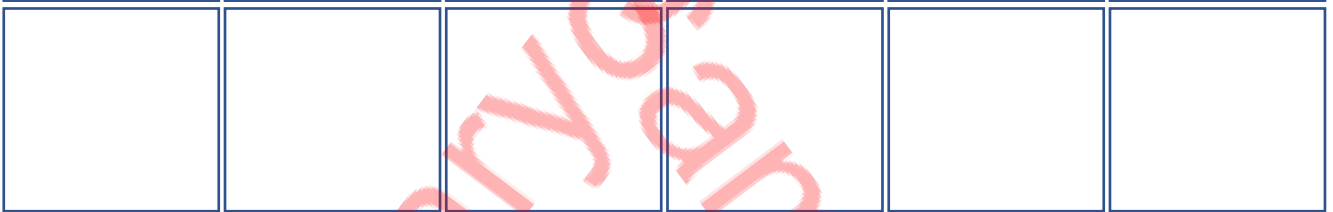
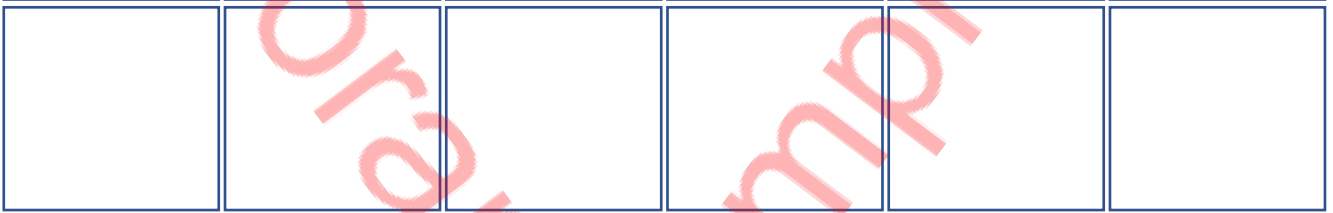
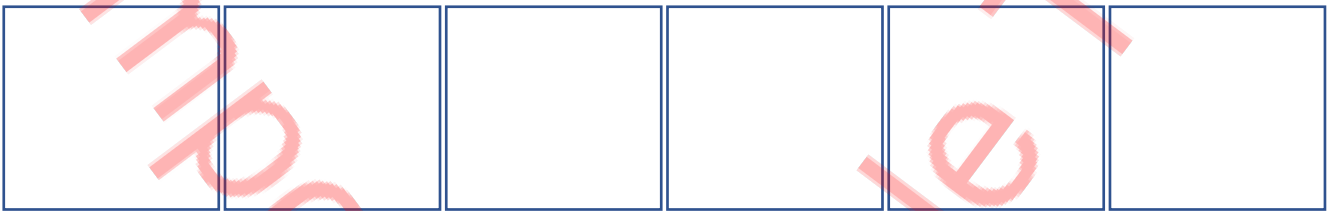
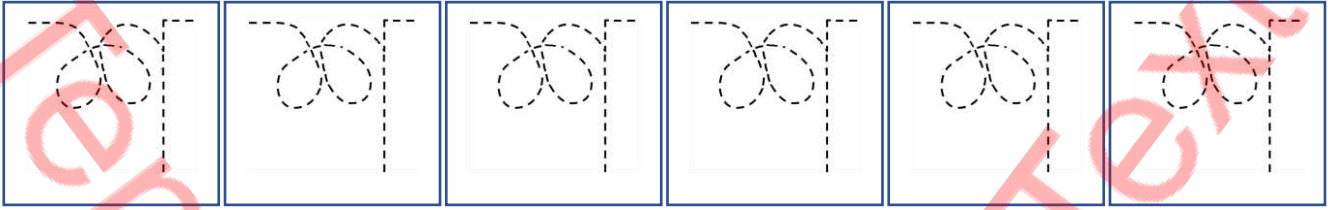

Student Name: \_\_\_\_\_

Verified By: \_\_\_\_\_

Class: \_\_\_\_\_

Date: \_\_\_\_\_

Copy Colour

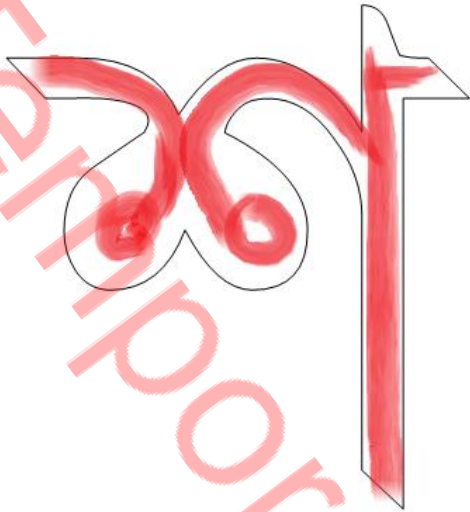

Colour it

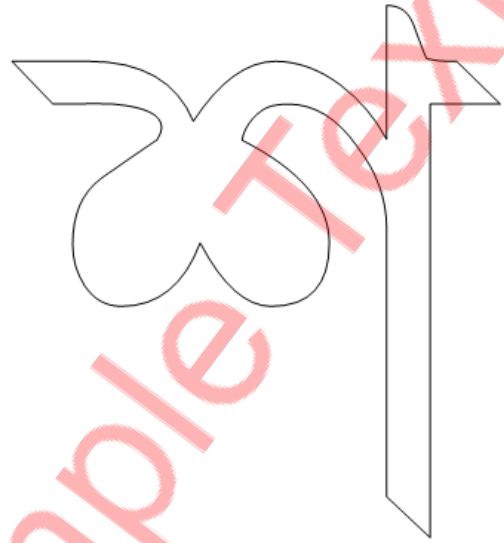

Write it

Find it

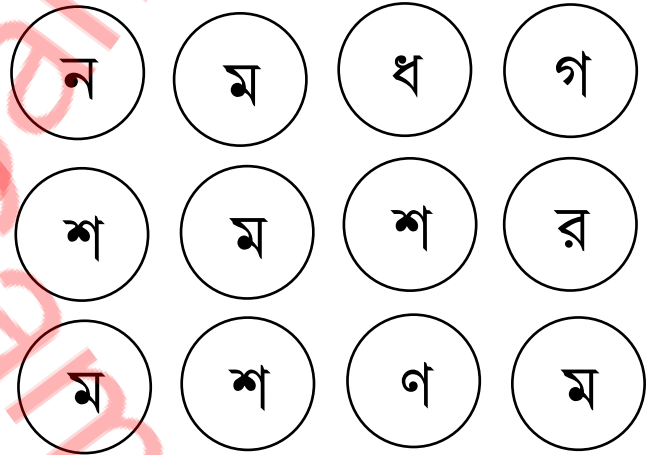
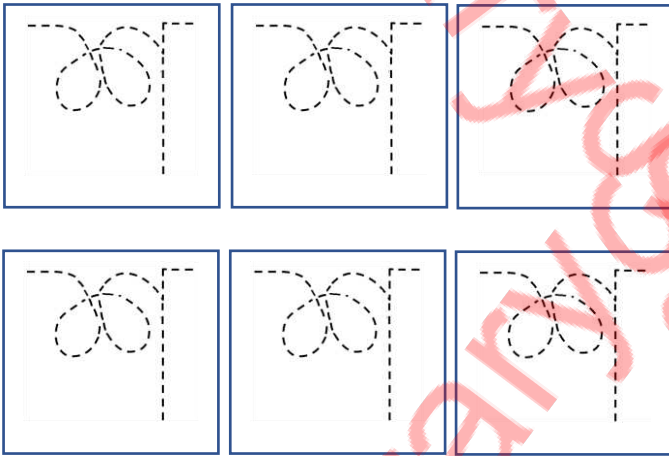

Connect the circle

Do it

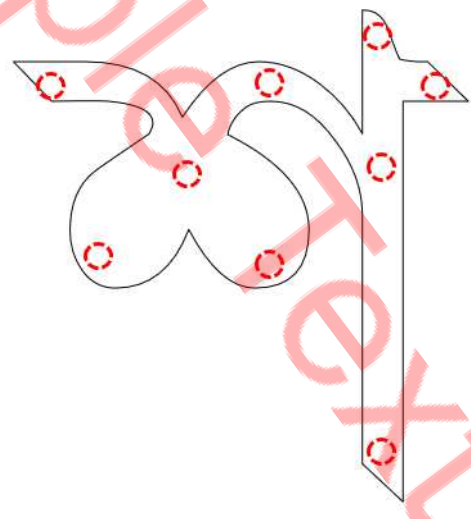
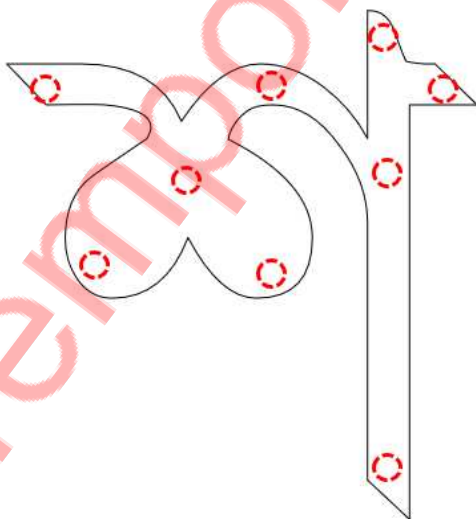

Student Name: \_\_\_\_\_

Verified By: \_\_\_\_\_

Class: \_\_\_\_\_

Date: \_\_\_\_\_

## Pick the Path Find the Correct Alphabet

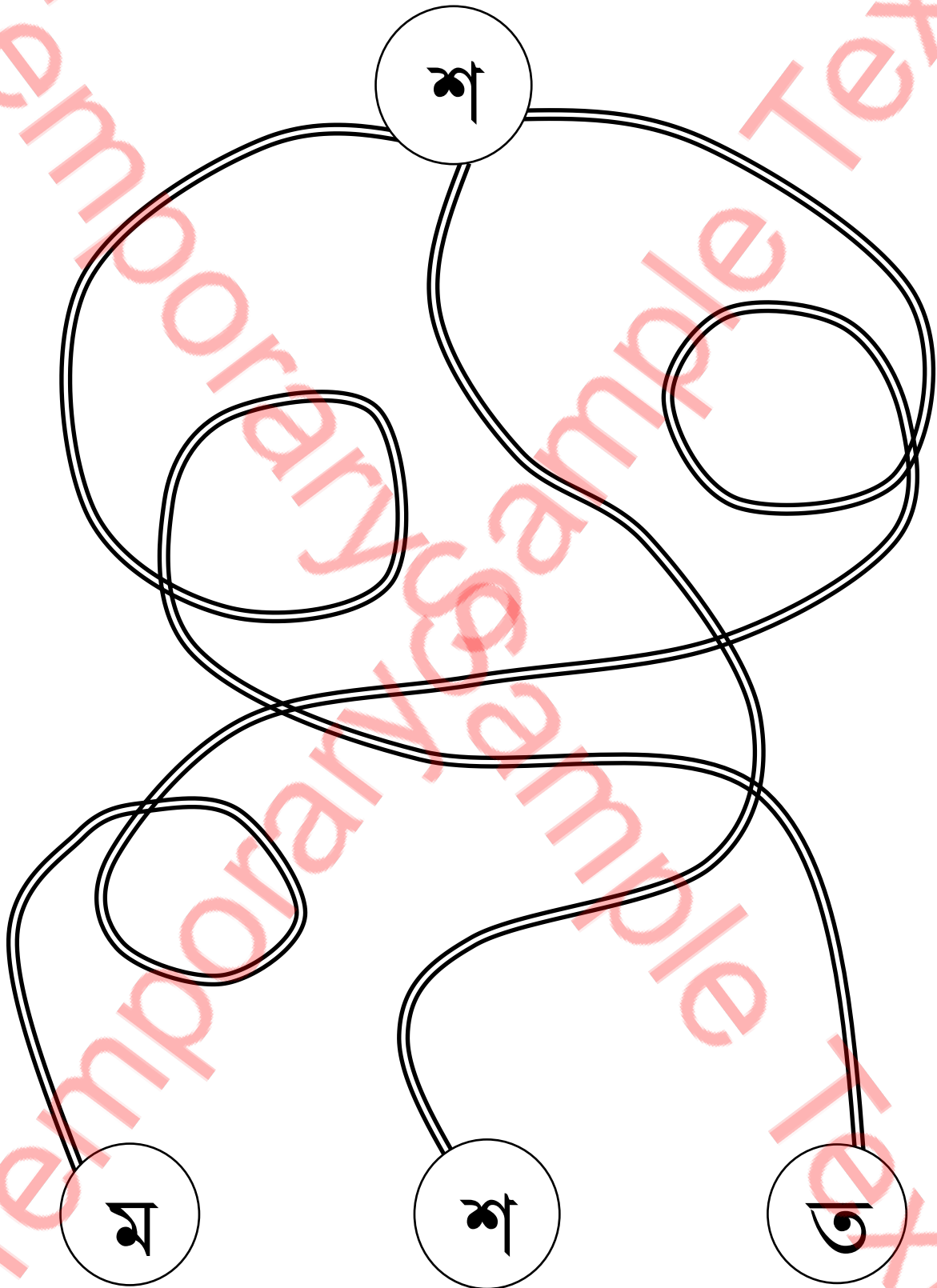

Student Name: \_\_\_\_\_

Verified By: \_\_\_\_\_

Class: \_\_\_\_\_

Date: \_\_\_\_\_



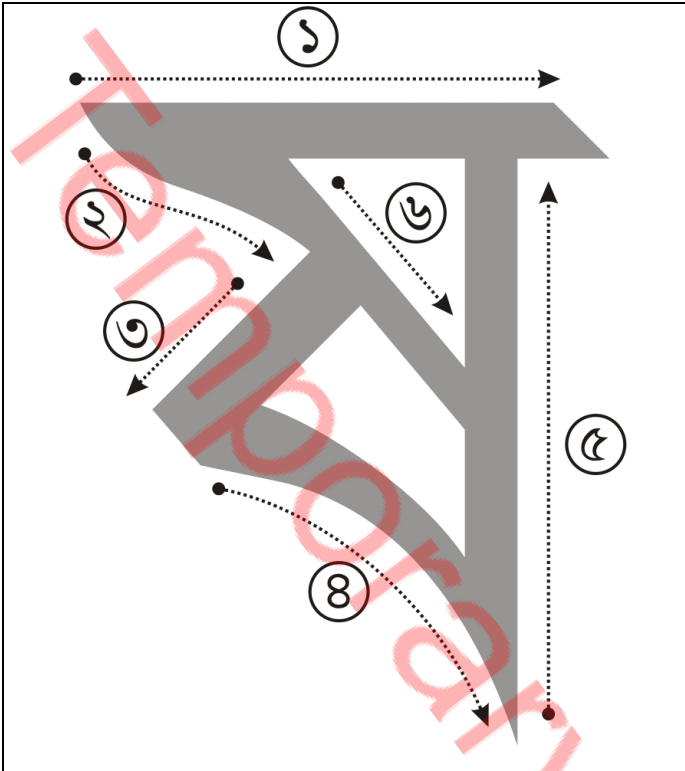

Follow the above steps

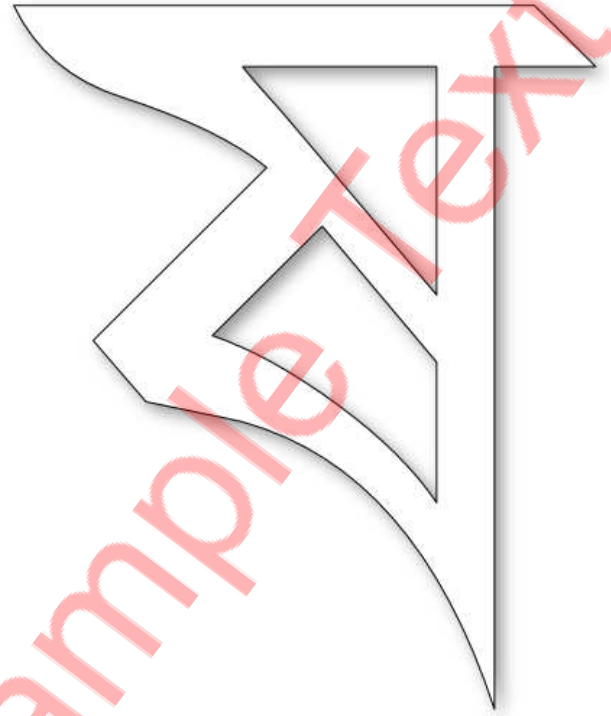

Colour it accordingly

ক	খ	গ	ঘ	ঙ	চ	ছ	জ
ঝ	ঞ	ট	ঠ	ড	ঢ	ণ	ত
থ	দ	ধ	ন	প	ফ	ব	ভ
ম	য	র	ল	শ	ষ	স	
হ	ক্ষ	ড়	ঢ়	য়	ং	ঃ	ঁ

Student Name: \_\_\_\_\_

Verified By: \_\_\_\_\_

Class: \_\_\_\_\_

Date: \_\_\_\_\_

## Trace It



Student Name: \_\_\_\_\_

Verified By: \_\_\_\_\_

Class: \_\_\_\_\_

Date: \_\_\_\_\_

# Trace it



Student Name: \_\_\_\_\_

Verified By: \_\_\_\_\_

Class: \_\_\_\_\_

Date: \_\_\_\_\_

Write it

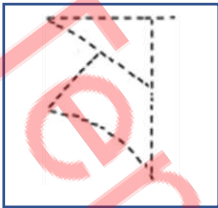
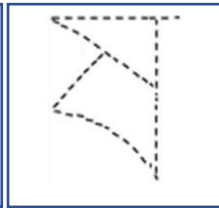
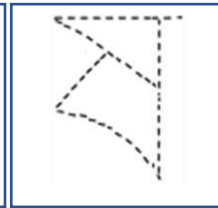
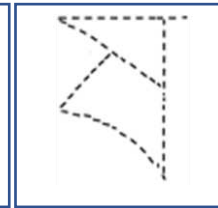
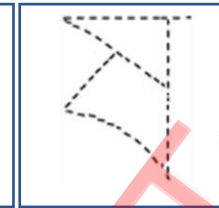
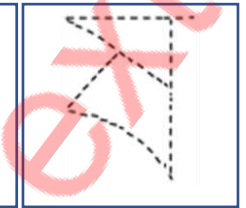
Student Name: \_\_\_\_\_

Verified By: \_\_\_\_\_

Class: \_\_\_\_\_

Date: \_\_\_\_\_

Copy Colour

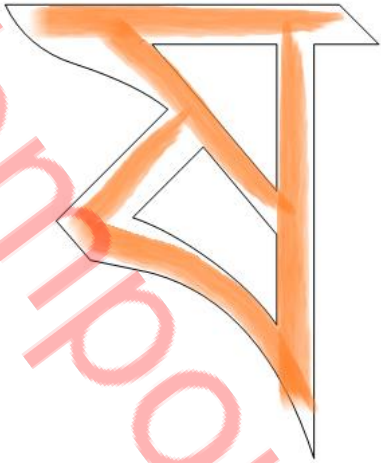

Colour it



Write it

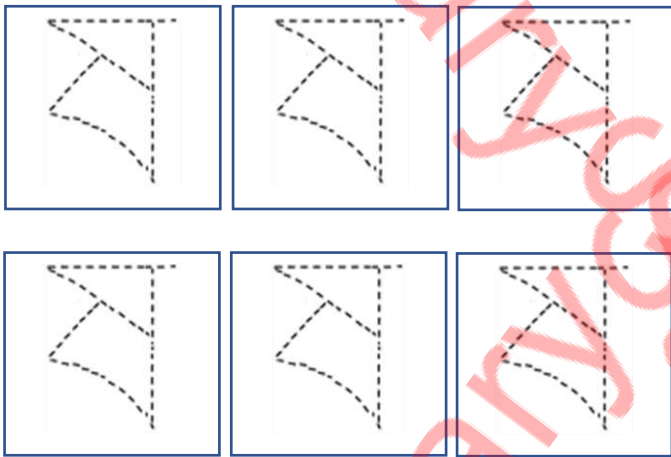

Find it

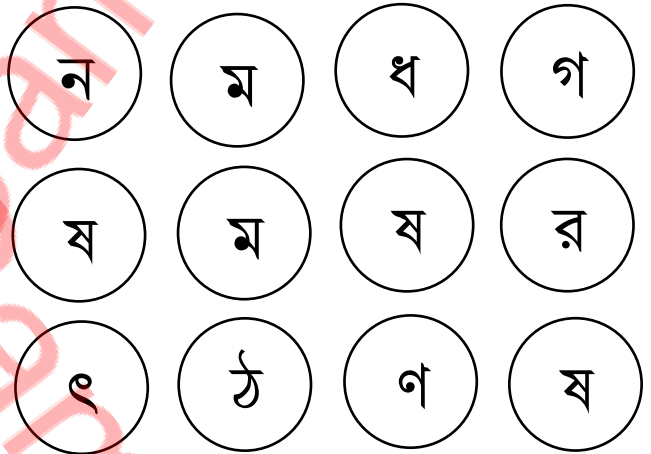

Connect the circle

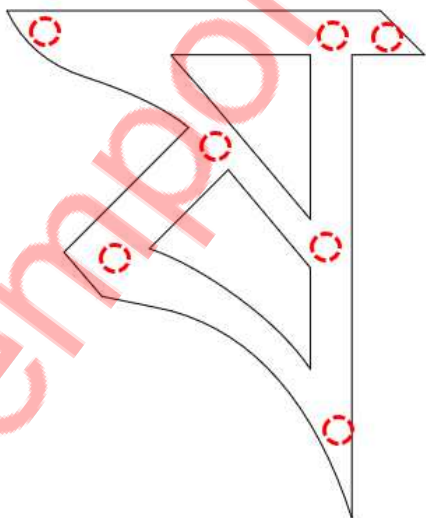

Do it

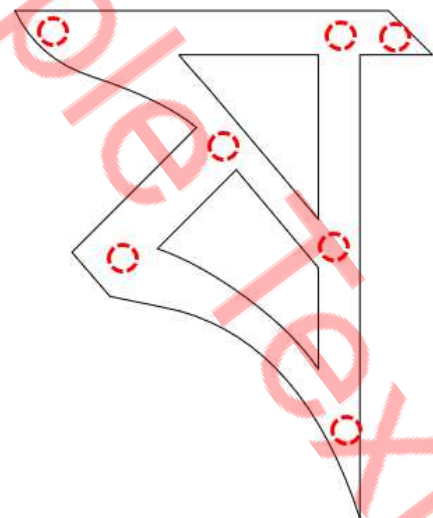

Student Name: \_\_\_\_\_

Verified By: \_\_\_\_\_

Class: \_\_\_\_\_

Date: \_\_\_\_\_

## Pick the Path Find the Correct Alphabet

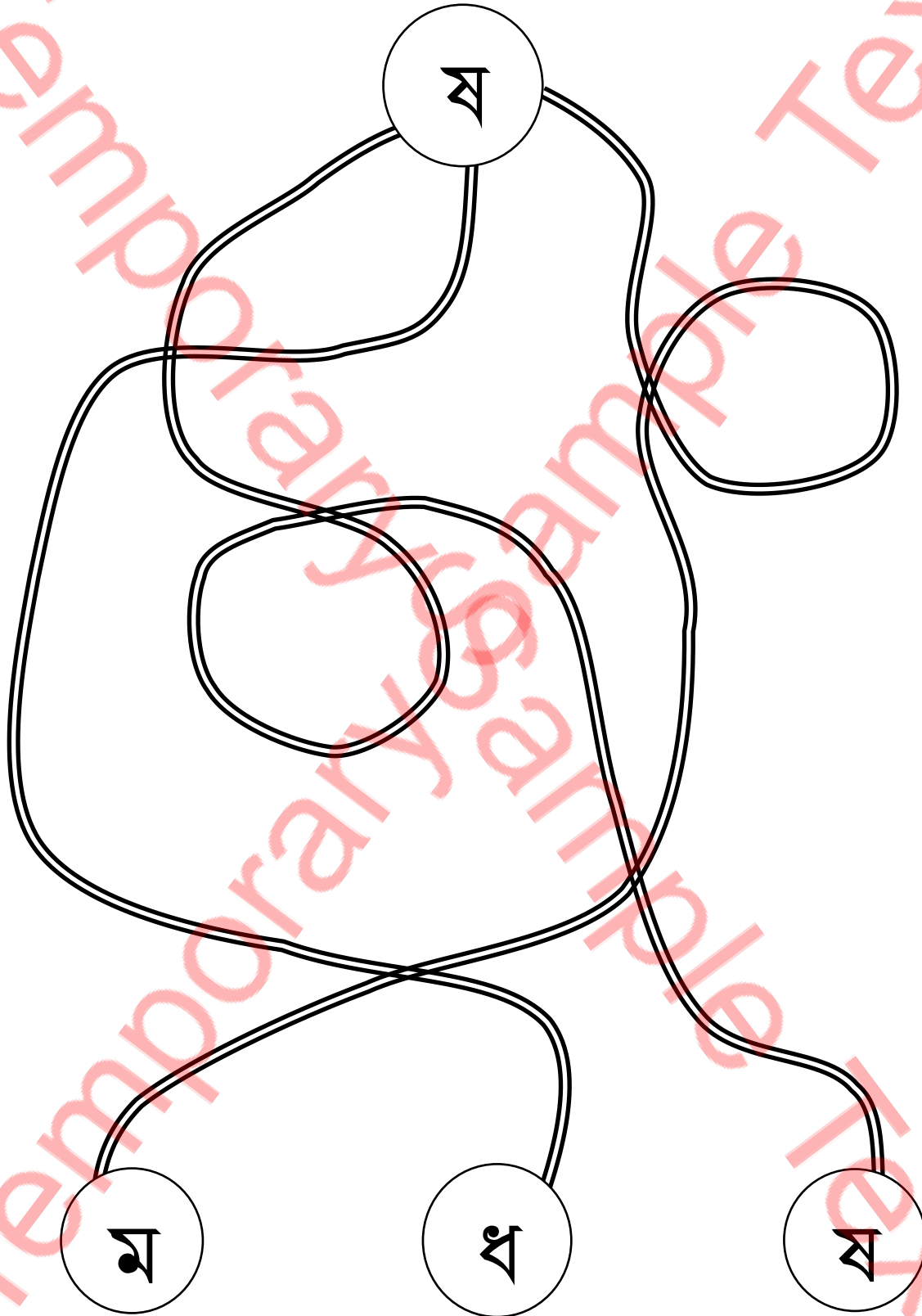

Student Name: \_\_\_\_\_

Verified By: \_\_\_\_\_

Class: \_\_\_\_\_

Date: \_\_\_\_\_



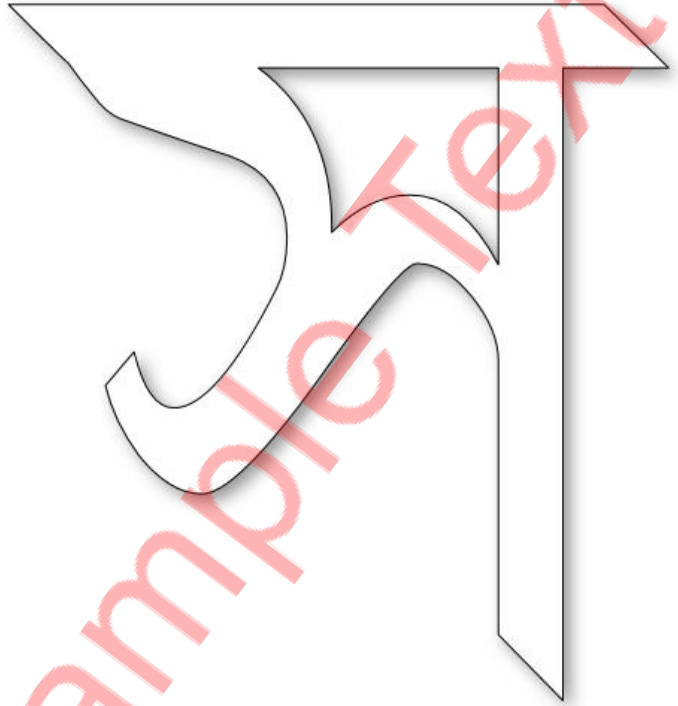
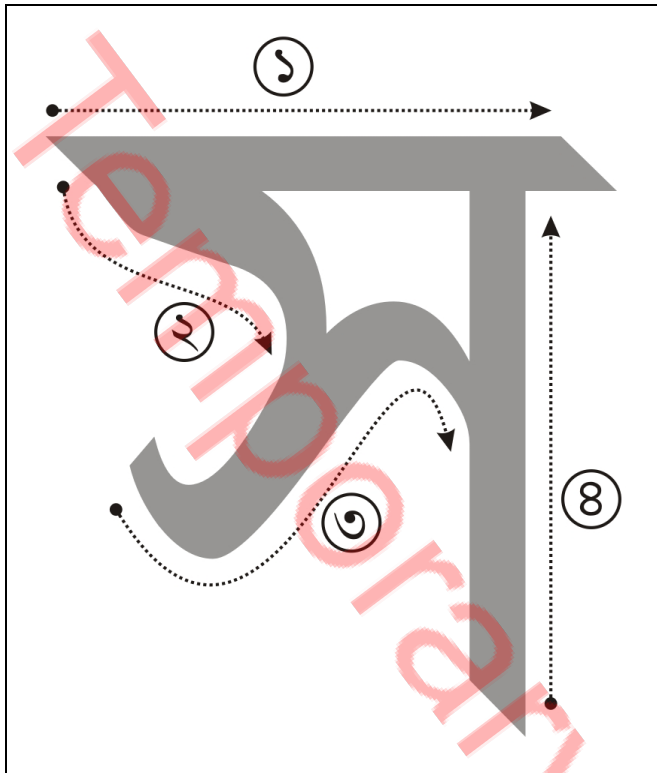

Follow the above steps

Colour it accordingly

ক	খ	গ	ঘ	ঙ	চ	ছ	জ
ঝ	ঞ	ট	ঠ	ড	ঢ	ণ	ত
থ	দ	ধ	ন	প	ফ	ব	ভ
ম	য	ষ	র	শ	ষ	স	
হ	ক্ষ	ড়	ঢ়	য়	ং	ঃ	ঁ

Student Name: \_\_\_\_\_

Verified By: \_\_\_\_\_

Class: \_\_\_\_\_

Date: \_\_\_\_\_

## Trace It

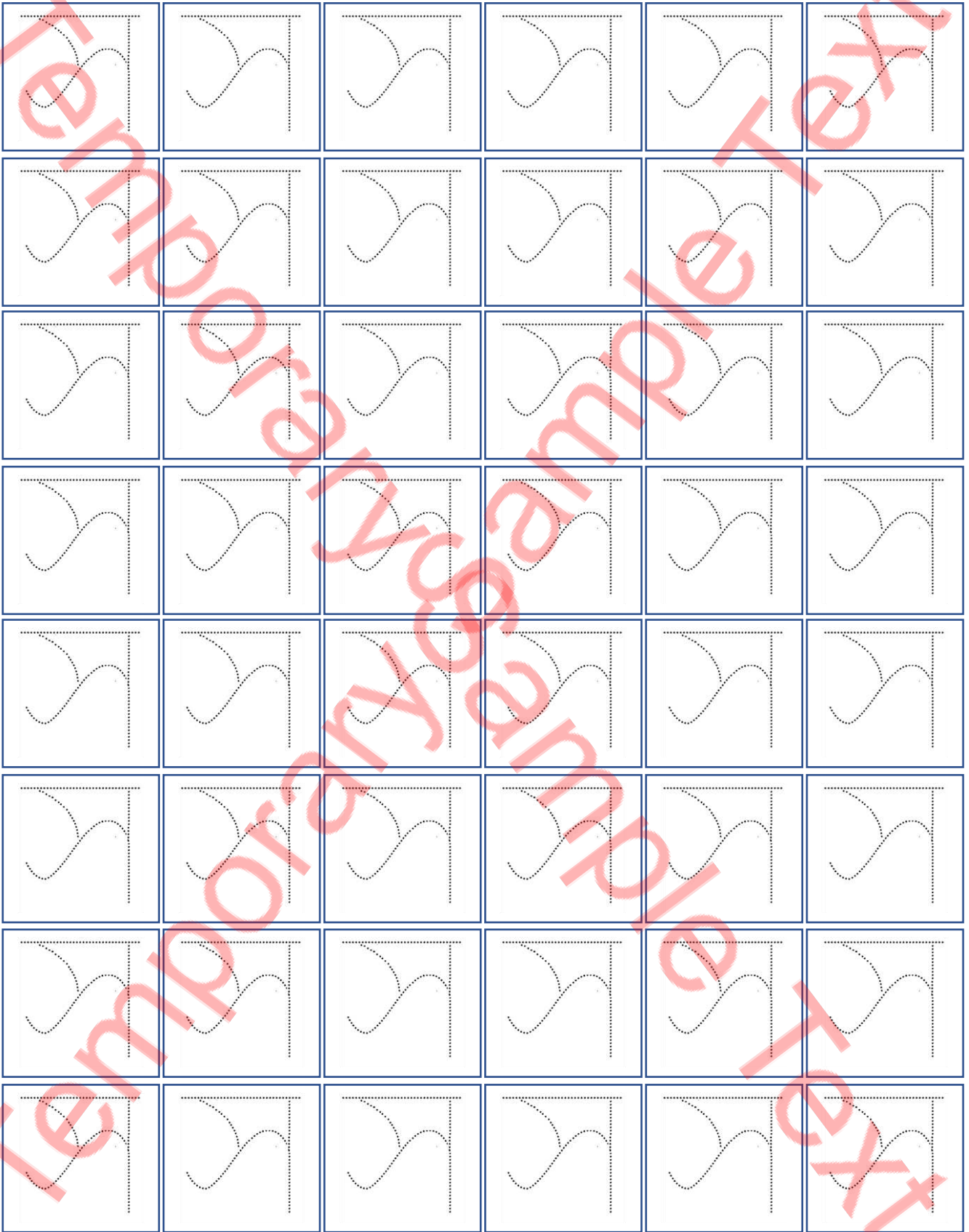

Student Name: \_\_\_\_\_

Verified By: \_\_\_\_\_

Class: \_\_\_\_\_

Date: \_\_\_\_\_

# Trace it



Student Name: \_\_\_\_\_

Verified By: \_\_\_\_\_

Class: \_\_\_\_\_

Date: \_\_\_\_\_

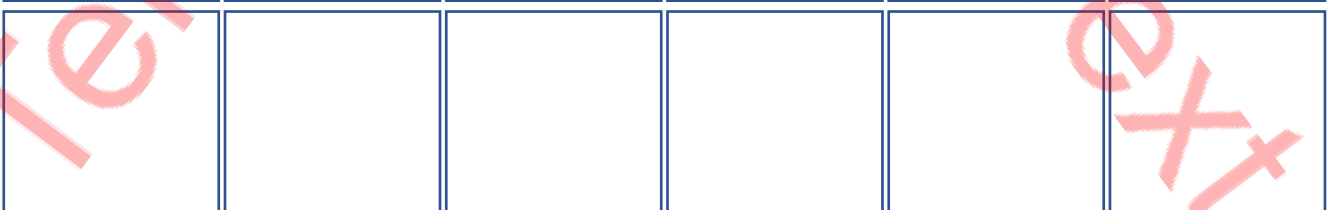
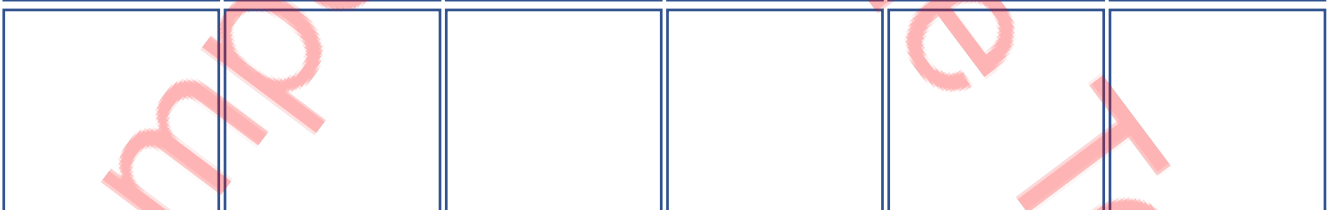
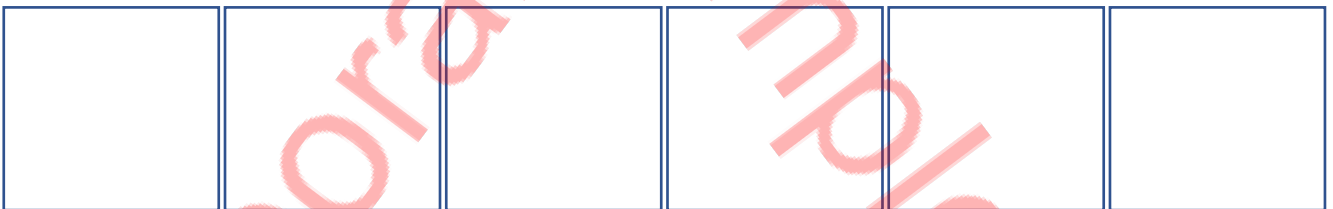
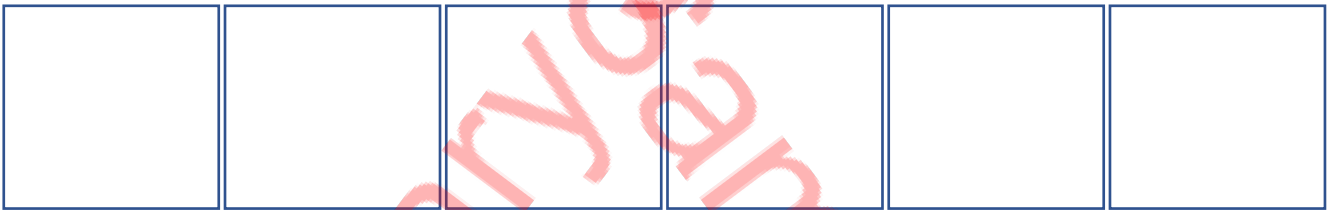
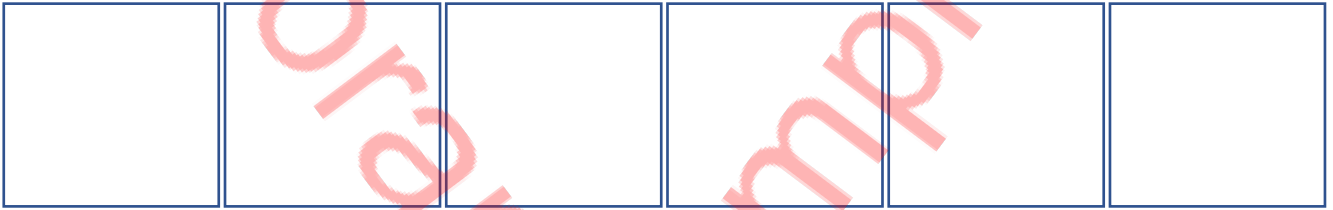
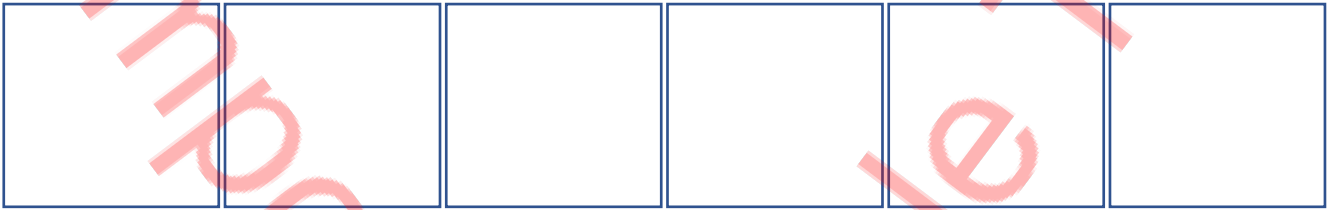
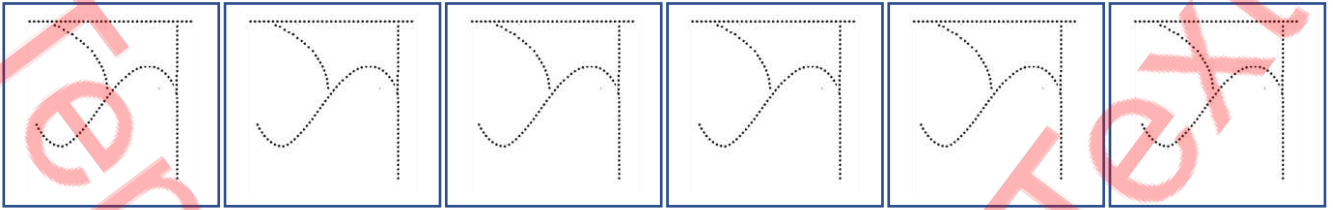
## Write it



Student Name: \_\_\_\_\_

Verified By: \_\_\_\_\_

Class: \_\_\_\_\_

Date: \_\_\_\_\_

Copy Colour

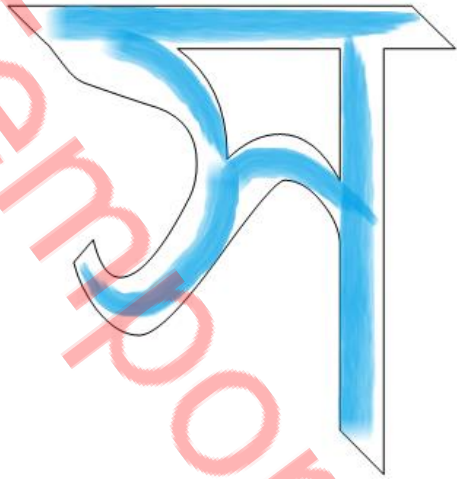

Colour it

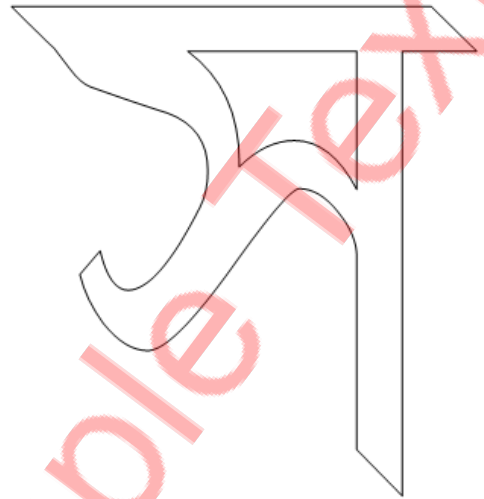

Write it

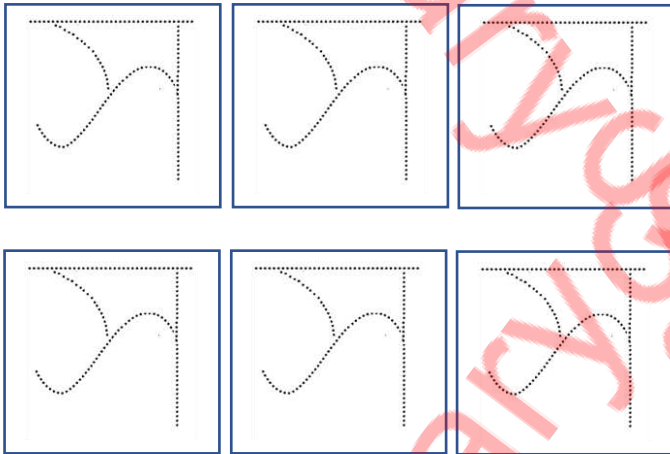

Find it

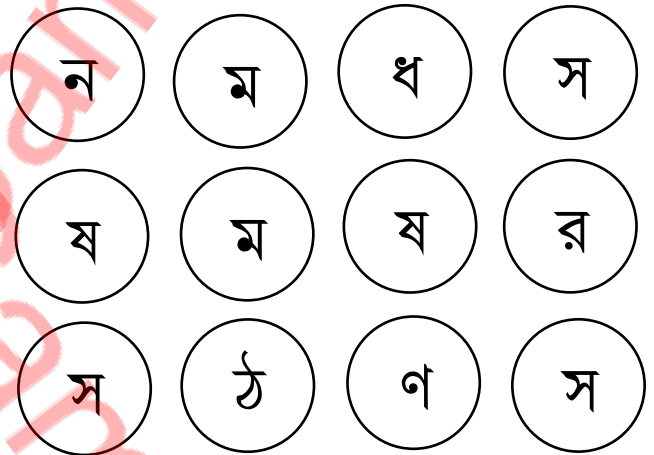

Connect the circle

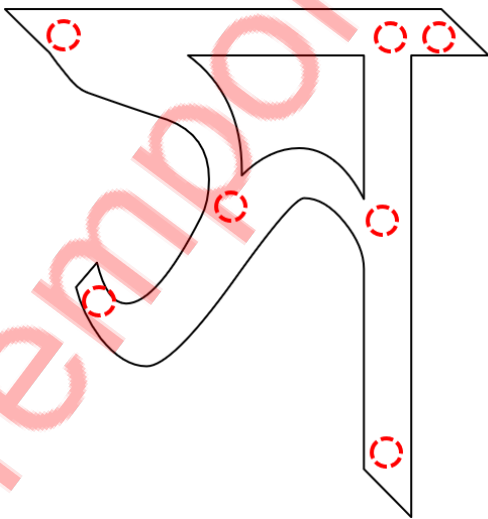

Do it

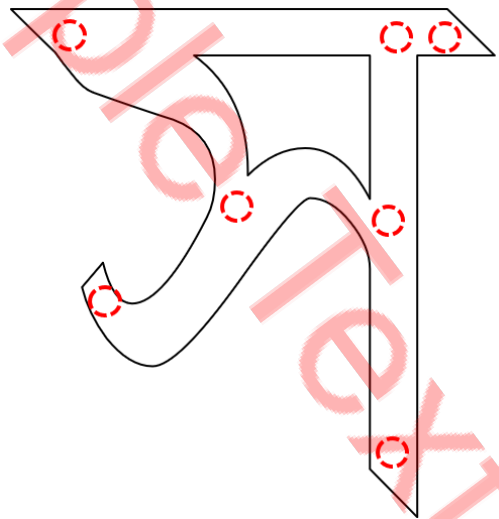

Student Name: \_\_\_\_\_

Verified By: \_\_\_\_\_

Class: \_\_\_\_\_

Date: \_\_\_\_\_

# Pick the Path Find the Correct Alphabet

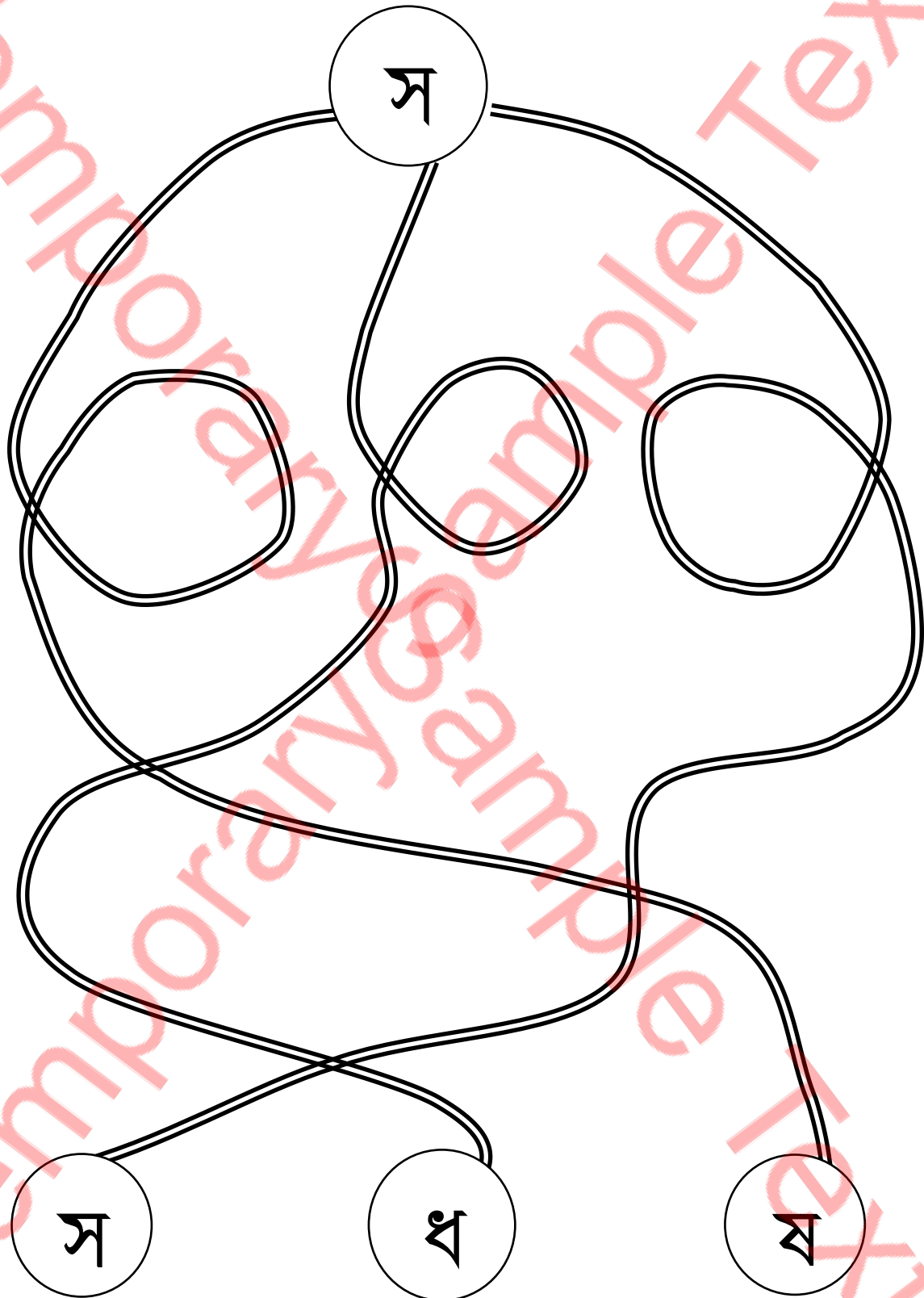

Student Name: \_\_\_\_\_

Verified By: \_\_\_\_\_

Class: \_\_\_\_\_

Date: \_\_\_\_\_



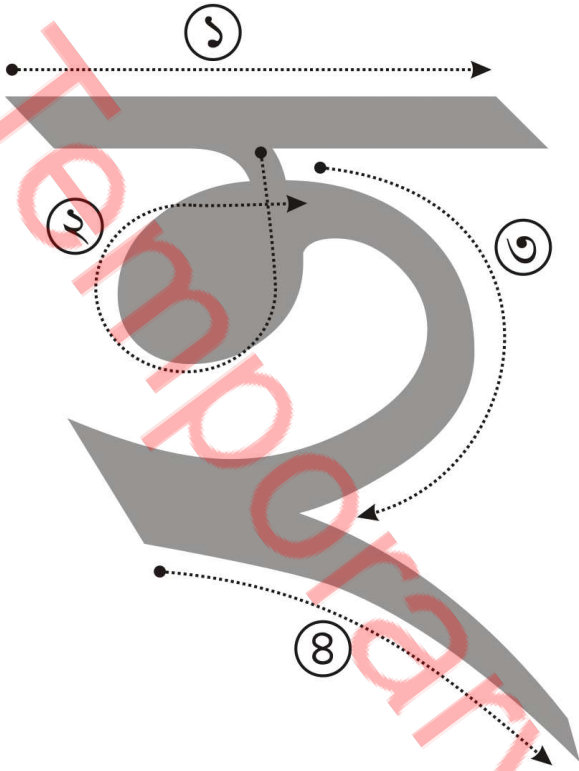

Follow the above steps

Colour it accordingly

ক	খ	গ	ঘ	ঙ	চ	ছ	জ
ঝ	ঞ	ট	ঠ	ড	ঢ	ণ	ত
থ	দ	ধ	ন	প	ফ	ব	ভ
ম	য	র	ল	শ	ষ	স	
হ	ক্ষ	ড়	ঢ়	য়	ং	ঃ	ঁ

Student Name: \_\_\_\_\_

Verified By: \_\_\_\_\_

Class: \_\_\_\_\_

Date: \_\_\_\_\_

## Trace It



Student Name: \_\_\_\_\_

Verified By: \_\_\_\_\_

Class: \_\_\_\_\_

Date: \_\_\_\_\_

# Trace it



Student Name: \_\_\_\_\_

Verified By: \_\_\_\_\_

Class: \_\_\_\_\_

Date: \_\_\_\_\_

# Write it

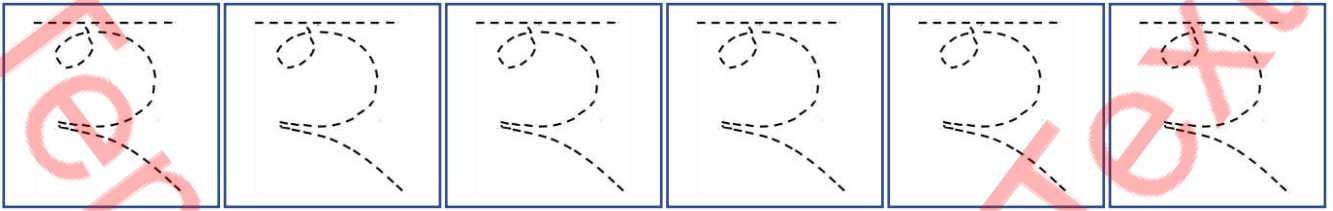



Student Name: \_\_\_\_\_

Verified By: \_\_\_\_\_

Class: \_\_\_\_\_

Date: \_\_\_\_\_

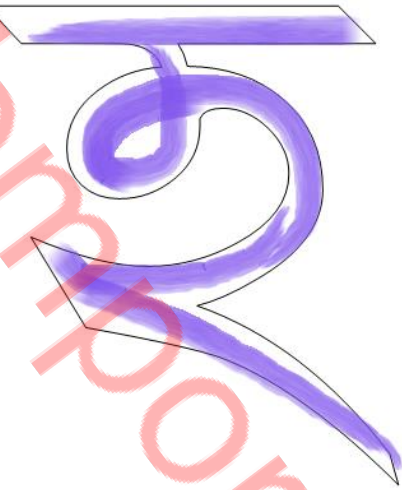
Copy Colour



Colour it

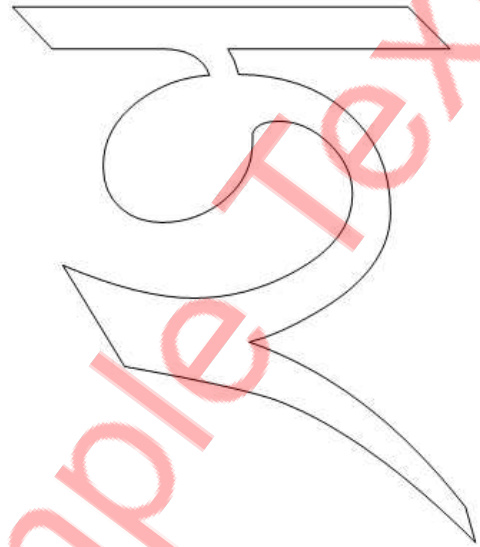

Write it

Find it

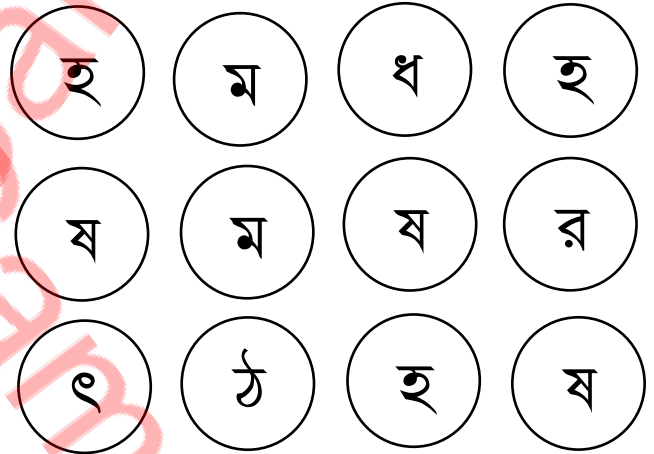
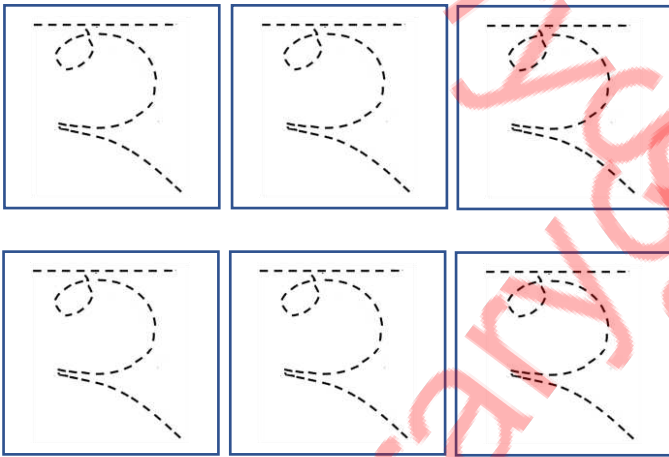

Connect the circle

Do it

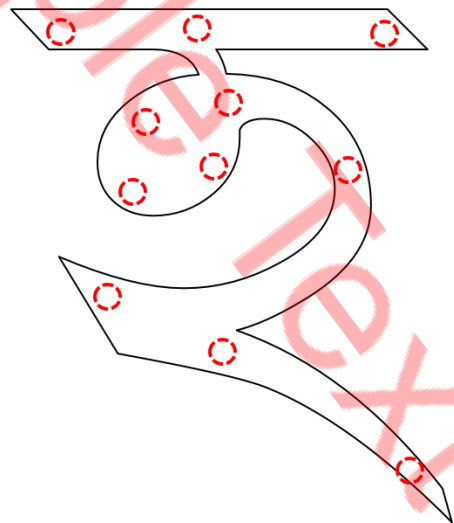
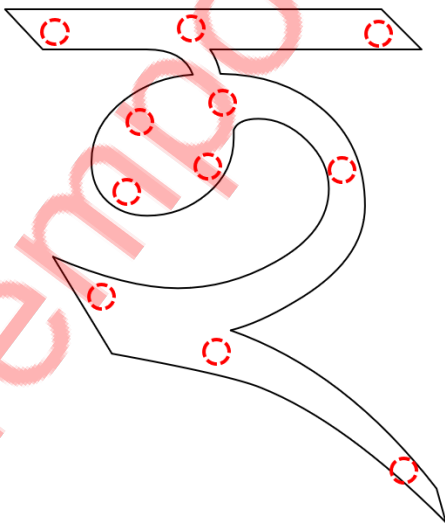

Student Name: \_\_\_\_\_

Verified By: \_\_\_\_\_

Class: \_\_\_\_\_

Date: \_\_\_\_\_

# Pick the Path Find the Correct Alphabet

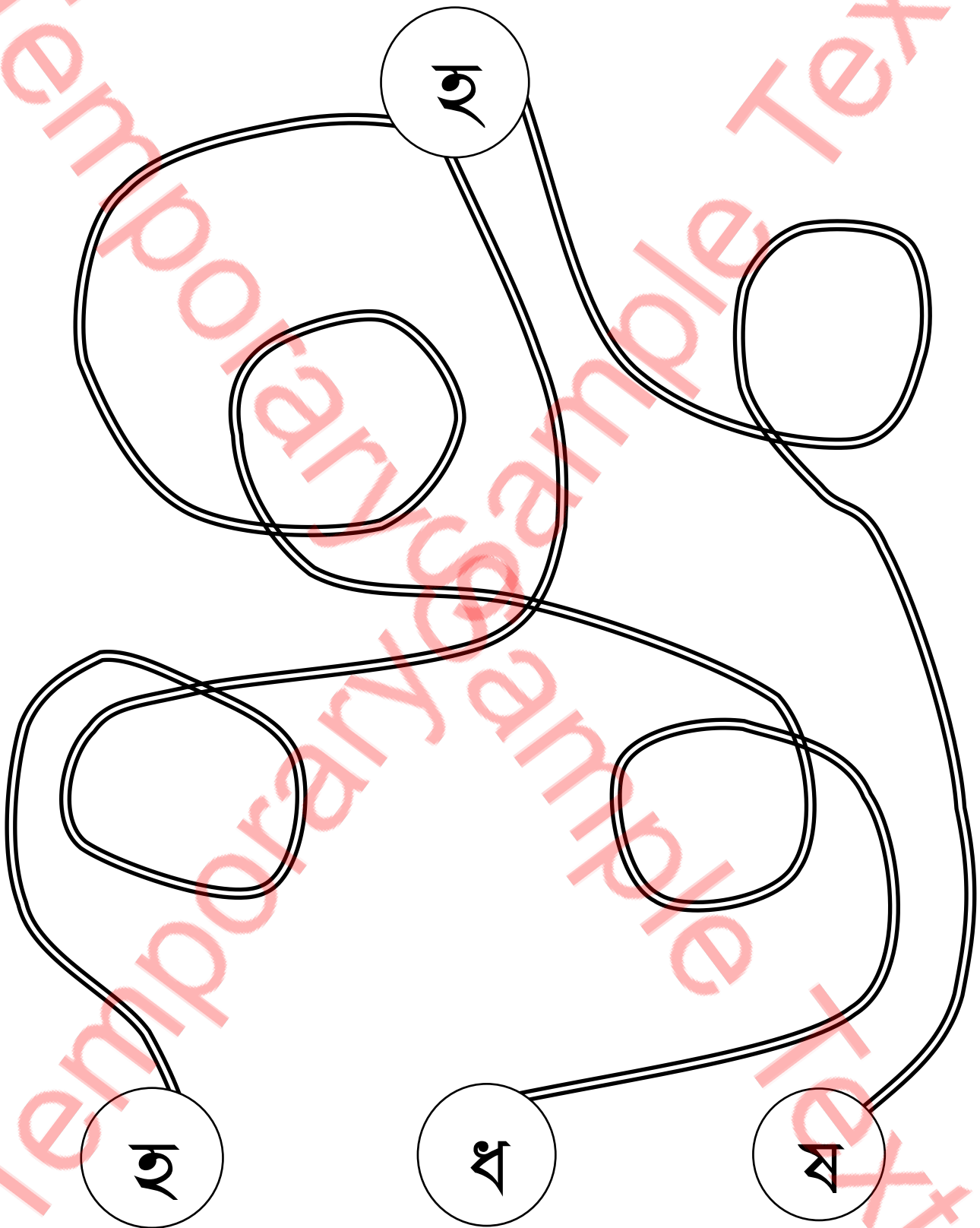

Student Name: \_\_\_\_\_

Verified By: \_\_\_\_\_

Class: \_\_\_\_\_

Date: \_\_\_\_\_



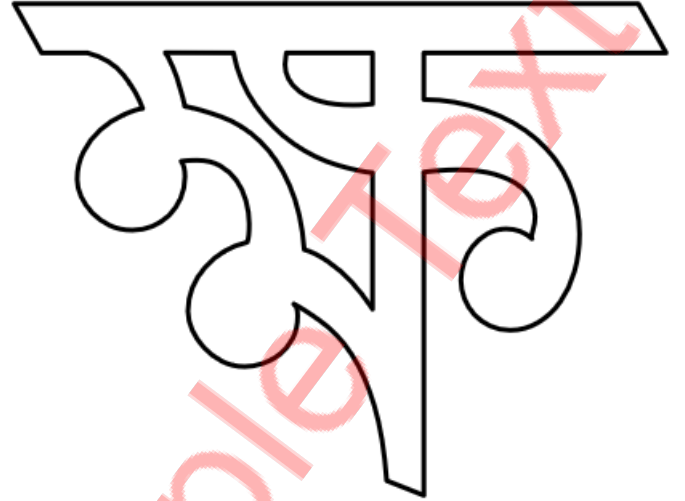
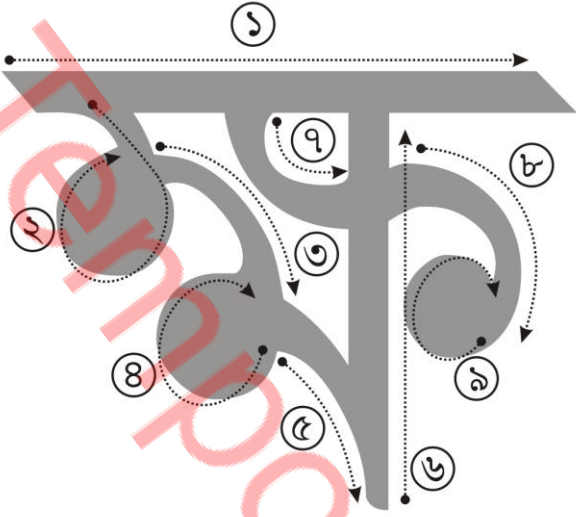

Follow the above steps

Colour it accordingly

ক	খ	গ	ঘ	ঙ	চ	ছ	জ
ঝ	ঞ	ট	ঠ	ড	ঢ	ণ	ত
থ	দ	ধ	ন	প	ফ	ব	ভ
ম	য	ষ	র	শ	ষ	স	
হ	ক্ষ	জ	ড	য়	ং	ঃ	ঁ

Student Name: \_\_\_\_\_

Verified By: \_\_\_\_\_

Class: \_\_\_\_\_

Date: \_\_\_\_\_

## Trace It













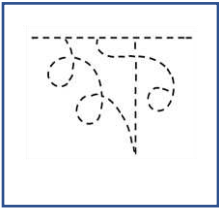
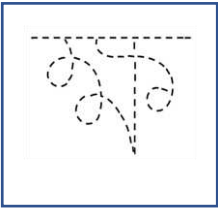
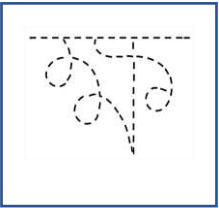
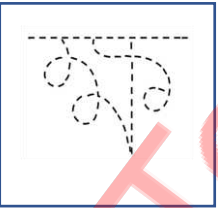

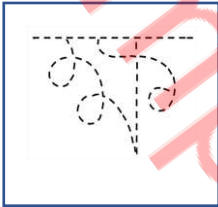
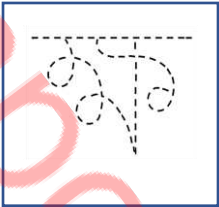
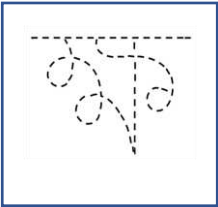
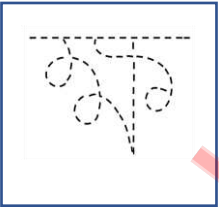

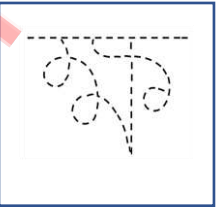
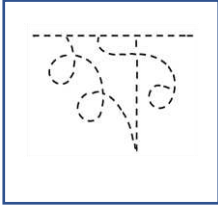
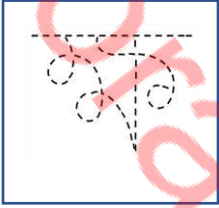
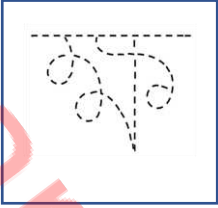
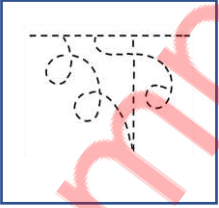
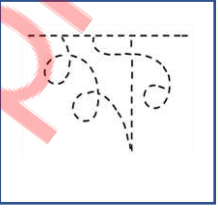
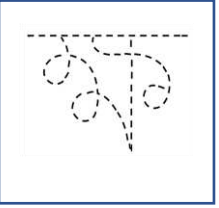
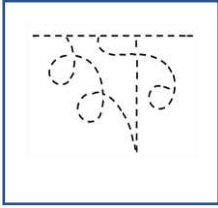
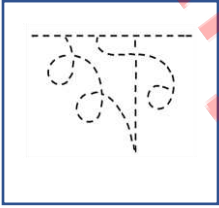
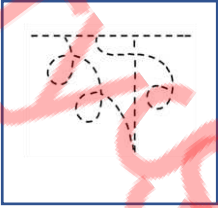
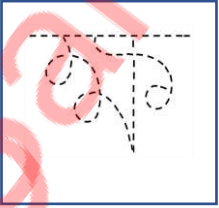

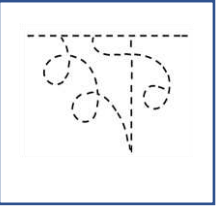
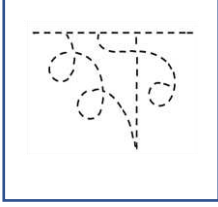
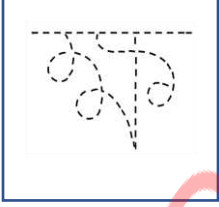

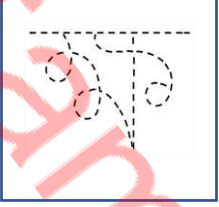
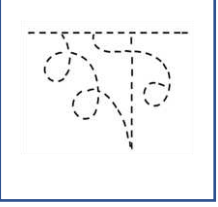
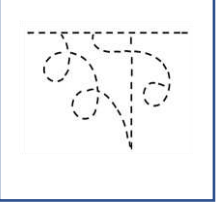
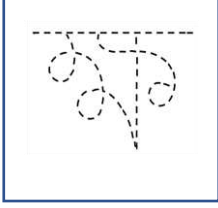

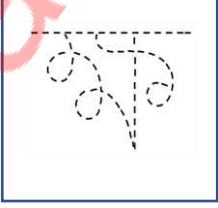
Student Name: \_\_\_\_\_

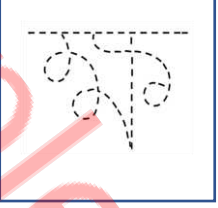
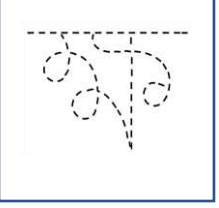
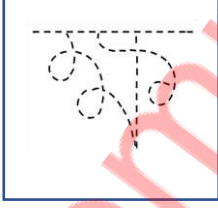
Verified By: \_\_\_\_\_

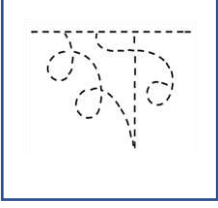
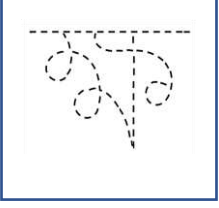
Class: \_\_\_\_\_

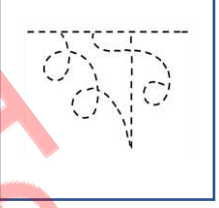
Date: \_\_\_\_\_

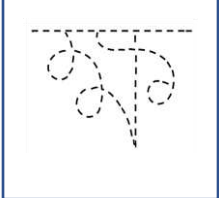
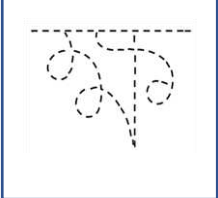
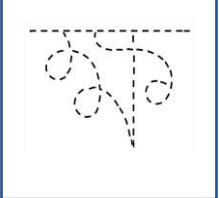
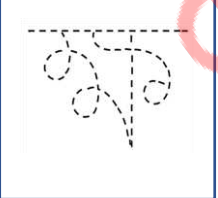
# Trace it











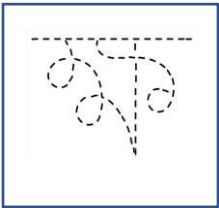
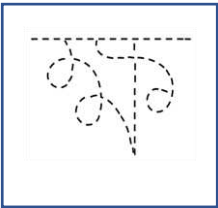
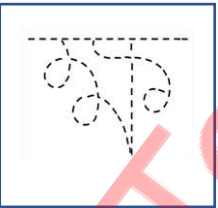

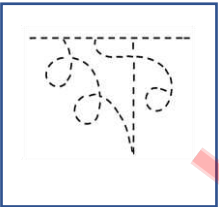
Student Name: \_\_\_\_\_

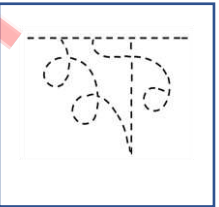
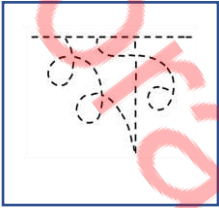
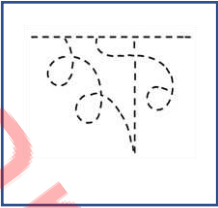
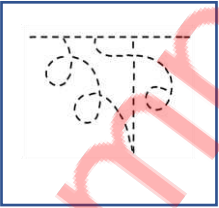
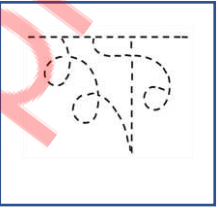
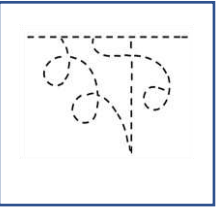
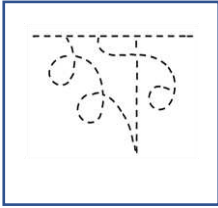
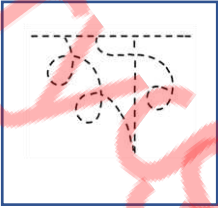
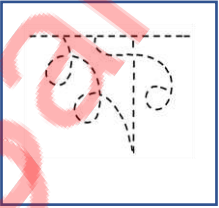
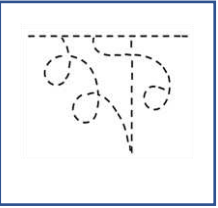
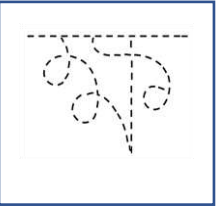
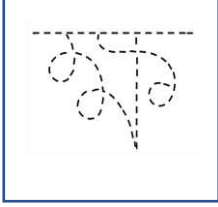
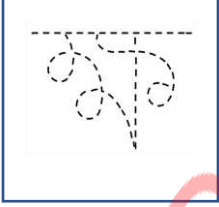
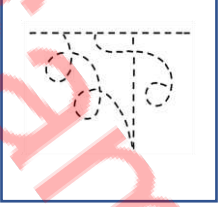
Verified By: \_\_\_\_\_

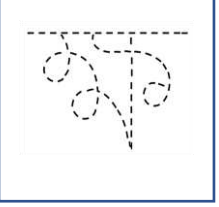
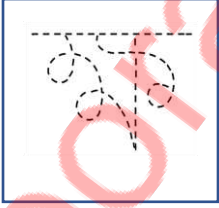
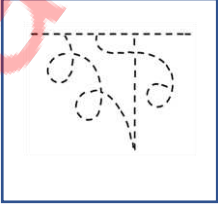
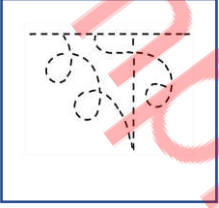
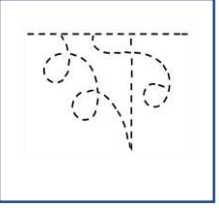
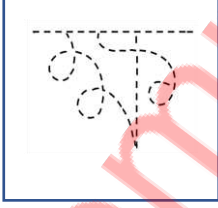
Class: \_\_\_\_\_

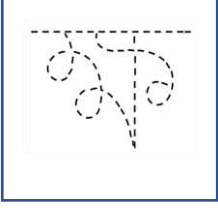
Date: \_\_\_\_\_

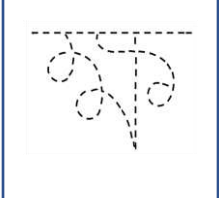
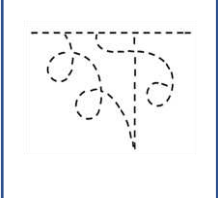
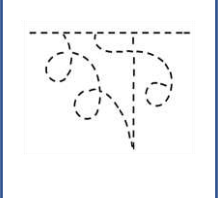
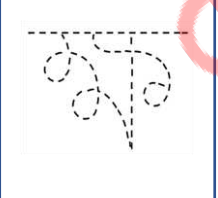
Write it

Student Name: \_\_\_\_\_

Verified By: \_\_\_\_\_

Class: \_\_\_\_\_

Date: \_\_\_\_\_



Copy Colour

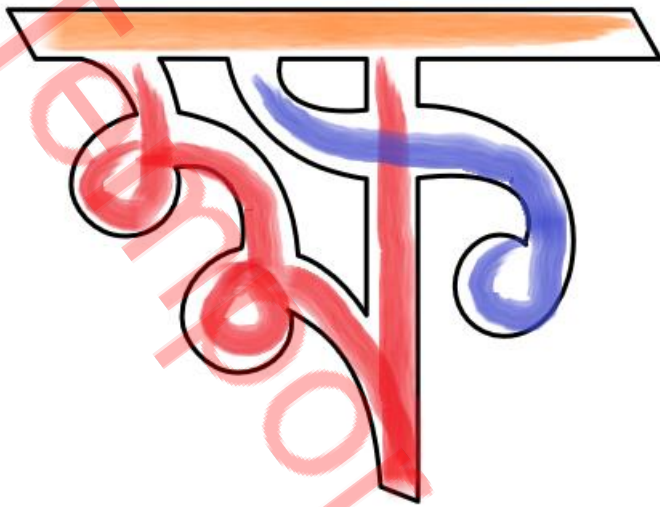

Colour it

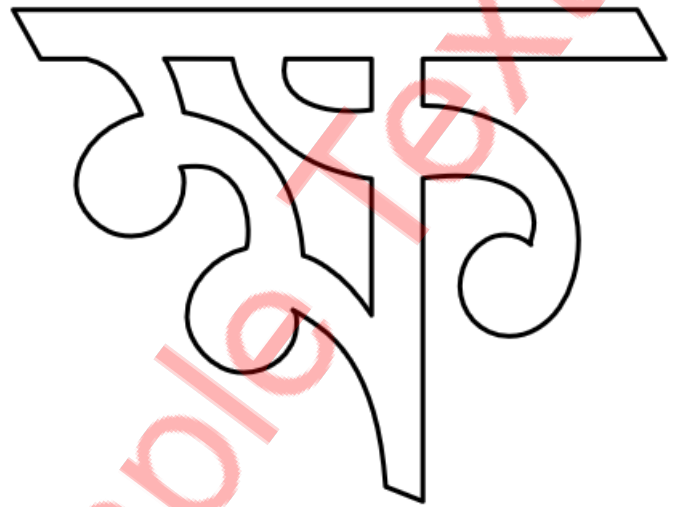

Write it

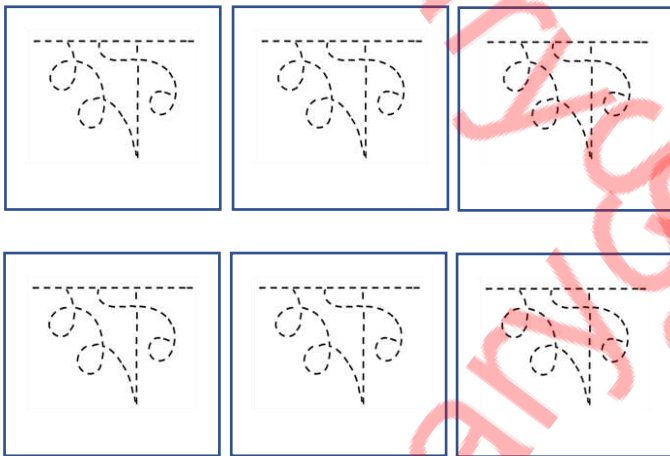

Find it

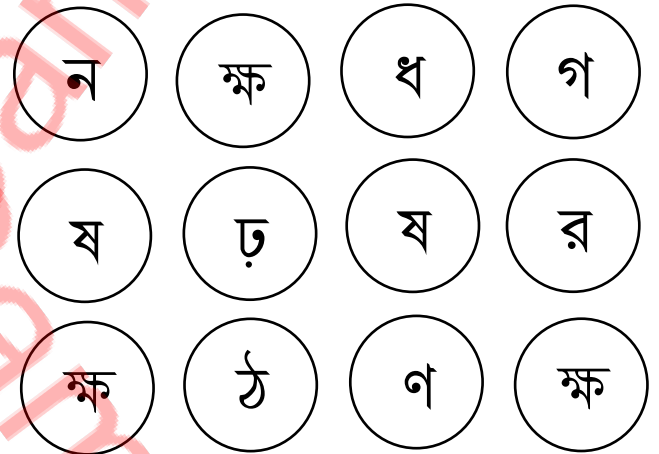

Connect the circle

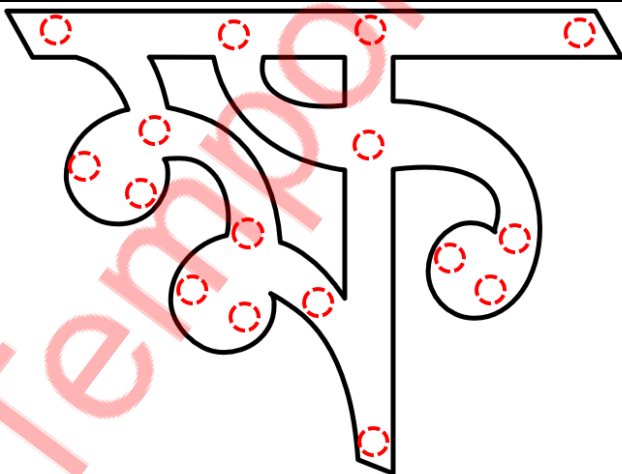

Do it

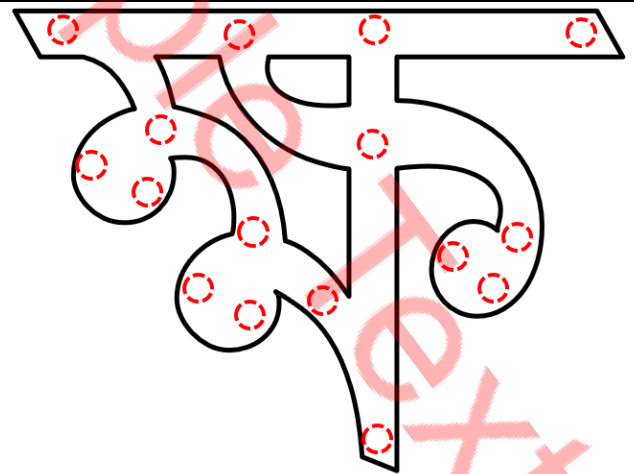

Student Name: \_\_\_\_\_

Verified By: \_\_\_\_\_

Class: \_\_\_\_\_

Date: \_\_\_\_\_

# Pick the Path Find the Correct Alphabet

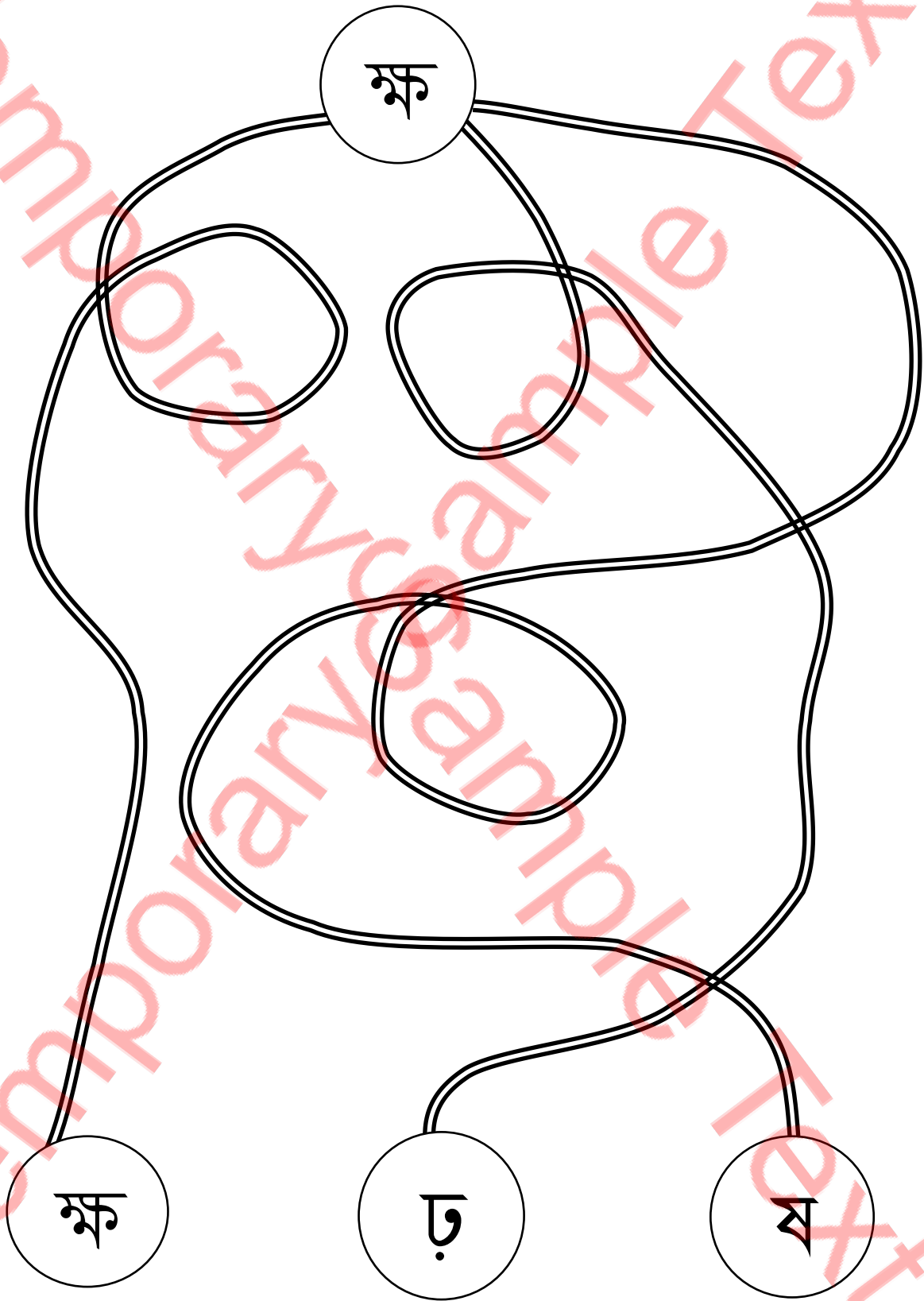

Student Name: \_\_\_\_\_

Verified By: \_\_\_\_\_

Class: \_\_\_\_\_

Date: \_\_\_\_\_



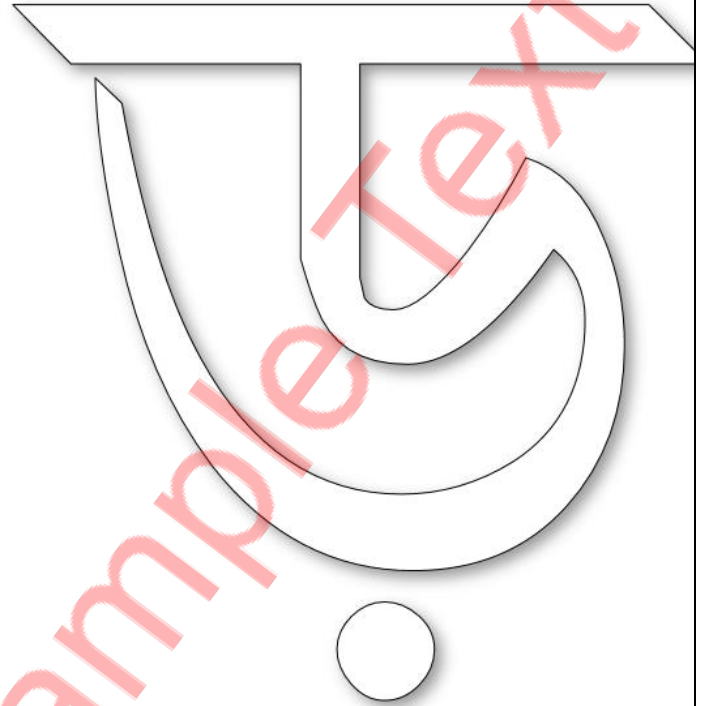
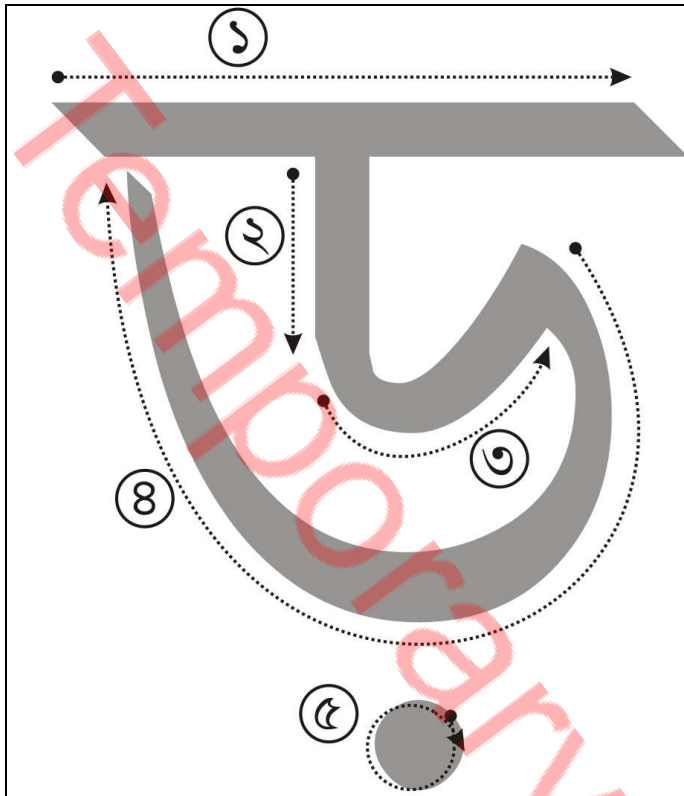

Follow the above steps

Colour it accordingly

ক	খ	গ	ঘ	ঙ	চ	ছ	জ
ঝ	ঞ	ট	ঠ	ড	ঢ	ণ	ত
থ	দ	ধ	ন	প	ফ	ব	ভ
ম	য	ষ	র	ৱ	শ	ষ	স
হ	ক্ষ	ড়	ড়	য়	ং	ঃ	ং

Student Name: \_\_\_\_\_

Verified By: \_\_\_\_\_

Class: \_\_\_\_\_

Date: \_\_\_\_\_

# Trace It



Student Name: \_\_\_\_\_

Verified By: \_\_\_\_\_

Class: \_\_\_\_\_

Date: \_\_\_\_\_

# Trace it



Student Name: \_\_\_\_\_

Verified By: \_\_\_\_\_

Class: \_\_\_\_\_

Date: \_\_\_\_\_

# Write it

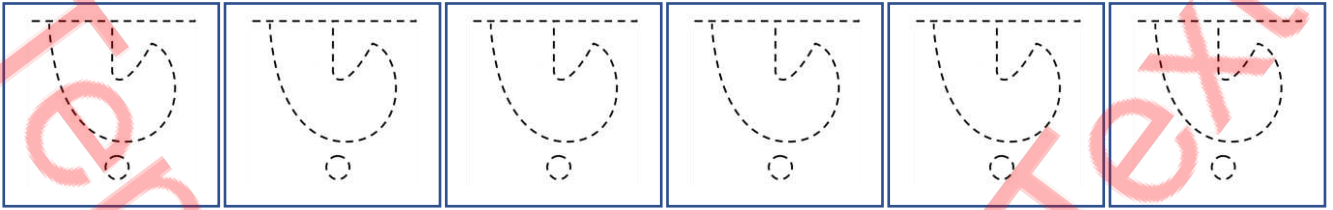



Student Name: \_\_\_\_\_

Verified By: \_\_\_\_\_

Class: \_\_\_\_\_

Date: \_\_\_\_\_

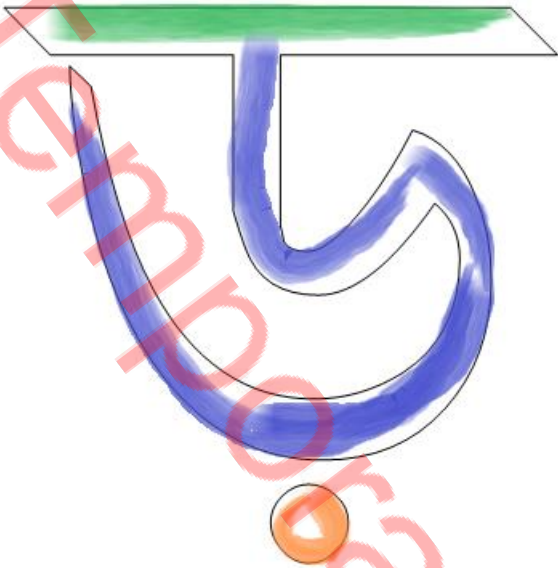
Copy Colour



Colour it

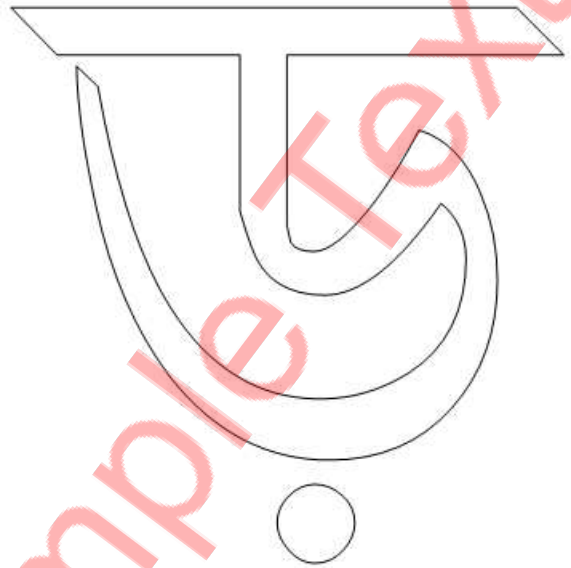

Write it

Find it

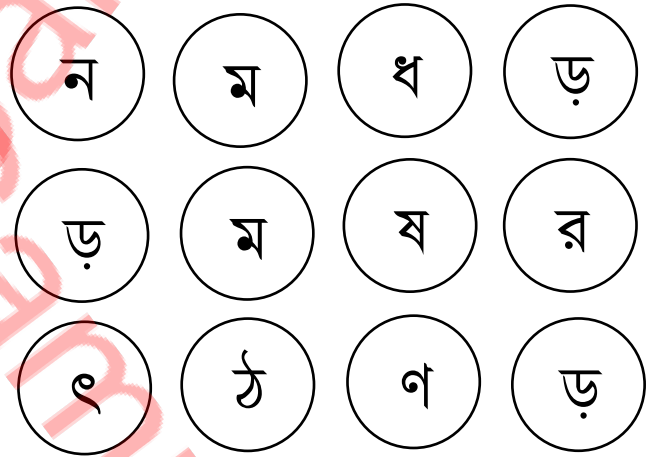
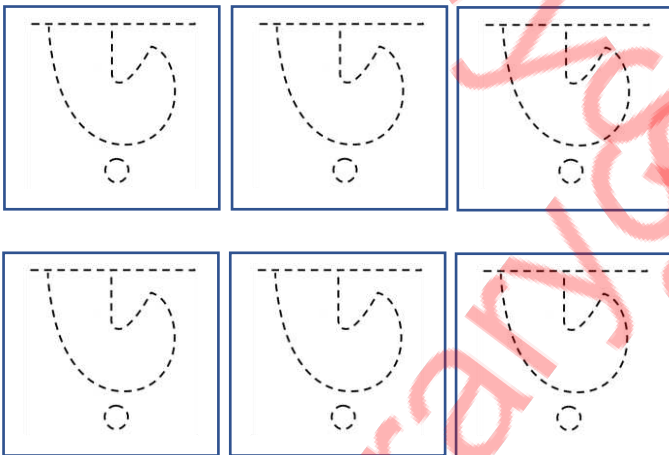

Connect the circle

Do it

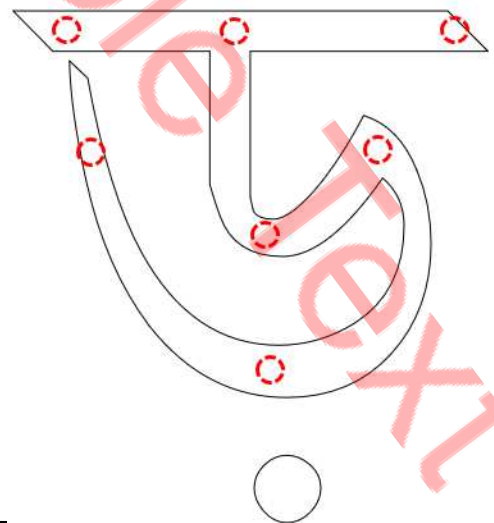
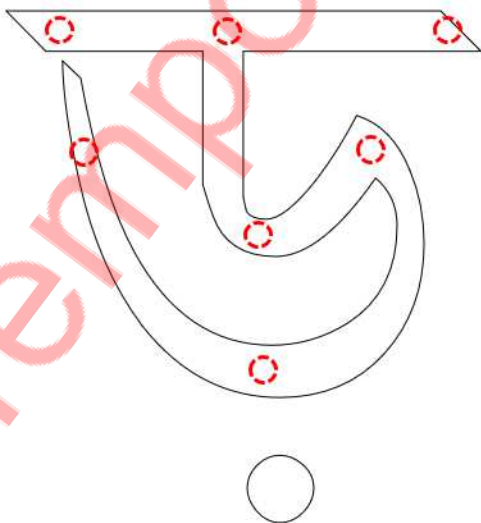

Student Name: \_\_\_\_\_

Verified By: \_\_\_\_\_

Class: \_\_\_\_\_

Date: \_\_\_\_\_

## Pick the Path Find the Correct Alphabet

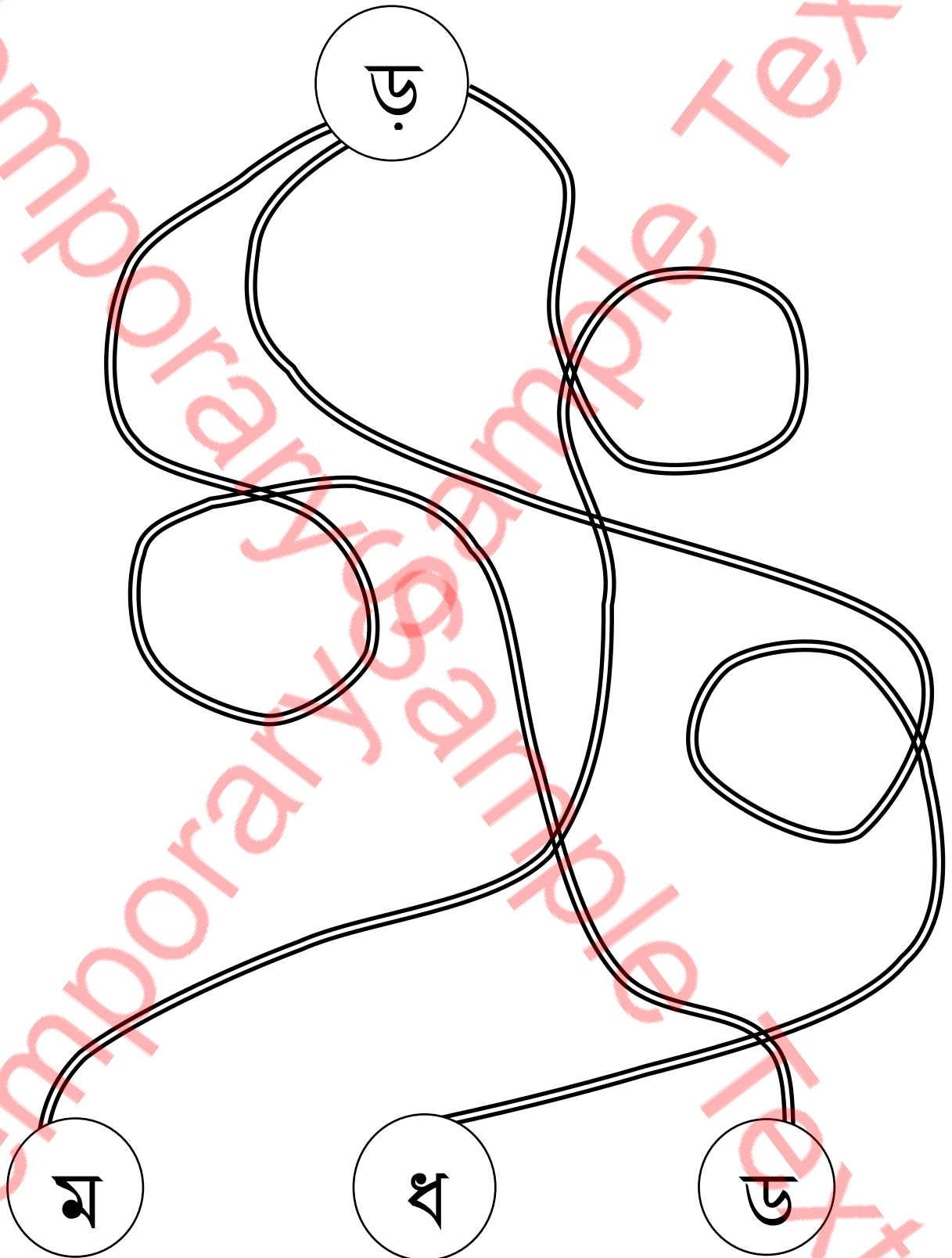

Student Name: \_\_\_\_\_

Verified By: \_\_\_\_\_

Class: \_\_\_\_\_

Date: \_\_\_\_\_



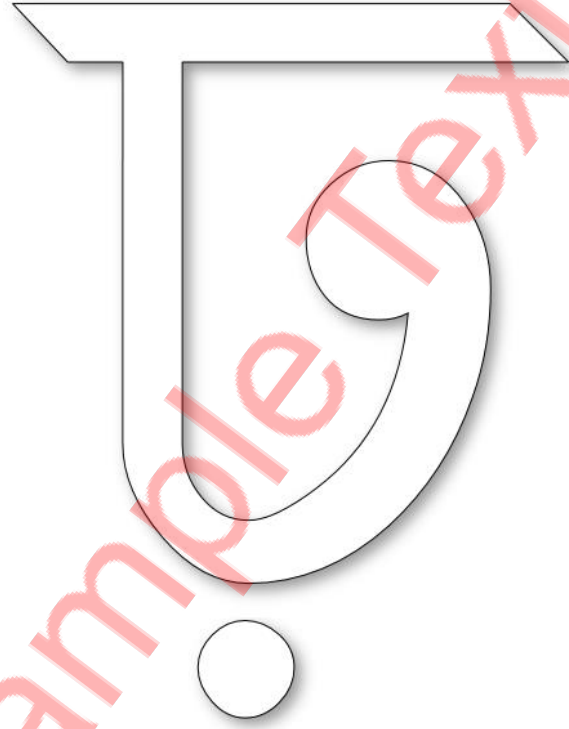
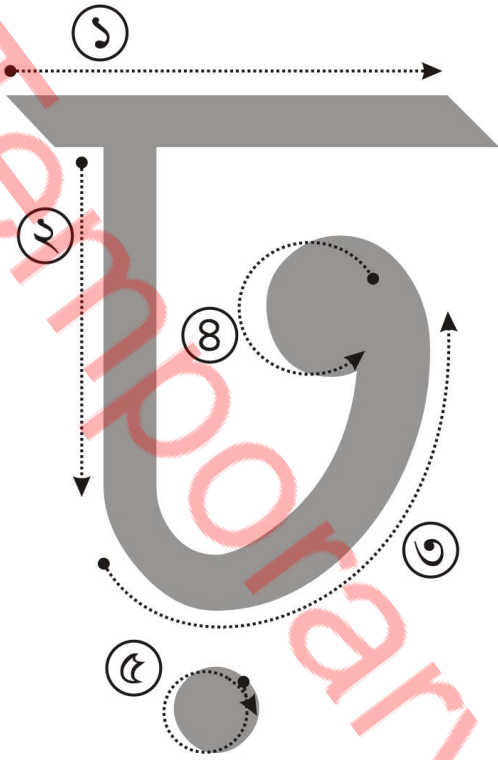

Follow the above steps

Colour it accordingly

ক	খ	গ	ঘ	ঙ	চ	ছ	জ
ঝ	ঞ	ট	ঠ	ড	ঢ	ণ	ত
থ	দ	ধ	ন	প	ফ	ব	ভ
ম	য	ষ	প্র	র	শ	ষ	স
হ	ক্ষ	ড়	ঢ়	য়	ং	ঃ	ঁ

Student Name: \_\_\_\_\_

Verified By: \_\_\_\_\_

Class: \_\_\_\_\_

Date: \_\_\_\_\_

## Trace It



Student Name: \_\_\_\_\_

Verified By: \_\_\_\_\_

Class: \_\_\_\_\_

Date: \_\_\_\_\_

# Trace it



Student Name: \_\_\_\_\_

Verified By: \_\_\_\_\_

Class: \_\_\_\_\_

Date: \_\_\_\_\_

# Write it

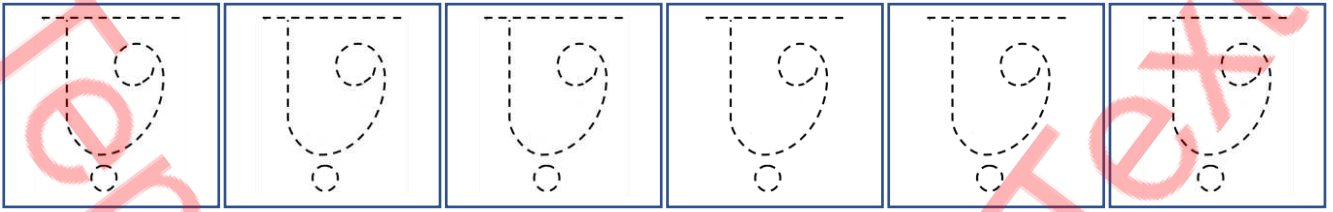



Student Name: \_\_\_\_\_

Verified By: \_\_\_\_\_

Class: \_\_\_\_\_

Date: \_\_\_\_\_

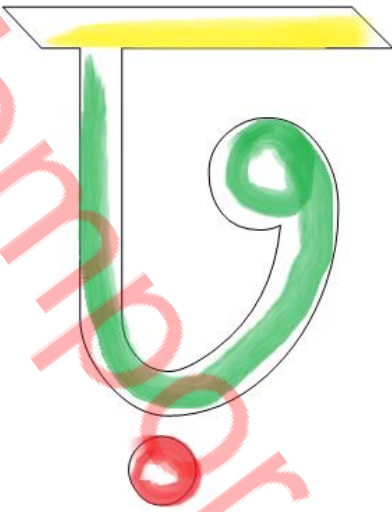
Copy Colour



Colour it



Write it

Find it

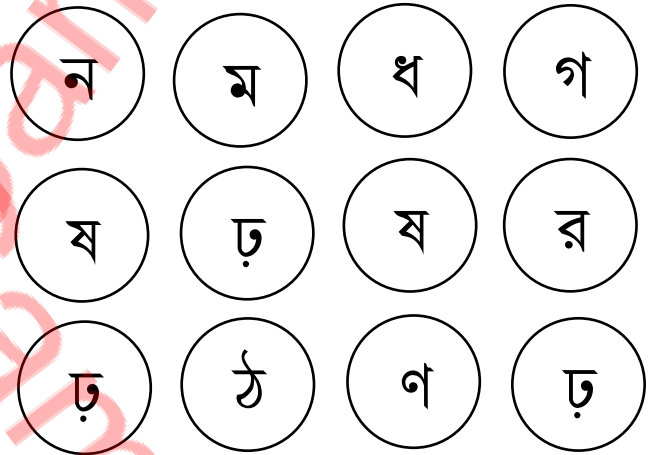
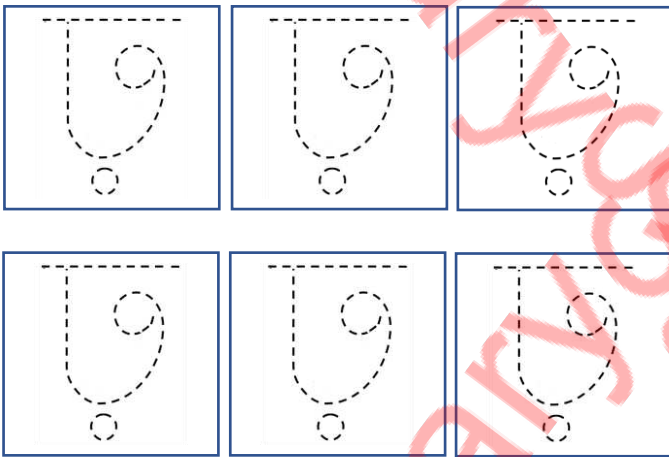

Connect the circle

Do it

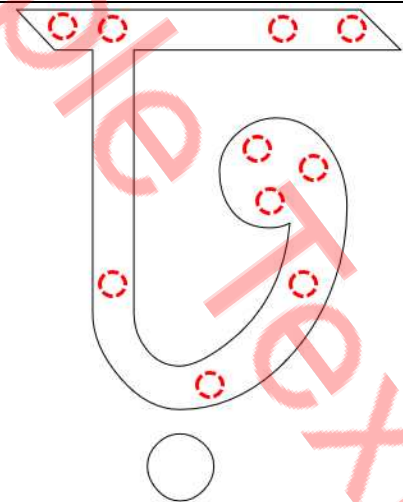
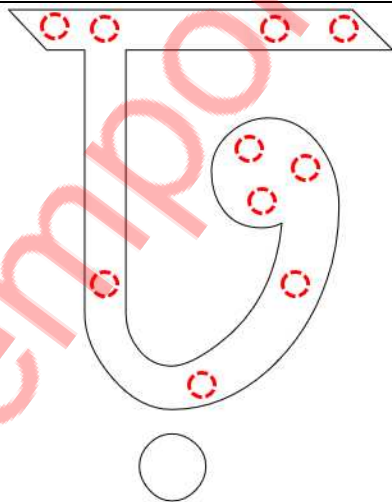

Student Name: \_\_\_\_\_

Verified By: \_\_\_\_\_

Class: \_\_\_\_\_

Date: \_\_\_\_\_

# Pick the Path Find the Correct Alphabet

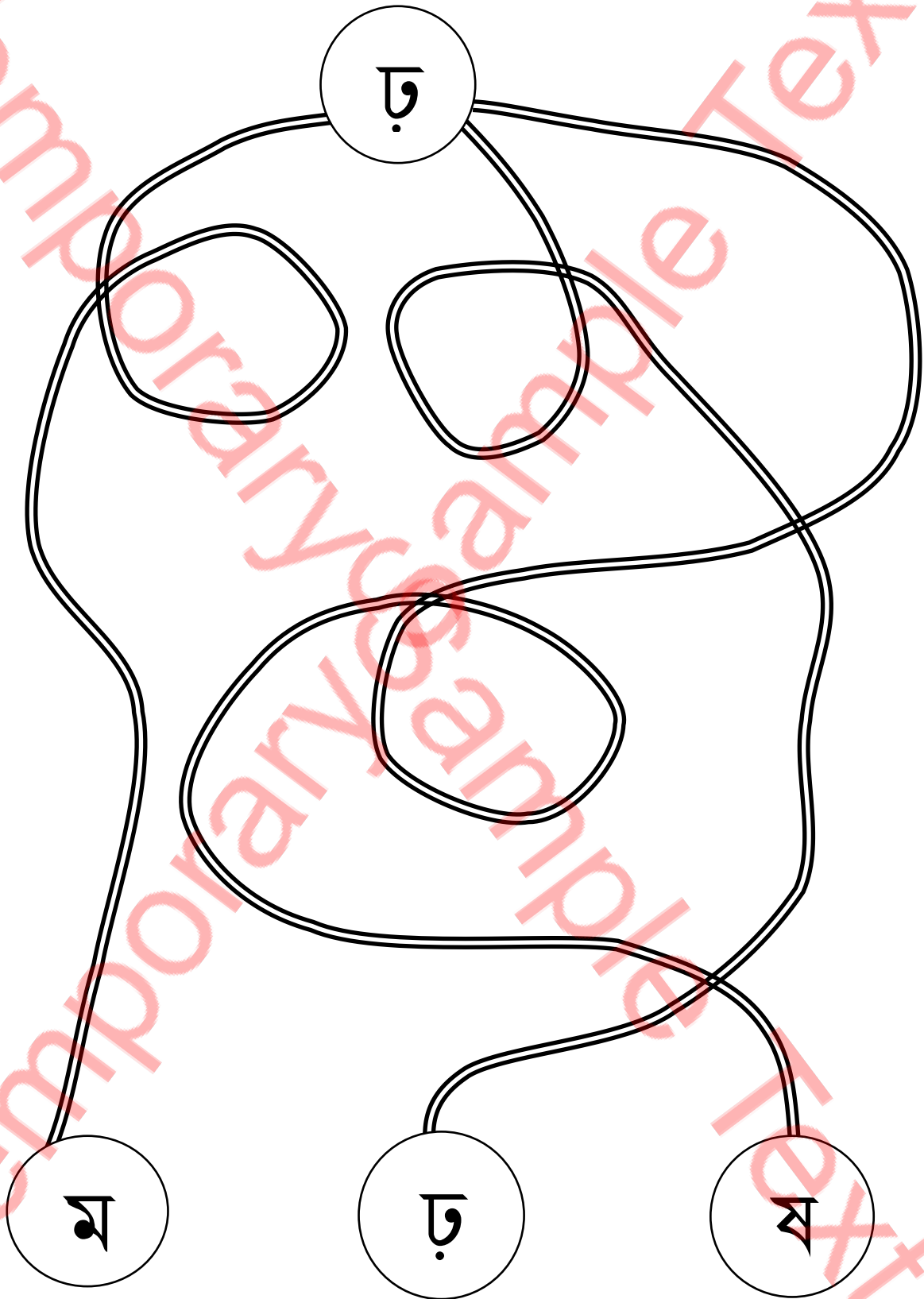

Student Name: \_\_\_\_\_

Verified By: \_\_\_\_\_

Class: \_\_\_\_\_

Date: \_\_\_\_\_



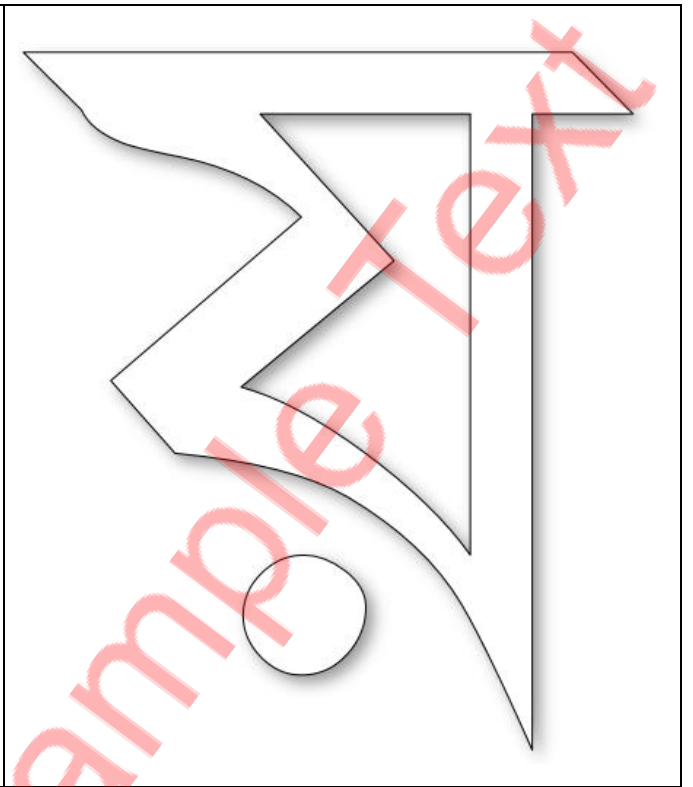
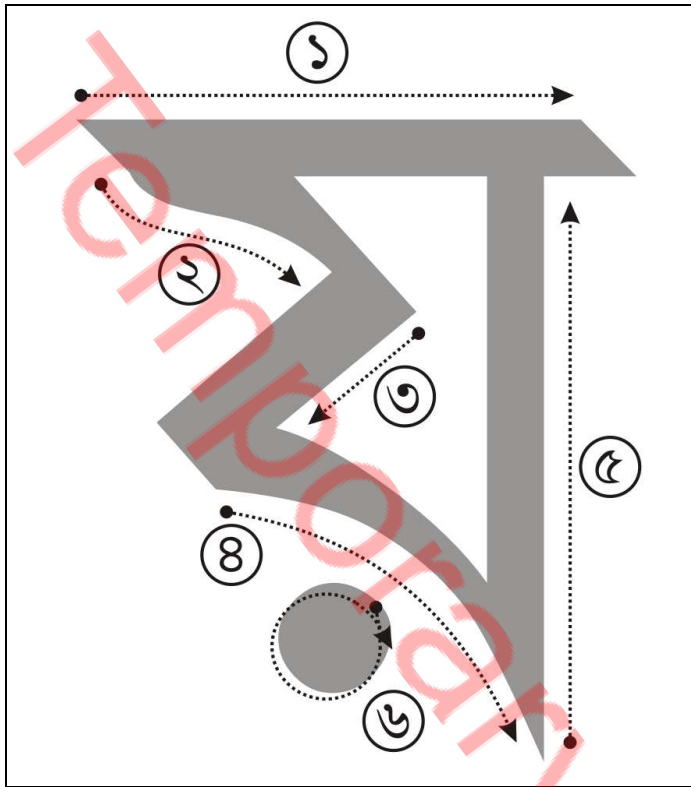

Follow the above steps

Colour it accordingly

ক	খ	গ	ঘ	ঙ	চ	ছ	জ
ঝ	ঞ	ট	ঠ	ড	ঢ	ণ	ত
থ	দ	ধ	ন	প	ফ	ব	ভ
ম	য	র	ল	শ	ষ	স	
হ	ক্ষ	ড়	ঢ়	য়	ং	ঃ	ঁ

Student Name: \_\_\_\_\_ Verified By: \_\_\_\_\_  
 Class: \_\_\_\_\_ Date: \_\_\_\_\_

# Trace It



Student Name: \_\_\_\_\_

Verified By: \_\_\_\_\_

Class: \_\_\_\_\_

Date: \_\_\_\_\_

# Trace it



Student Name: \_\_\_\_\_

Verified By: \_\_\_\_\_

Class: \_\_\_\_\_

Date: \_\_\_\_\_

Write it

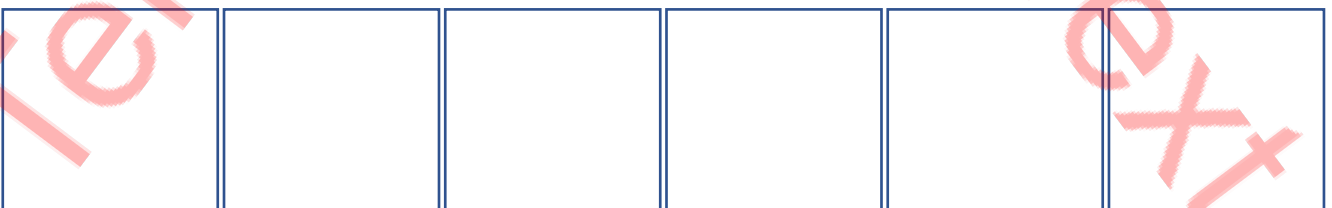
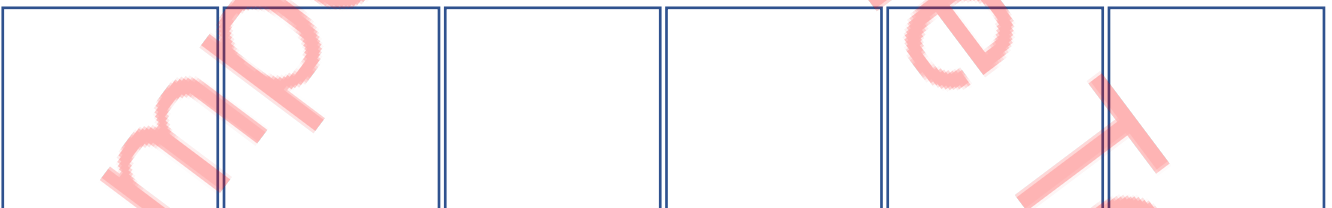
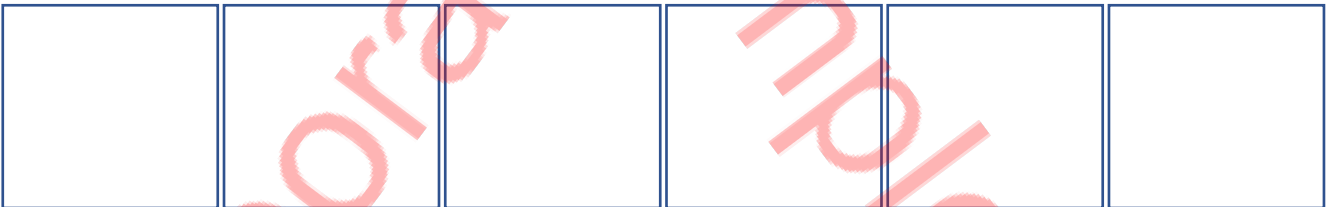
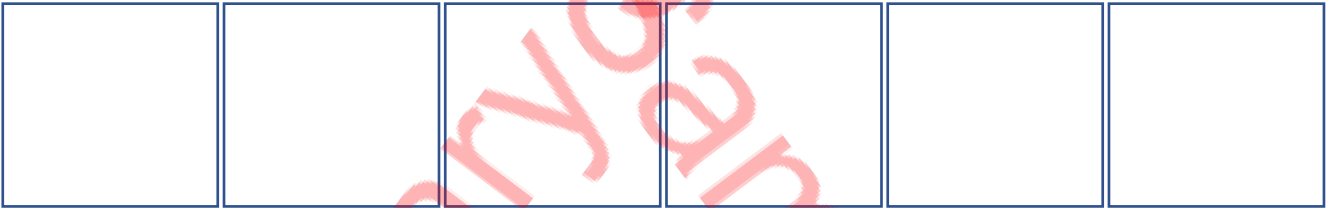
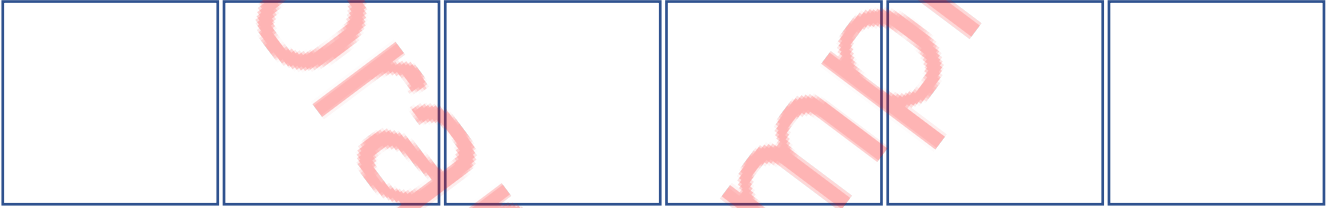
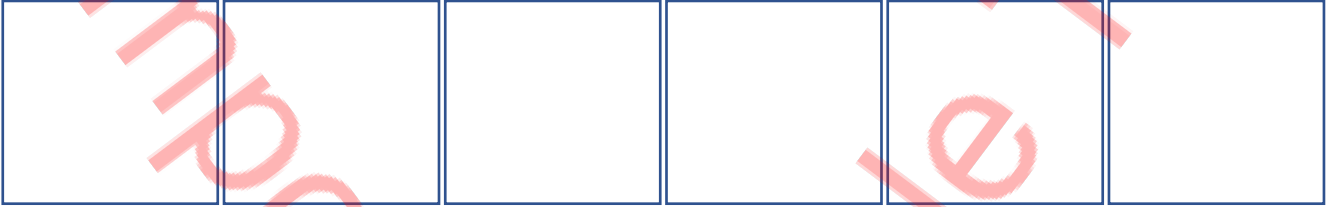
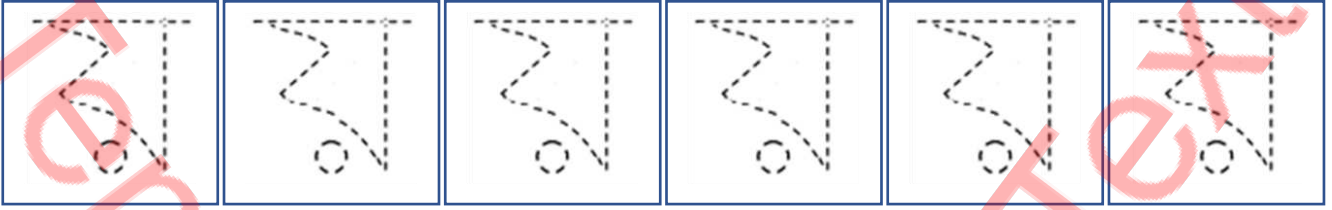

Student Name: \_\_\_\_\_

Verified By: \_\_\_\_\_

Class: \_\_\_\_\_

Date: \_\_\_\_\_

Copy Colour

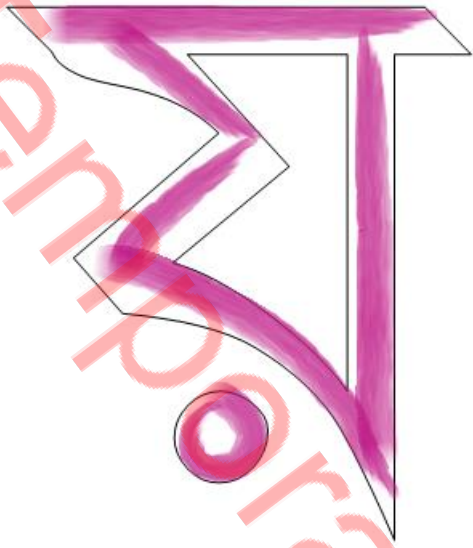

Colour it

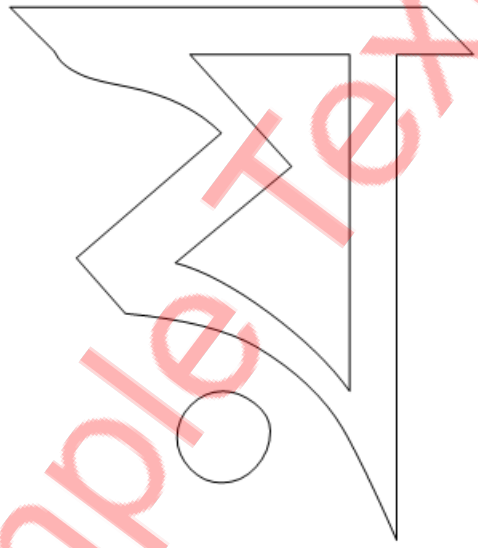

Write it

Find it

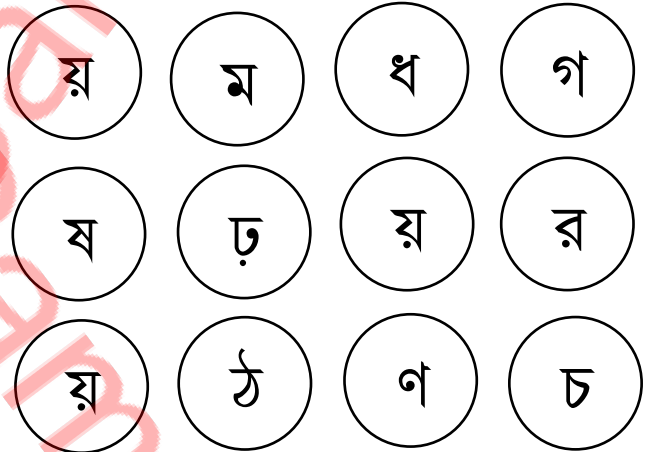
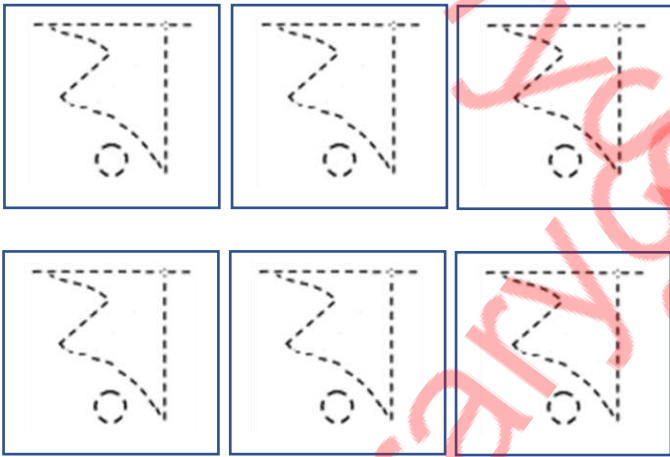

Connect the circle

Do it

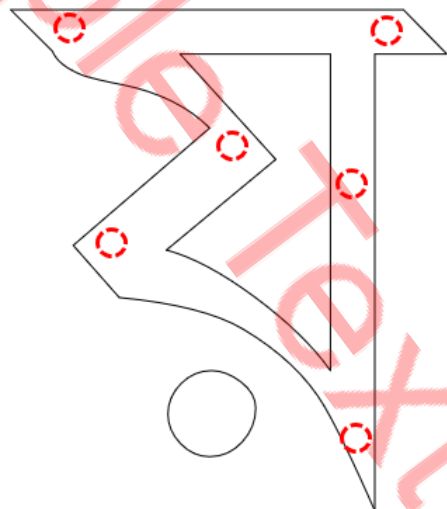
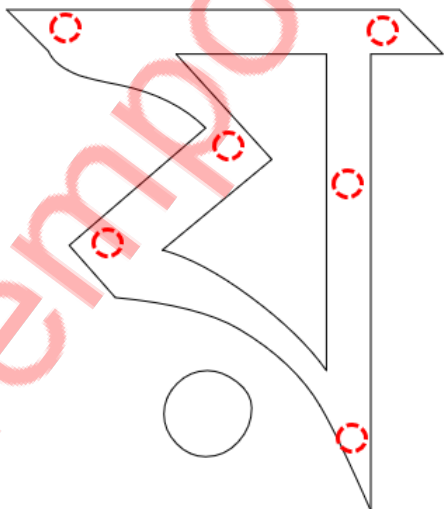

Student Name: \_\_\_\_\_

Verified By: \_\_\_\_\_

Class: \_\_\_\_\_

Date: \_\_\_\_\_

# Pick the Path Find the Correct Alphabet

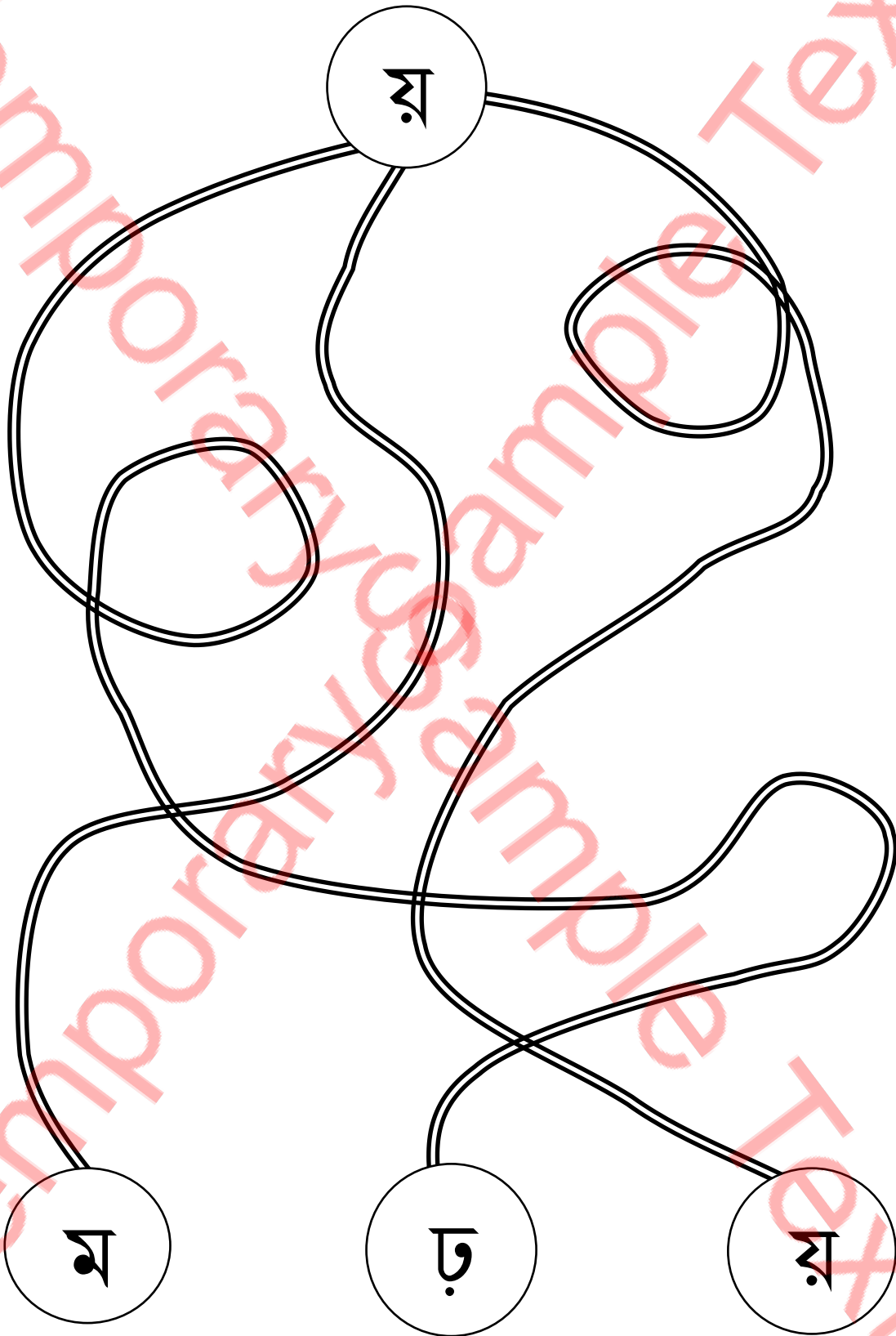

Student Name: \_\_\_\_\_

Verified By: \_\_\_\_\_

Class: \_\_\_\_\_

Date: \_\_\_\_\_



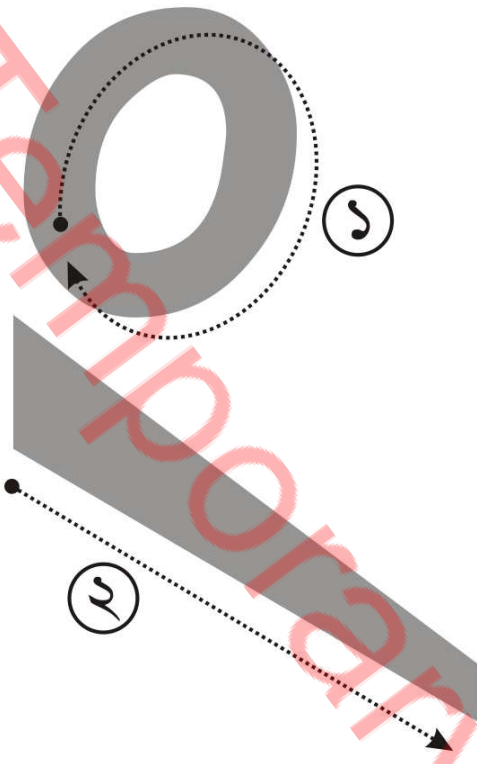

Follow the above steps

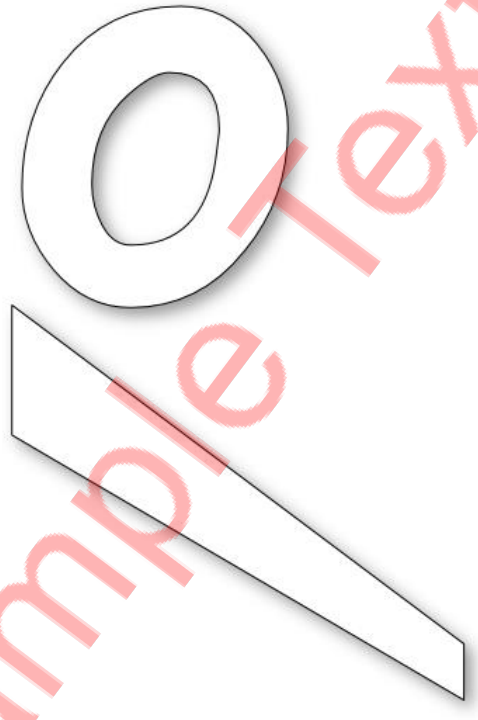

Colour it accordingly

ক	খ	গ	ঘ	ঙ	চ	ছ	জ
ঝ	ঞ	ট	ঠ	ড	ঢ	ণ	ত
থ	দ	ধ	ন	প	ফ	ব	ভ
ম	য	ষ	র	ৱ	শ	ষ	স
হ	ক্ষ	ড়	ঢ়	য়	ং	ঃ	ঁ

Student Name: _____	Verified By: _____
Class: _____	Date: _____

# Trace It

Student Name: \_\_\_\_\_

Verified By: \_\_\_\_\_

Class: \_\_\_\_\_

Date: \_\_\_\_\_

# Trace it



Student Name: \_\_\_\_\_

Verified By: \_\_\_\_\_

Class: \_\_\_\_\_

Date: \_\_\_\_\_

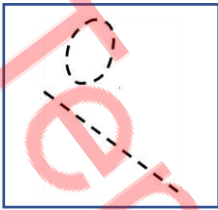
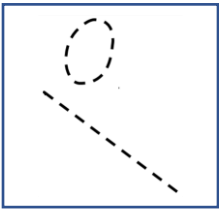
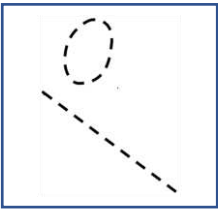
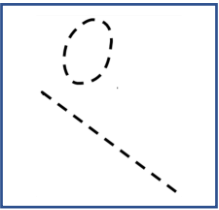
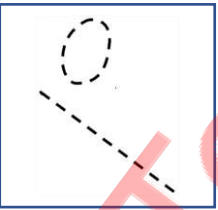
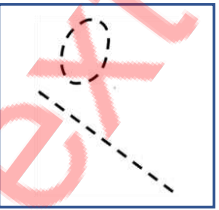
# Write it

Student Name: \_\_\_\_\_

Verified By: \_\_\_\_\_

Class: \_\_\_\_\_

Date: \_\_\_\_\_

Copy Colour

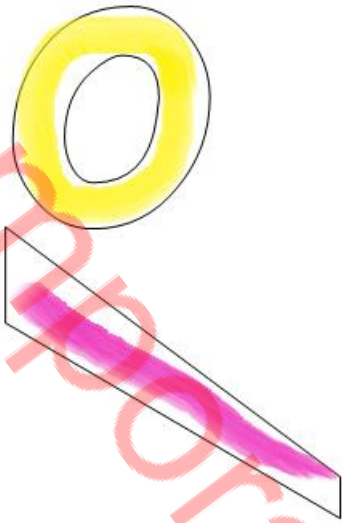

Colour it

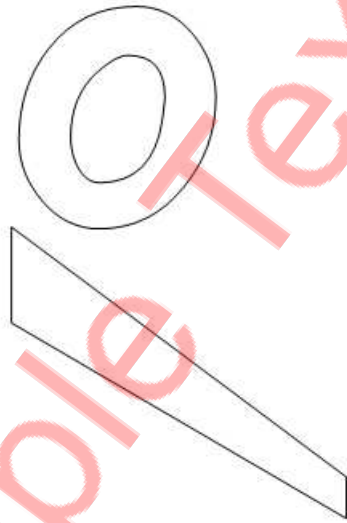

Write it

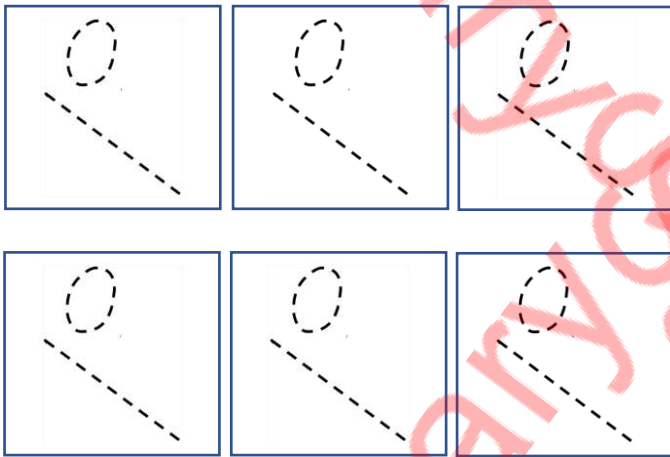

Find it

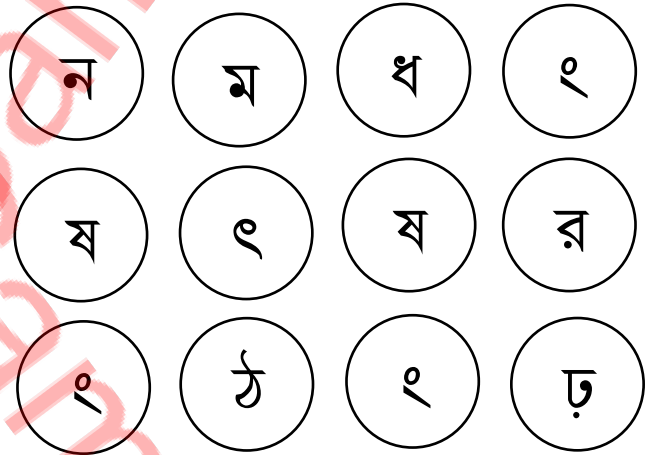

Connect the circle

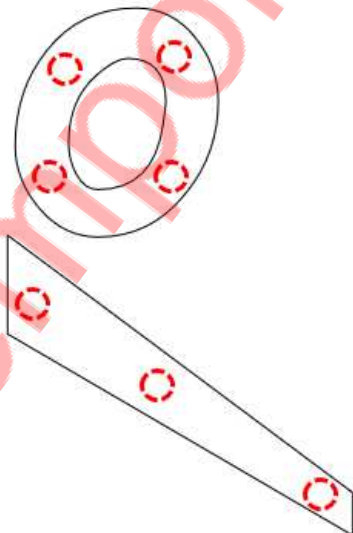

Do it

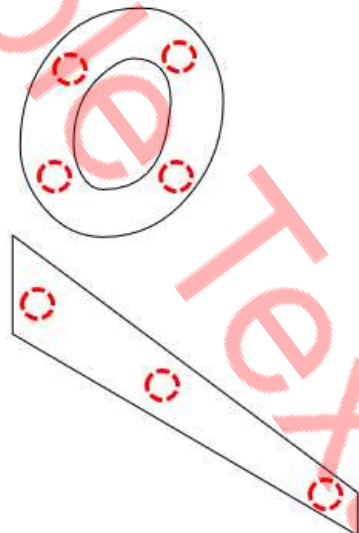

Student Name: \_\_\_\_\_

Verified By: \_\_\_\_\_

Class: \_\_\_\_\_

Date: \_\_\_\_\_

# Pick the Path Find the Correct Alphabet

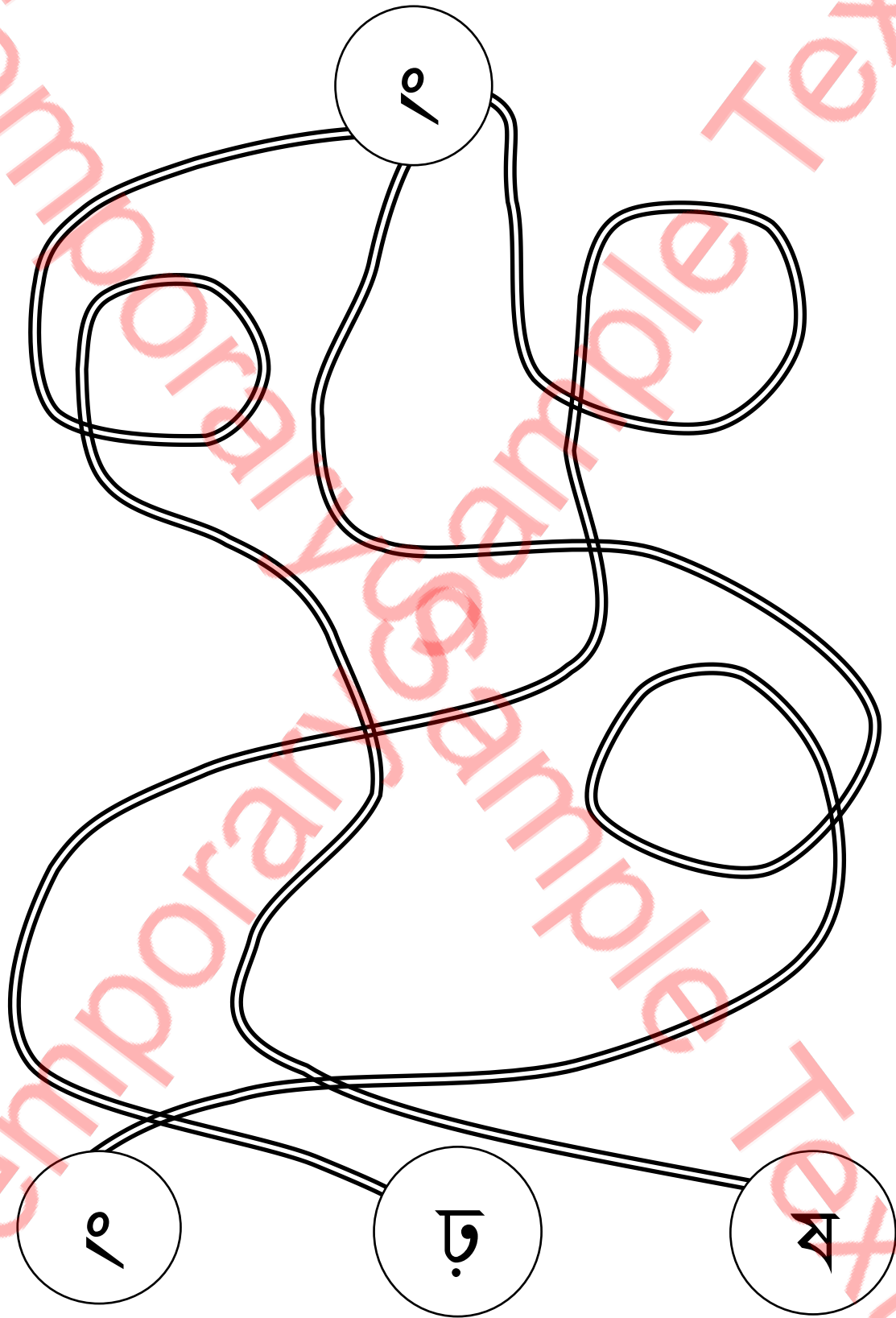

Student Name: \_\_\_\_\_

Verified By: \_\_\_\_\_

Class: \_\_\_\_\_

Date: \_\_\_\_\_



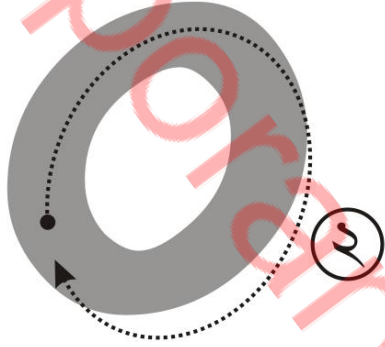
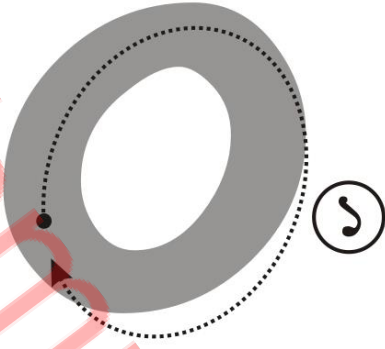

Follow the above steps

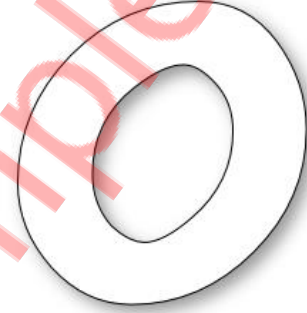

Colour it accordingly

ক	খ	গ	ঘ	ঙ	চ	ছ	জ
ঝ	ঞ	ট	ঠ	ড	ঢ	ণ	ত
থ	দ	ধ	ন	প	ফ	ব	ভ
ম	য	র	ল	শ	ষ	স	
হ	ক্ষ	ড়	ঢ়	য়	ং	ঃ	ঁ

Student Name: \_\_\_\_\_

Verified By: \_\_\_\_\_

Class: \_\_\_\_\_

Date: \_\_\_\_\_

# Trace It

o	o	o	o	o	o
o	o	o	o	o	o
o	o	o	o	o	o
o	o	o	o	o	o
o	o	o	o	o	o
o	o	o	o	o	o
o	o	o	o	o	o
o	o	o	o	o	o
o	o	o	o	o	o
o	o	o	o	o	o

Student Name: \_\_\_\_\_

Verified By: \_\_\_\_\_

Class: \_\_\_\_\_

Date: \_\_\_\_\_

# Trace it

o	o	o	o	o	o
o	o	o	o	o	o
o	o	o	o	o	o
o	o	o	o	o	o
o	o	o	o	o	o
o	o	o	o	o	o
o	o	o	o	o	o
o	o	o	o	o	o
o	o	o	o	o	o
o	o	o	o	o	o

Student Name: \_\_\_\_\_

Verified By: \_\_\_\_\_

Class: \_\_\_\_\_

Date: \_\_\_\_\_

## Write it

o	o	o	o	o	o
o	o	o	o	o	o

Student Name: \_\_\_\_\_

Verified By: \_\_\_\_\_

Class: \_\_\_\_\_

Date: \_\_\_\_\_

### Copy Colour



### Colour it

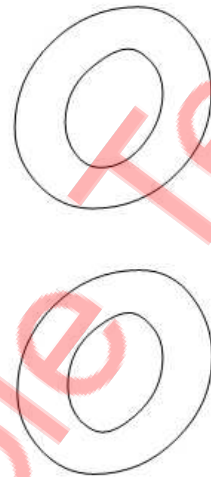

### Write it

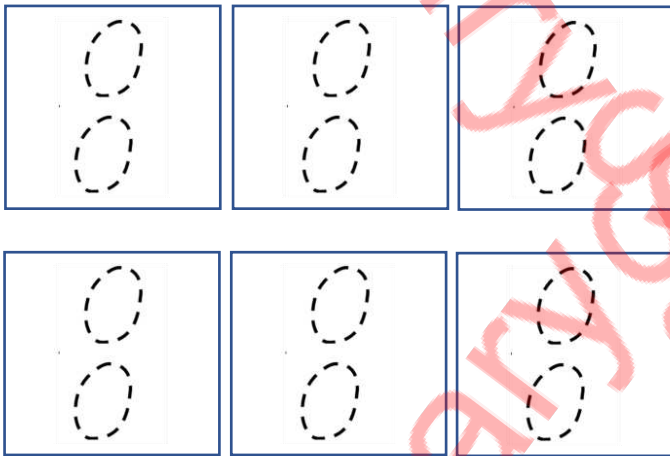

### Find it

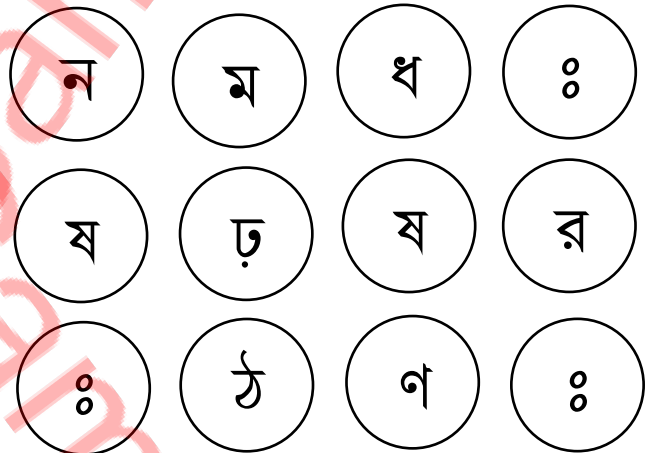

### Connect the circle

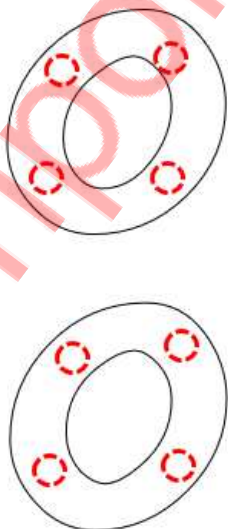

### Do it

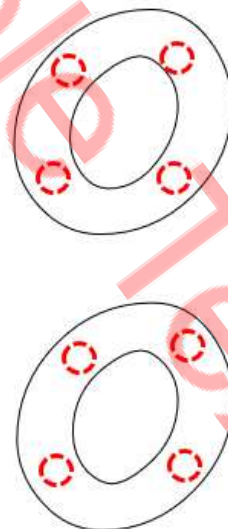

Student Name: \_\_\_\_\_

Class: \_\_\_\_\_

Verified By: \_\_\_\_\_

Date: \_\_\_\_\_

# Pick the Path Find the Correct Alphabet

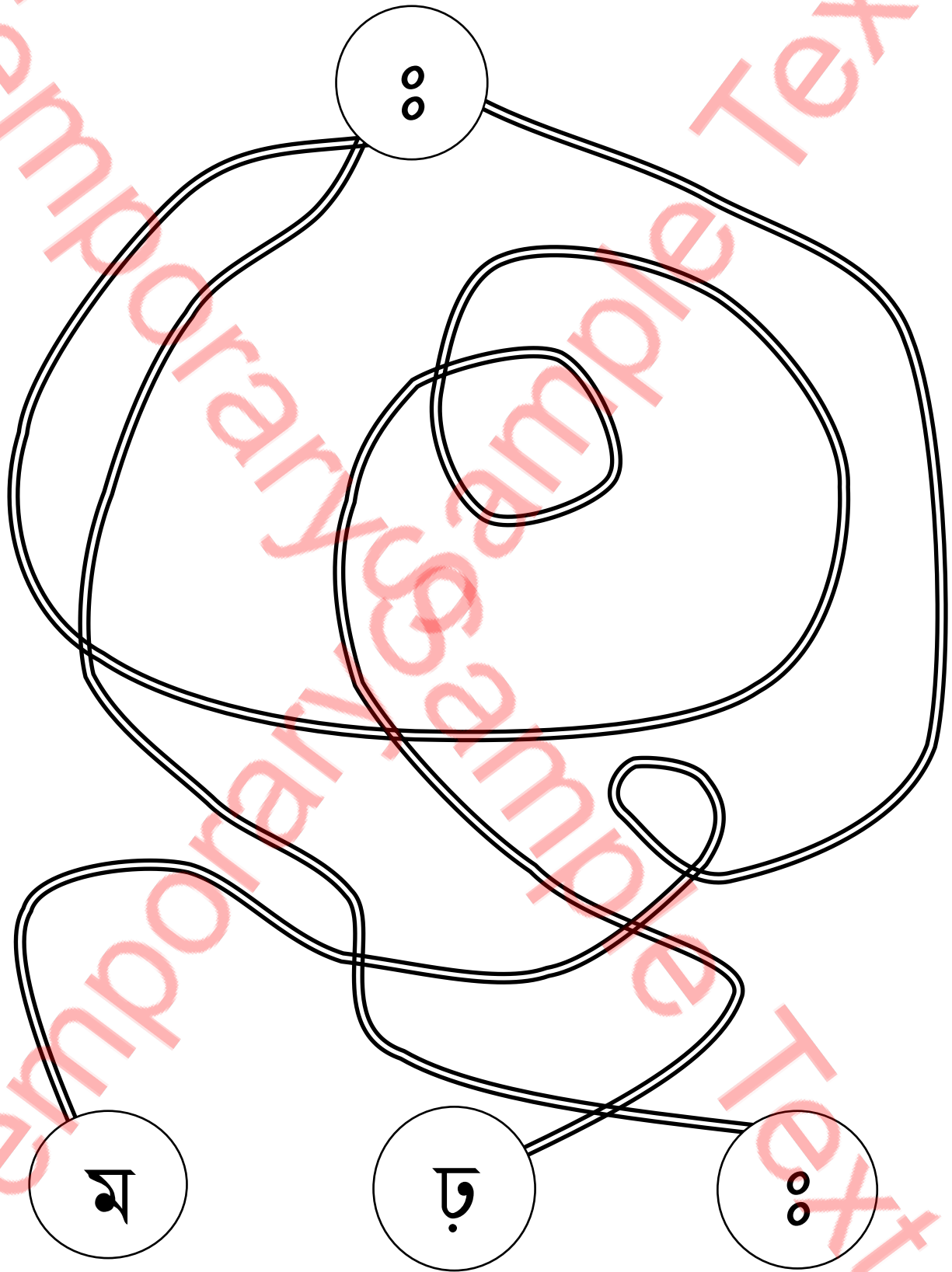

Student Name: \_\_\_\_\_

Verified By: \_\_\_\_\_

Class: \_\_\_\_\_

Date: \_\_\_\_\_



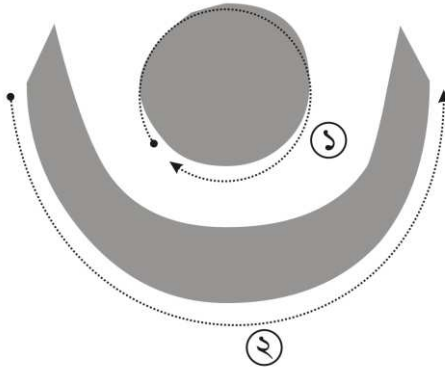

Follow the above steps

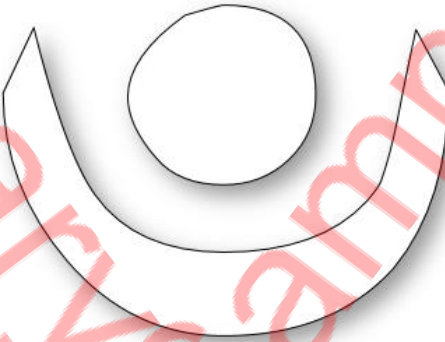

Colour it accordingly

ক	খ	গ	ঘ	ঙ	চ	ছ	জ
ঝ	ঞ	ট	ঠ	ড	ঢ	ণ	ত
থ	দ	ধ	ন	প	ফ	ব	ভ
ম	য	ষ	র	শ	ষ	স	
হ	ক্ষ	ড়	ড়	য়	ং	ঃ	ৎ

Student Name: \_\_\_\_\_

Verified By: \_\_\_\_\_

Class: \_\_\_\_\_

Date: \_\_\_\_\_

## Trace It



Student Name: \_\_\_\_\_

Verified By: \_\_\_\_\_

Class: \_\_\_\_\_

Date: \_\_\_\_\_

# Trace it



Student Name: \_\_\_\_\_

Verified By: \_\_\_\_\_

Class: \_\_\_\_\_

Date: \_\_\_\_\_

## Write it

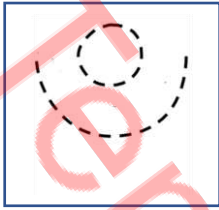
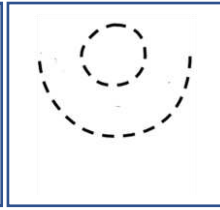
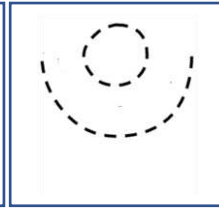
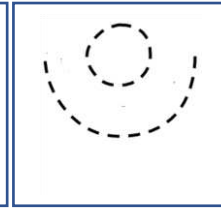
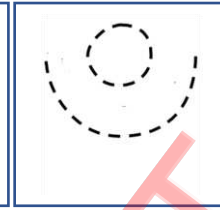
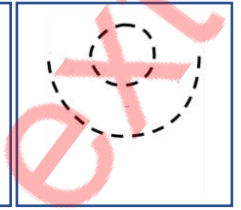
Student Name: \_\_\_\_\_

Verified By: \_\_\_\_\_

Class: \_\_\_\_\_

Date: \_\_\_\_\_

Copy Colour

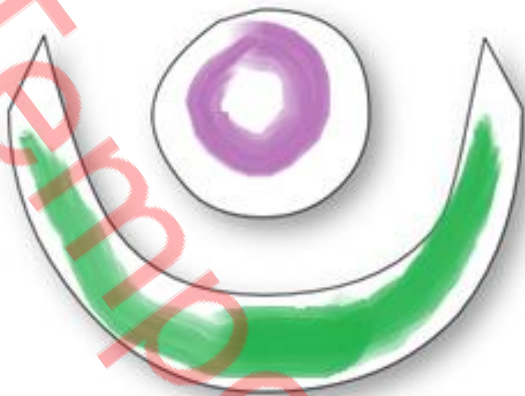

Colour it



Write it

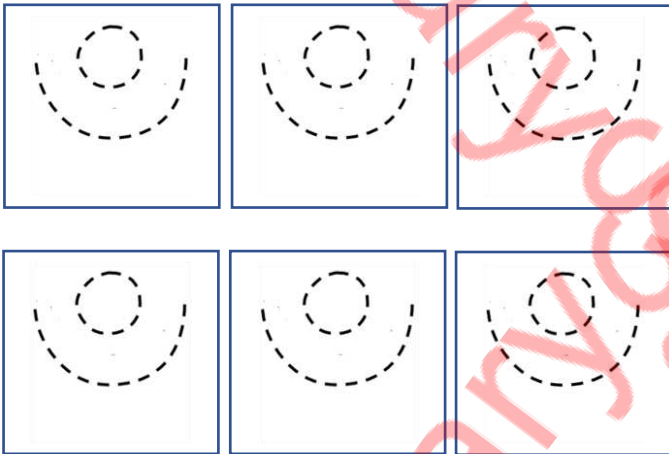

Find it

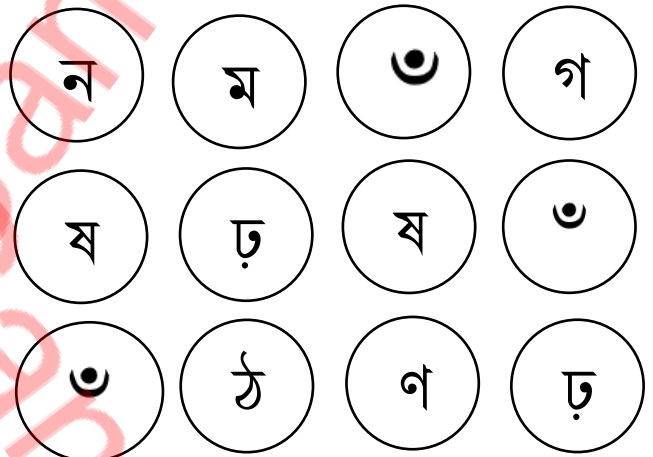

Connect the circle

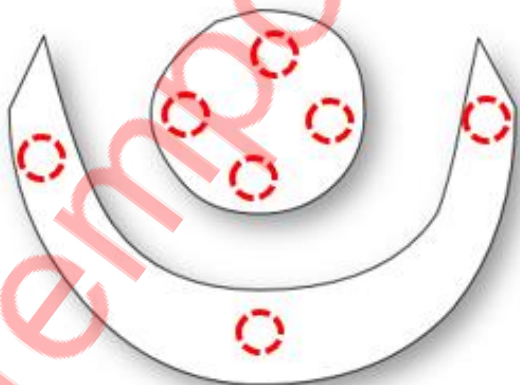

Do it



Student Name: \_\_\_\_\_

Verified By: \_\_\_\_\_

Class: \_\_\_\_\_

Date: \_\_\_\_\_

# Pick the Path Find the Correct Alphabet

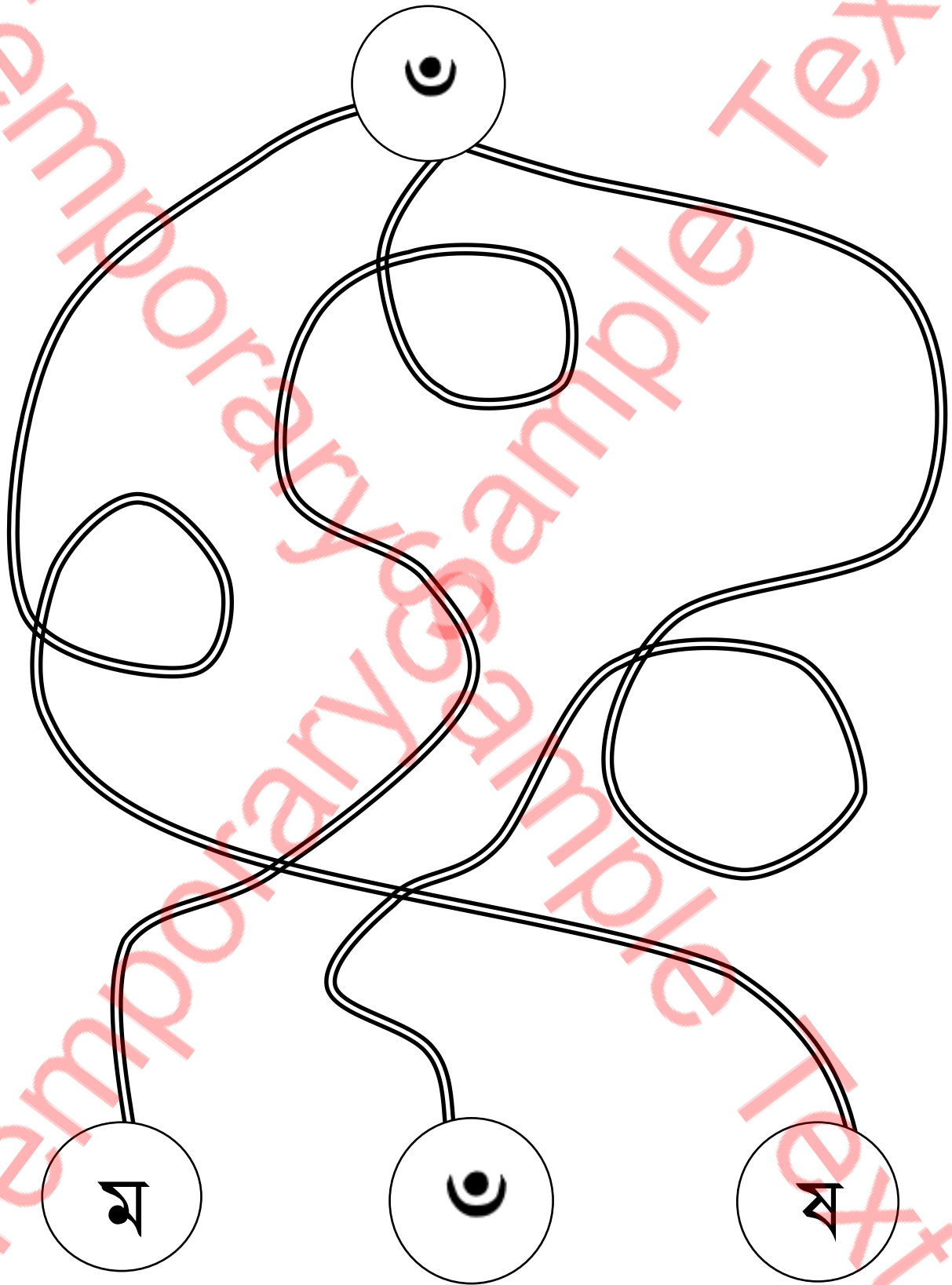

Student Name: \_\_\_\_\_

Verified By: \_\_\_\_\_

Class: \_\_\_\_\_

Date: \_\_\_\_\_